

Gigaset

A510 IP

Congratulations

By purchasing a Gigaset, you have chosen a brand that is fully committed to sustainability. This product's packaging is eco-friendly!

To learn more, visit www.gigaset.com.



GIGASET. INSPIRING CONVERSATION.
MADE IN GERMANY

Gigaset A510 IP – your high-quality accessory

Congratulations on your purchase of this latest generation Gigaset.

Your Gigaset can do a lot more than just make calls:

It's easy to configure your Gigaset thanks to the wizards

They help you to configure the VoIP connections for your phone and to assign the receive and send connections to the registered handsets.

You can perform the configuration with wizards on a handset or PC using the web configurator of your phone.

Your Gigaset is a real multi-line phone (it works like a PABX)

You can register up to six handsets. Assign each handset its own phone number.

Ethernet port

Connect your Gigaset to the Internet and your PC via Ethernet. Use your public and private directories on the Internet (→ [page 64](#)). Update the directory on your Gigaset and your directory on the PC simultaneously.

Directory for 150 entries

Save phone numbers and names to the directory (→ [page 61](#)). You can designate important entries as VIPs (Very Important Persons). VIP calls are then recognised by their ringtone and their background colour (→ [page 62](#)).

If you don't (always) want it to ring

Use time control for calls (→ [page 103](#)) or ensure that all calls from a withheld number are not signalled (→ [page 103](#)).

Other practical information

Transfer the directory from an existing Gigaset handset (→ [page 63](#)), use the shortcut function (→ [page 63](#)) and adjust the background colour and contrast of the display to your requirements (→ [page 100](#)).

Protecting our environment

Gigaset Green Home – be environmentally aware when using your phone. For details of our ECO DECT products, visit www.gigaset.com/service.

For more information about your phone, visit www.gigaset.com/gigasetA510IP.

After purchasing your Gigaset phone, please register it at www.gigaset.com/service – this will ensure that any questions you may have or warranty services you request are dealt with even faster!

If you have any questions about using your phone, please read the tips on troubleshooting (→ [page 144](#)) or contact our Customer Care team (→ [page 144](#)).

Have fun using your new Gigaset phone!

Contents

Gigaset A510 IP – your high-quality accessory	1
Overview	5
Display icons	6
Display keys	7
Main menu icons	7
The base at a glance	8
Safety precautions	9
First steps	10
Checking the package contents	10
Setting up the handset for use	11
Changing the display language	15
Installing the base station	16
Connecting the base	17
Setting up the phone – installation wizard	22
Date/time	33
Proceeding	34
Using the phone	35
Control key	35
Keys on the keypad	35
Correcting incorrect entries	35
Menu guidance	36
Activating/deactivating the handset	37
Activating/deactivating the keypad lock	37
Understanding the operating steps	38
Menu tree	40
Making calls	43
Making an external call	43
Ending a call	46
Accepting a call	46
Calling line identification	46
Notes on phone number display (CLIP)	47
VoIP telephony via Gigaset.net	48
Gigaset HDSP – telephony with brilliant sound quality	49
Activating/deactivating handsfree mode	50
Muting the handset	50
Making calls using select services	51
Configuring general settings for all calls	51
Configuring settings for the next call	54
Actions during an external call	54

Using lists	57
Redial list	57
Function of the message key	58
SMS inbox	59
Call list	59
Using directories	61
Local directory	61
Using online directories	64
Using the private net directory	68
Using the Gigaset.net directory	70
SMS (text messages)	74
Writing/sending SMS	74
Receiving SMS	77
Receiving notifications via SMS	80
Setting the SMS service centre/defining the send line	80
SMS on a PABX	81
Activating/deactivating SMS function	82
SMS troubleshooting	83
E-mail notifications	84
Opening the incoming e-mail list	85
View the message header of an e-mail	87
Viewing e-mail sender's address	87
Deleting e-mail messages	87
Using the network mailbox	88
Activating/deactivating network mailboxes, entering numbers	88
Configuring a network mailbox for fast access	89
ECO DECT	91
Using the handset as an alarm clock	93
Using multiple handsets	94
Registering handsets	94
De-registering handsets	95
Locating a handset ("paging")	95
Making internal calls	96
Changing the name of a handset	98
Changing a handset's internal number	98
Handset settings	99
Changing the display language	99
Setting the display/screensaver	99
Configuring the display/colour and contrast	100
Quickly accessing functions	100
Activating/deactivating auto answer	101
Changing the handsfree/earpiece volume	101
Changing ringtones	102
Restoring the handset default settings	104

- Setting the base** 105
 - Setting the date/time 105
 - Protecting the telephone from unauthorised access 105
 - Activating/deactivating music on hold 106
 - Setting the base's IP address in the LAN 106
 - Configuring VoIP connections, assigning send and receive connections 108
 - Automatic update for the VoIP provider settings 109
 - Updating the phone firmware 109
 - Repeater support 110
 - Restarting the base 111
 - Resetting the base to the default settings 111
 - Checking the base MAC address 112
- Connecting the base station to the PABX** 113
 - Recall (fixed line) 113
 - Saving an access code (outside line code) 113
 - Setting pauses 114
 - Switching temporarily to tone dialling (DTMF) 115
- Configuring the phone via the Web configurator** 116
 - Connecting the PC with the telephone's Web configurator 117
 - Logging into/off the Web configurator 119
 - Understanding the structure of the Web configurator pages 121
 - Web configurator menu 125
 - Functions of the Web configurator 126
- Customer Service & Assistance** 142
 - Questions and answers 144
 - Information on operating Gigaset VoIP telephones with routers with Network Address Translation (NAT) 147
 - VoIP status codes 149
 - Checking service information 152
 - Authorisation 153
- Environment** 153
- Appendix** 155
 - Caring for your telephone 155
 - Contact with liquid 155
 - Specifications 155
 - Writing and editing text 157
- Glossary** 159
- Accessories** 172
- Mounting the base on the wall** 176
- Mounting the charger on the wall** 176
- Index** 177

Overview

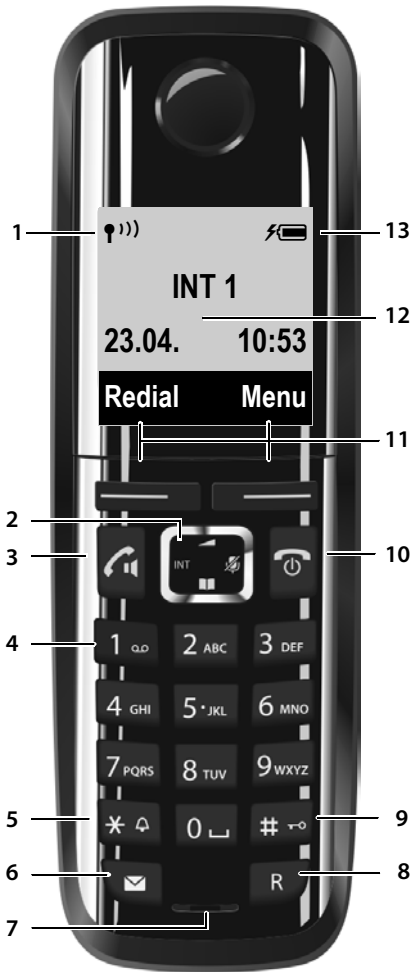

- 1 **Signal strength** (→ [page 33](#))
Icon changes when Eco Mode+ is activated (→ [page 91](#))
- 2 **Control key** (→ [page 35](#))
Mute microphone (→ [page 50](#))
- 3 **Talk/Handsfree key**
Flashing: incoming call;
Lights up: handsfree mode activated; accept call; in idle status: open redial list (press briefly);
open connection list (press and hold; → [page 43](#));
When writing an SMS: send SMS
During a call: Switch from earpiece to hands-free mode (→ [page 50](#))
- 4 **Key 1**
Dial network mailbox (press and hold)
- 5 **Star key**
Ringtones on/off (press and hold);
With an open connection: switch from pulse dialling to tone dialling (press briefly)
- 6 **Message key** (→ [page 58](#))
Access to calls and message lists;
Flashing: new message or new call
- 7 **Microphone**
- 8 **Recall key**
- Consultation call (flash)
- Insert a dialling pause (press and hold)
- 9 **Hash key**
Keypad lock on/off (press and hold in idle status);
toggles between upper/lower case and digits
- 10 **End call key, On/Off key**
End call; cancel function; go back one menu level (press briefly); back to idle status (press and hold); activate/deactivate handset (press and hold in idle status)
- 11 **Display keys** (→ [page 7](#))
- 12 **Display** in idle status
- 13 **Charge status of the batteries** (→ [page 33](#))

Please note

To change the display language, proceed as described on [page 15](#) and [page 99](#).

Display icons

The following icons are displayed depending on the settings and the operating status of your telephone:

Signal strength **📶** (→ [page 33](#))
 or Eco Mode + icon **🔋** (→ [page 91](#))

Keypad locked (→ [page 37](#))

Ringtone switched off (→ [page 103](#))

Batteries are charged (→ [page 33](#))

Charge status of the batteries (→ [page 33](#))

INT 1 — Name of the handset (→ [page 98](#))

23.04. 10:53 — Current day/current time (→ [page 33](#))

INT 1

🕒 12:00 10:53 — Alarm clock switched on and wake-up time set (→ [page 93](#))

📧 📞 📧 — Number of new messages:
 ♦ **📧** On the network mailbox (→ [page 58](#))
 ♦ **📞** In the missed calls list (→ [page 58](#))
 ♦ **📧** In the SMS list (→ [page 61](#)), e-mail list (→ [page 85](#))

Redial ◊ Menu — Display keys (→ [page 7](#))

Display during external call:

📞 ◊ 📞 01 — VoIP connection established (↔️ for fixed line connection)
 — For VoIP connections: number of VoIP line (01 – 06)

1234567890 — Number (or name) of caller

00:00:53 — Call duration

Menu — Display key (→ [page 7](#))
 ♦ Set call volume (→ [page 101](#))
 ♦ Access service information

Other display icons:

Establishing a connection



Connection established



Connection cannot be established or connection interrupted



External call (→ [page 46](#))



Internal call (→ [page 96](#))



Alarm call (→ [page 93](#))



Information



Query



Please wait...



Action complete



Action failed



Display keys

The functions of the display keys change depending on the operating situation.
Example:

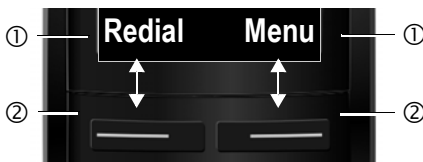

- ① Current display key function
- ② Display keys

Important display keys:

Redial	Open redial list.
Menu	Open a menu for further functions.
OK	Confirm selection.
Del.	Delete key: delete one character at a time from right to left.
Back	Skip back one menu level or cancel operation.

Main menu icons

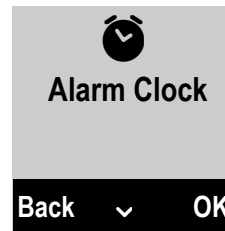

- SMS
- Alarm Clock
- Select Services
- Online Contacts
- Voice Mail (Network mailbox)
- Settings

Information on using the menus

→ [page 36](#)

Menu overview → [page 40](#)

The base at a glance

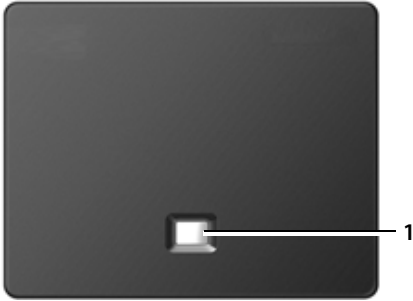

Base key

1 **Paging key**

Lights up:

LAN connection active (phone is connected to router)

Flashes:

Data transfer to LAN connection

Press **briefly**:

Start paging, display IP address on handset

Press and **hold**:

Set base to registration mode

Safety precautions

Warning

Read the safety precautions and the user manual before use.

Explain their content and the potential hazards associated with using the telephone to your children.



Use only the power adapter supplied, as indicated on the underside of the base.



Use only **rechargeable batteries** that correspond to the **specification provided on page 155**, as this could otherwise result in significant health risks and personal injury.



Using your telephone may affect nearby medical equipment. Be aware of the technical conditions in your particular environment, e.g., doctor's surgery. If you use a medical device (e.g., a pacemaker), please contact the device manufacturer. They will be able to advise you regarding the susceptibility of the device to external sources of high frequency energy. Please refer to the "Appendix" chapter for the specifications of this Gigaset product.



Do not hold the rear of the handset to your ear when it is ringing or when handsfree mode is activated. Otherwise you risk serious and permanent damage to your hearing.

Your Gigaset is compatible with the majority of digital hearing aids on the market. However, perfect function with all hearing aids cannot be guaranteed.

The handset may cause interference in analogue hearing aids. If you require assistance, please contact the hearing aid supplier.



Do not install the base or charger in bathrooms or shower rooms. The base and charger are not splashproof (→ **page 155**).



Do not use your phone in environments with a potential explosion hazard (e.g., paint shops).



If you give your phone to a third party, make sure you also give them the user guide.



Remove faulty bases from use or have them repaired by our Service team, as these could interfere with other wireless services.

Please note

- ◆ Not all of the functions described in this user guide are available in all countries.
- ◆ The device cannot be used in the event of a power failure. It is also **not** possible to transmit **emergency calls**.

First steps

Checking the package contents



- 1 **One Gigaset A510 IP base**
- 2 **One power cable for connecting the base to the mains power supply**
- 3 **One phone cable to connect the base to the analogue fixed line (TAE RJ11 6-pole; flattened cable) 3a or 3b, depending on the country/provider.**
- 4 **One Ethernet (LAN) cable (Cat 5 with 2 RJ45 modular jacks) for connecting the base to a router (LAN/Internet)**
- 5 **One Gigaset A510H handset**
- 6 **Two batteries for the handset (uncharged)**
- 7 **One battery cover for the handset**
- 8 **One handset charger**
- 9 **One power adapter for connecting the charger to the mains power supply**
- 10 **One quick guide and a CD**

Firmware updates

Whenever there are new or improved functions for your Gigaset, firmware updates are made available for you to download to your base (→ **page 109**). If this results in operational changes when using your phone, a new version of this user manual or the necessary amendments will be published on the Internet at

www.gigaset.com/gigaset510ip.

Information on the firmware currently loaded → **page 152**.

Setting up the handset for use

The display is protected by a plastic film.

Please remove the protective film!

Inserting the batteries and closing the battery cover

Warning

Use only rechargeable batteries (→ **page 155**) recommended by Gigaset Communications GmbH i.e., never use a conventional (non-rechargeable) battery, as this could result in significant health risks and personal injury. For example, the outer casing of the batteries could be damaged or the batteries could explode. The phone could also malfunction or be damaged as a result of using batteries that are not of the recommended type.

First steps

- ▶ Insert the batteries with the polarity in the correct direction. The polarity is indicated in the battery compartment.

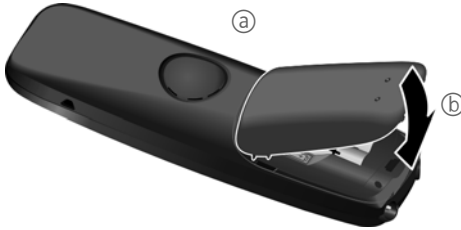

- ▶ First insert the battery cover at the top (a).
- ▶ Then press the cover (b) until it clicks into place.

To open the battery cover, for instance to replace the batteries, insert a coin into the cavity on the casing, then pull the battery cover in an upward direction.



Connecting the charging cradle

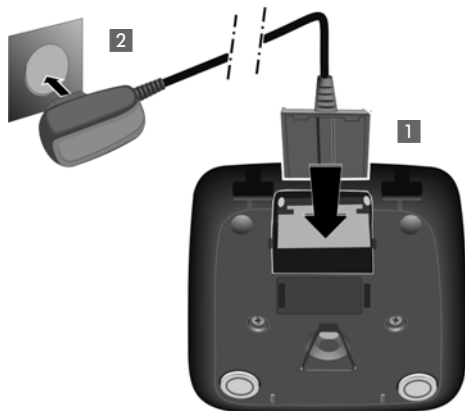

- ▶ Connect the flat plug from the power adapter **1**.
- ▶ Plug the power adapter into the plug socket **2**.

To disconnect the plug from the charger, press the release button **3** and disconnect the plug **4**.



Placing the handset in the charger

- ▶ Place the handset in the charger with its **display facing forward**.

Each handset is registered with the base at the factory. You do not need to register the handsets again. If you wish to use your handset with a different base or use additional handsets with your base, you have to register the handset manually

→ [page 94](#).

To charge the batteries, leave the handset in the charger.

Please note

Only place the handset in the charger that is intended for it.

Initial charging and discharging of the batteries

The correct charge level can only be displayed if the batteries are first fully charged and discharged.



- ▶ Charge the handset for **6.5** hours in the charger.
- ▶ Then remove the handset from the charger and **do not** replace it until the batteries are **fully discharged**.

Please note

- ◆ The handset is pre-registered with the base. If you have purchased a **model with multiple handsets**, all handsets will already be registered with the base. You do not need to register the handsets again. However, if a handset is not registered with the base (**Register handset** flashes on the display), register the handset manually → [page 94](#).
- ◆ After the first battery charge **and** discharge, you may place your handset in the charger after every call.
- ◆ Always repeat the charging and discharging procedure if you remove the batteries from the handset and reinsert them.
- ◆ The batteries may warm up during charging. This is not dangerous.
- ◆ After a while, the charge capacity of the batteries will decrease for technical reasons.

Changing the display language

Change the display language if you do not understand the language currently set.

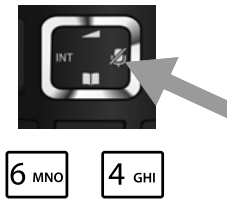

- ▶ Press right on the control key.
- ▶ Press the keys **6 MNO** and **4 GHI** **slowly** one after the other.

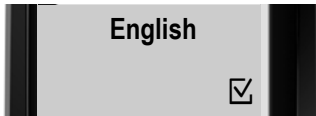

The display for setting languages appears and the current language (e.g., English) is selected.

- ▶ Press down on the control key ...



... until the language you wish to use is displayed e.g., French.



- ▶ Press the key below **OK** to select this language.

The selection is marked with .



- ▶ Press and **hold** the end call key to return to idle status.

Installing the base station

The base station is designed for use in dry rooms in a temperature range of +5°C to +45°C.

- ▶ Set up the base at a central point in the building.

Please note

Pay attention to the range of the base. This is up to 300 m in unobstructed outdoor areas and up to 50 m inside buildings. The range is reduced when **Eco Mode** is activated (→ **page 91**).

The phone's feet do not usually leave any marks on surfaces. However, due to the multitude of different varnishes and polishes used on today's furnishings, the occurrence of marks on the surfaces cannot be completely ruled out.

Warning

- ◆ Never expose the telephone to any of the following: heat sources, direct sunlight or other electrical appliances.
- ◆ Protect your Gigaset from moisture, dust, corrosive liquids and fumes.

Connecting the base

The following diagram is an overview of all connections for your base. The individual connections are described in detail below. In order for you to make calls on your phone via the fixed line and VoIP, you need to connect the base to the fixed line and Internet (see diagram below).

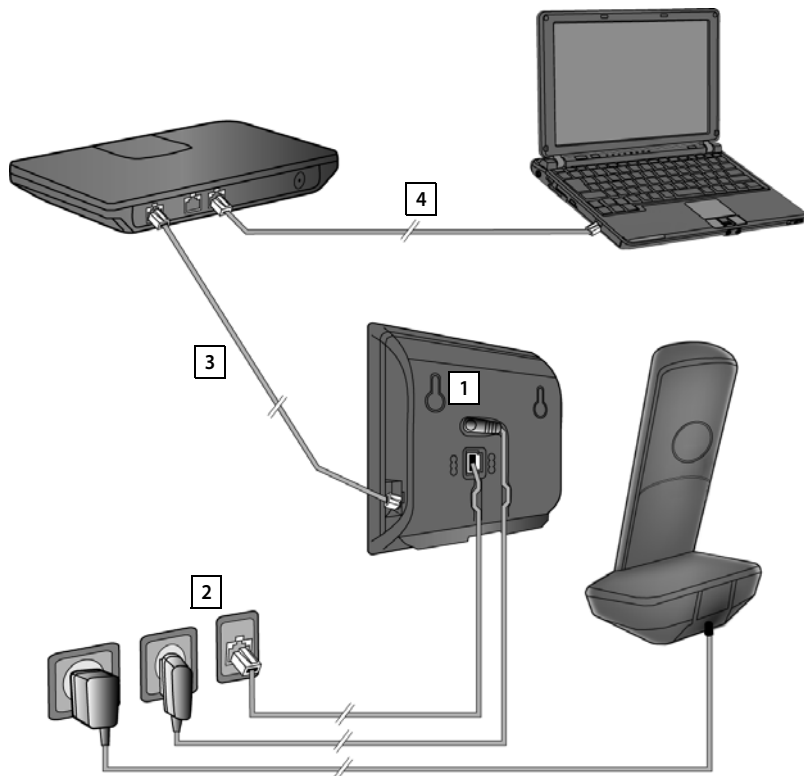

Follow the steps in the order given below:

- 1** Connect the phone and power cables to the base.
- 2** Connect the base to the telephone network and the mains power supply.
- 3** Connect the base to the router for accessing the Internet (via router and modem or via router with integrated modem) and for configuring the base via the Web configurator.
- 4** Connect the PC to the router.

1. Connecting the phone and power cables to the base

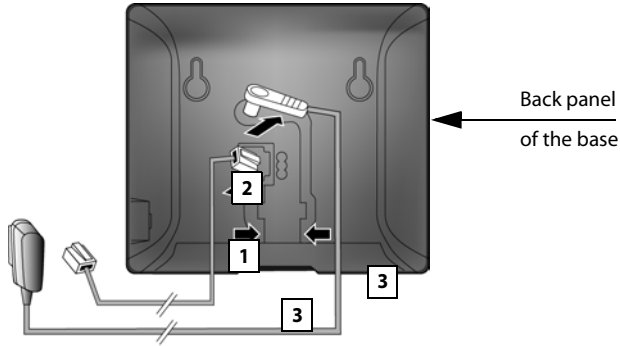

- 1 Insert the phone cable (TAE connection cable with RJ11 plug) into the lower connection socket at the rear of the base.
- 2 Insert the power cable of the power adapter into the upper connection socket at the rear of the base.
- 3 Push both cables into the appropriate cable channels.

Warning

Use only the power and telephone cables **supplied**. Pin connections on telephone cables can vary (pin connections → [page 157](#)).

2. Connecting the base to the fixed line and the mains power supply

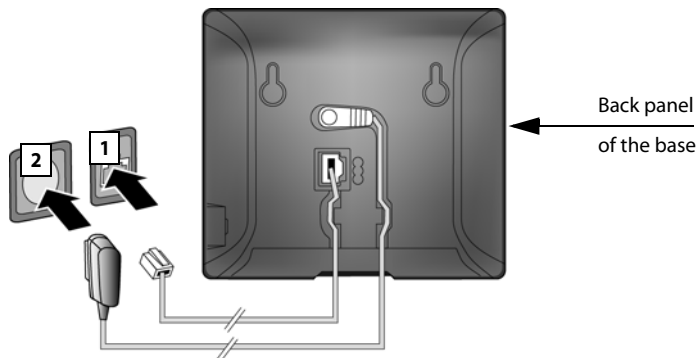

- 1 Insert the phone cable into the fixed line connection socket.
- 2 **Then** insert the power adapter into the mains socket.

Warning

Keep the power cable **plugged in at all times** for operation, as the phone does not work without a mains connection.

You can now use your phone to make calls via the fixed line and can be reached on your fixed line number.

3. Connecting the base to a router (Internet)

Data protection notice

When the device is connected to the router, it automatically contacts the Gigaset support server to make it easier for you to configure the devices and to enable communication with the Internet services.

For this purpose, every device sends the following device-specific information once every day:

- ◆ Serial number/item number
- ◆ MAC address
- ◆ Private IP address for the Gigaset in the LAN/its port numbers
- ◆ Device name
- ◆ Software version

On the support server, this information is linked to the existing device-specific information:

- ◆ Gigaset.net phone number
- ◆ System-related/device-specific passwords

Further information about the Gigaset.net service data saved can be found at:
www.gigaset.net/privacy-policy

Your base features a LAN connection that you can use to connect the base to a router.

Connection to a router is required for Internet telephony VoIP (Voice over Internet Protocol). You can set up and configure up to six accounts (VoIP phone numbers) from one or more VoIP provider(s) of your choice on the phone.

You also need a connection to the router for the following features on your phone:

- ◆ If you want to be notified as soon as new software is available for your phone on the Internet.
- ◆ If you want the date and time on your phone to be updated by a time server on the Internet.
- ◆ If you want to use info services (e.g., weather forecasts) and/or online directories on your phone.

You can also connect a PC to the router if you want to set your phone via its Web configurator.

For Internet access you need a router connected to the Internet via a modem (this may be integrated in the router).

Please note

For telephony via the Internet, you need a broadband Internet connection (e.g., DSL) with flat rate (recommended) or volume rate and a router that connects your phone to the Internet. You can find a list of recommended routers on the Internet at:

www.gigaset.com/service

From here, go to the FAQ page and select your Gigaset IP telephone. Search for "Router", for example.

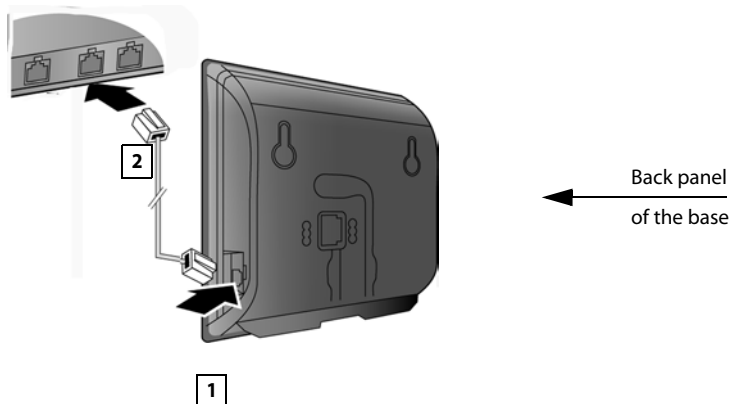

- 1 Insert a plug from the Ethernet cable supplied (Cat 5 with 2 RJ45 Western modular plugs) into the LAN connection socket at the side of the base.
- 2 Then insert the second Ethernet cable plug into a LAN socket on the router.

As soon as the cable connecting the phone and router is plugged in and the router is switched on, the button lights up on the front of the base (paging button).



You are now able to establish VoIP connections within Gigaset.net
(→ [page 48](#)).

Setting up the phone – installation wizard

Auto configuration:

The configuration process for VoIP connections is automated for some VoIP providers. The provider creates a configuration file with all required VoIP access data (the general VoIP provider data and your personal account data). This file is placed on a configuration server on the Internet for downloading to your phone.

Your provider gives you a configuration code.

The installation wizard on your phone (→ [page 23](#)) prompts you to enter the code at the relevant point. All the required VoIP data is then downloaded automatically onto your phone.

The configuration file is only transferred via a secure connection (TLS authentication). If the TLS authentication fails, the message key  flashes. Press the message key to display the message **Certificate error Please check certificates in the web configurator**. Press the right display key to confirm the message.

Log in to the Web configurator (→ [page 119](#)).

The Web page **Security** (→ [page 127](#)) tells you why the secure connection could not be established and what you can do.

If the configuration file fails to download (e.g., because the configuration server is not available), the phone keeps trying to establish a connection until the file is downloaded successfully to the phone.

If no VoIP connections have been generated on the phone yet and the wizard has not been started, you can start the installation wizard. The wizard allows you to make all necessary settings for your phone.

Two individual wizards are combined to form the installation wizard:

- 1 VoIP wizard
- 2 Connection wizard

Launching the installation wizard



As soon as the handset battery is sufficiently charged, the message key (✉) on the handset will flash (approx. 20 minutes after you have put the handset in the charger).

- ▶ Press the message key (✉).

1. VoIP wizard – making VoIP settings

You will see the following display:

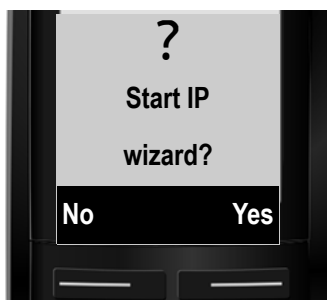

Before you can use VoIP to phone any other numbers over the Internet, the fixed line or the mobile network, you need the services of a VoIP provider which supports the VoIP SIP standard.

Prerequisite: You have registered with a VoIP provider (e.g., via your PC) and set up at least one VoIP account (IP account).

To use VoIP, you now need to enter the access data for your VoIP account. You will receive all the necessary data from your VoIP provider. This will include:

Either:

- ◆ Your user name (if required by the VoIP provider).
This is the user name of your IP account (caller ID), frequently identical to your phone number.
- ◆ Your authentication name or user ID
- ◆ The (login) password registered with the VoIP provider
- ◆ General settings for your VoIP provider (server addresses etc.)

Or:

- ◆ An auto configuration code (activation code)

Your Gigaset phone's VoIP wizard can help you make these entries.

Please note

You can configure up to six VoIP connections. When you get started with the phone, you can initially only configure one VoIP connection. You can configure additional VoIP connections later with the VoIP wizard (→ **page 108**) or the Web configurator.

Starting the VoIP assistant

Prerequisite: The phone is connected to the router. The router is connected to the Internet (→ **page 20**).

- ▶ Press the right display key **Yes** to launch the VoIP wizard.



Information about the VoIP wizard appears in the display.

- ▶ Press the bottom of the control key  to scroll down.
- ▶ Press the **OK** display key to continue.



The configurable IP connections are shown in the following displays (**IP 1** to **IP 6**). VoIP connections that are already configured are marked with .

- ▶ If necessary, press down on the control key  to select a connection.
- ▶ Press the **OK** display key to continue.

You will see the following display:



Your VoIP provider has supplied you with an **authentication name/password** and, where applicable, a user name:

- ▶ Press the key below **No** on the display screen.
- ▶ For further information, please see "**Downloading VoIP provider data**" → **page 27**.

You have received an **auto configuration code** (activation code) from your VoIP provider:

- ▶ Press the key below **Yes** on the display screen.
- ▶ For further information, please see "**Entering the auto configuration code**" → **page 26**.

No Internet connection:

The phone requires an Internet connection for you to register your telephone with a VoIP provider. If a connection cannot be made, one of the following messages is displayed:

- ◆ If the phone cannot establish a connection to the router, the message **IP address not available** is displayed.

Check the plug connection between the router and the base and check the settings on the router.

Your phone is preconfigured for dynamic assignment of the IP address. In order for your router to "recognise" the phone, dynamic IP address assignment must also be activated on the router, i.e., the router's DHCP server must be activated. If the DHCP server cannot or should not be activated, you must assign a fixed IP address to the phone (→ [page 106](#)).

- ◆ If the phone cannot establish a connection to the Internet, the message **Internet conn. not available** is displayed.

The IP server may be temporarily unavailable. In this case, try to make a connection again later.

Otherwise, check the plug connection between the router and the modem or DSL connection and check the settings on the router.

- ▶ Press **OK** to close the VoIP wizard.

You will then need to call up the wizard later via the menu to configure the IP connection.

Entering the auto configuration code



- ▶ Using the keypad, enter the auto configuration code you received from the provider (max. 32 characters).

If you enter an incorrect character, you can delete it by pressing the left display key.

- ▶ Press the key below **OK** on the display screen.

All data required for VoIP telephony is loaded directly from the Internet to your phone.

When all the data has been successfully loaded onto your phone, **IP account is registered** appears on the display.

- ▶ For further information, please see "[2. Connection wizard](#)", [page 30](#).

Downloading VoIP provider data

The connection wizard establishes a connection with the Gigaset configuration server on the Internet. Various profiles with general access data for different VoIP providers can be downloaded here.

After a brief period you will see the following display:



A list of countries is loaded.

- ▶ Press up or down on the control key  repeatedly until the country in which you want to use the phone and for which the telephone is permitted is selected in the display.
- ▶ Press the key below **OK** on the display screen to confirm your selection.



A list of the VoIP providers for which a profile with the general access data is available on the configuration server is loaded.

- ▶ Press up or down on the control key  repeatedly until your VoIP provider is shown in the display.
- ▶ Press the key below **OK** on the display screen to confirm your selection.

The general access data for your VoIP provider will be downloaded and saved on the phone.

You have not been able to download your provider's data

If your VoIP provider does not appear in the list, i.e., its general data is not provided for download, you must cancel the VoIP wizard:

- ▶ **Briefly** press the end call key  repeatedly until **End wizard?** appears in the display and then press the display key **Yes**.

You must then make the required VoIP provider and IP account settings using the Web configurator. You receive the general provider data from your VoIP provider.

You can change the assignment of the VoIP connection as send/receive connection at a later time via the Web configurator.

Entering user data for your VoIP account

You are now prompted to enter your personal access data for your VoIP account.

The following are provider-dependent:

- ◆ **User ID** (authentication name), **Password**, **User Name**

Please note ...

... when entering access data, it is case sensitive.

To switch between upper and lower case and digits, press the **#~** key (several times if necessary). You can see briefly in the display whether upper case, lower case or digit input is selected.

Characters entered incorrectly can be deleted using the left display key below **Del.**. The character to the left of the cursor is deleted.

You can navigate within the input field using the control key **↔** (left/right).



- ▶ Using the keypad, enter the user ID that you received from your VoIP provider.

- ▶ Press the key under **OK** on the display screen.



- ▶ Use the keypad to enter your password.

- ▶ Press the key under **OK** on the display screen.



- ▶ Using the keypad, enter the username that you received from your VoIP provider.
- ▶ Press the key under **OK** on the display screen.

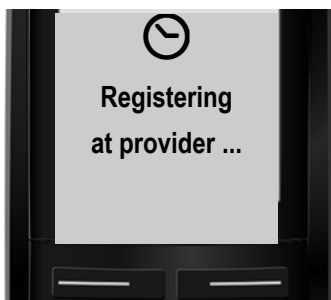

Once you have made all the necessary entries, the VoIP wizard will try to register the phone with the VoIP provider.

After successful registration, the message "IP account is registered" appears in the display.

The connection wizard starts.

2. Connection wizard

The connection wizard enables you to assign previously configured connections (fixed line connection, Gigaset.net and VoIP connections, → [page 48](#) and → [page 23](#)) to the registered handsets as receive and, if applicable, as send connections.

- ◆ **Receive connections** are the phone numbers (connections) on which you can be called. Incoming calls are only forwarded to the handsets for which the relevant connection is assigned as receive connection.
- ◆ **Send connections** are the connections that you use to conduct external calls. The network provider calculates charges based on the send connections. You can assign a connection to each handset as a send connection permanently.
- ◆ Each connection (number) of your phone can be both a send as well as a receive connection. You can assign each connection to several internal parties as a send and/or receive connection.

Default assignment

All configured connections are assigned to the handsets as receive connections and the fixed line connection as send connection at registration/start-up.

Launching the connection wizard

a.



- ▶ Press the display key **Yes** if you wish to change the setting for the send and receive connections of the **handset** with the internal name **INT 1**.
- ▶ Press the display key **No** if you do not wish to change the setting for this handset.

b.



The receive connections currently assigned to the handset are displayed.

You have to press down on the control key (⏴) to scroll through the list.

- ▶ Press the display key **Change** if you wish to change the receive connection setting.
- ▶ Press the display key **OK** if you do not wish to change assignment of the receive connections.

If you press **OK**, proceed to → **e.**

Press **Change** to display the following:

c.

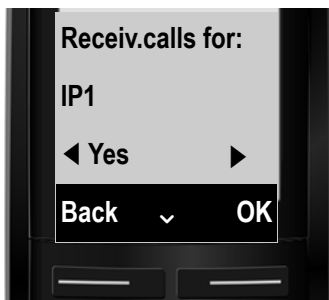



If no calls to the VoIP connection **IP1** are to be signalled on the handset:

- ▶ Press **right** (or left) on the control key  to set to **No**.

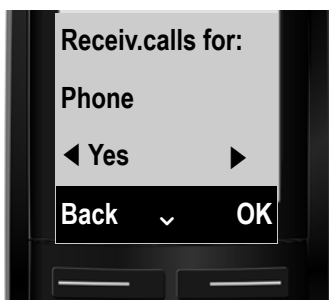

d.



- ▶ Press **down** on the control key  to switch to the next connection. Select either **Yes** or **No** as described above.
- ▶ Repeat the steps for each connection.

- ▶ Press the display key **OK** once you have finished configuring the settings for the handset.

The updated list of receive connections is displayed one more time for you to check.

Press the display key **OK** to confirm the assignment.

e.



The send connection currently set for the handset is displayed: **Phone**.

- ▶ Press the display key **OK** if you do not wish to change the setting. Skip the following step.
- ▶ To change the setting, press the display key **Change**.

f.





If the handset is to make calls via a different connection/phone number:

- ▶ Press **right** on the control key  repeatedly, until the required connection is displayed (in the example, **IP1**).



- ▶ Press the display key **OK** to save the settings.

The connection selected here is used as the standard send connection on this handset if you briefly press the talk key  after entering the number.

You always have the option of selecting another connection to set up a call. If you press and **hold** the talk key , a list with all available connections is displayed for selection (→ [page 43](#)).

Instead of a specific standard send connection, you can also assign **Select at each call** to the handset. Each time you make a call, you then have to select the connection you wish to use on this handset (→ [page 44](#)).

If other handsets are already registered to the base, you are requested to assign send and receive connections for the handsets. The following is shown in the display:

Assign connect. to INT1?

- ▶ Perform steps **a.** to **f.** for each registered handset.

After successfully configuring the settings, you will briefly see the following display:



Completing the installation

If you have started the wizard using the message key , the handset switches to idle status (an example for the display in idle status):

Screen display

◆ Reception between the base and the handset:

- Good to poor:
- No reception:

If **Eco Mode+** ([page 91](#)) is activated, is displayed.

◆ Charge status of the batteries:

- Charged over 66%
- Charged between 34% and 66%
- Charged between 11% and 33%
- Charged below 11%
- Flashes: battery almost empty (less than 10 minutes talktime)
- Illuminated: batteries charging

◆ INT 1

Internal name of the handset ([page 98](#))

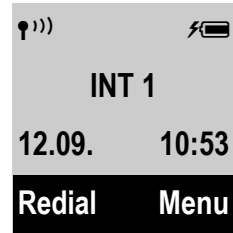

Please note

To protect your phone and its system settings from unauthorised access, you can define a 4-digit number code (system PIN) known only to yourself. This code must be entered before you can register/de-register handsets or alter your phone's VoIP or LAN settings.

The default system PIN is 0000 (4 x zero).

For instructions on changing the PIN → [page 106](#).

Date/time

There are two methods of setting the date and time:

- ◆ By default, your phone is configured so that the date and time are transferred from a time server on the Internet, provided it is connected to the Internet. You can activate/deactivate the synchronisation with a time server via the Web configurator (→ [page 136](#)).
- ◆ You can also set the date and time manually via the menu of one of the registered handsets (→ [page 105](#)).

To ensure you have the correct time, for example, for incoming calls, in the call lists and other lists and to use the alarm clock, the date and time must be set.

Proceeding

Now you have successfully set up your phone, you'll want to adapt it to your personal requirements. Use the following guide to quickly locate the most important subjects.

If you are unfamiliar with menu-driven devices such as other Gigaset telephones, read the section entitled "**Using the phone**" → **page 35** first.

Information on is located here.
Making external calls and accepting calls	▶ page 43
Setting the ringtone melody and volume	▶ page 102
Setting Eco Mode	▶ page 91
Preparing the telephone for SMS reception	▶ page 74
Registering available Gigaset handsets to the base and transferring their directory entries to the new handset	▶ page 94 ▶ page 63
Using online directories	▶ page 64
Entering additional VoIP accounts	▶ page 108
Operating the telephone on a PABX	▶ page 113
Configuring the phone via the Web configurator	▶ page 116

Using the phone





Control key

In the description below, the side of the control key (up, down, right, left) that you have to press in the different operating situations is marked in black e.g.,  for "press right on the control key".



The control key has a number of different functions:







When the handset is in idle status

-  Open the main menu.
-  Press **briefly** to open the handset directory.
Press and **hold** to open the list of available online directories.
-  Open the list of handsets.
-  Call up the menu for setting the handset's call volume (→ [page 101](#)).





In menus and lists

- / Scroll up/down line by line.





In input fields

You can use the control key to move the cursor up , down , right  or left .

During an external call

-  Mute the microphone.
-  Open the directory.
-  Initiate an internal consultation call.
-  Adjust the loudspeaker volume for earpiece and handsfree mode.

Keys on the keypad

- // etc.
Press the corresponding key on the handset.
-  Enter digits or letters.

Correcting incorrect entries

You can correct incorrect characters in the input fields by navigating to the incorrect entry using the control key. You can then:

- ◆ Delete the **character** to the left of the cursor with the display key **Del.** (press and **hold** to delete the **word**)
- ◆ Insert characters at the cursor position
- ◆ Overwrite the highlighted (flashing) character, e.g., when entering time and date

Menu guidance

Your telephone's functions are accessed via a menu consisting of several levels (menu overview → [page 40](#)).



Main menu (first menu level)

- ▶ With the handset in idle status, press the display key **Menu** or right on the control key  to open the main menu.

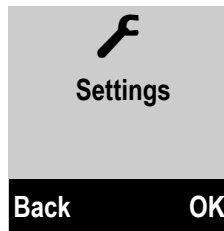
The functions in the main menu are displayed in the form of a list with names and icons (example on the right).



Selecting a function

- ▶ You can scroll between functions using the control key . The selectable function is shown in the display.
- ▶ Press the display key **OK** or right on the control key  to select the displayed function. This opens the corresponding submenu and the first entry is displayed.

If you press the display key **Back** or **briefly** press the end call key , the display returns to idle status.

Submenus

The functions in the submenu are displayed with the corresponding names.

Selecting a function

- ▶ You can scroll between functions using the control key . The relevant function is shown in the display.
- ▶ Press the display key **OK** to select the displayed function. This opens the corresponding submenu and the first entry is displayed.

Briefly press the display key **Back** or the end call key  to return to the previous menu level or cancel the operation.

Any settings you have not confirmed by pressing **OK** will be discarded.

Returning to idle status

From any point in the menu:

- ▶ Press and **hold** the end call key  or
- ▶ Do not press any key: after 2 minutes, the display will **automatically** revert to idle status.

An example of the display in idle status is shown on [page 33](#).

Activating/deactivating the handset



With the phone in idle status, press and **hold** the end call key (confirmation tone) to deactivate the handset.
Press and **hold** the end call key again to reactivate the handset.

Activating/deactivating the keypad lock

The keypad lock prevents any inadvertent use of the phone.



Press and **hold** the hash key in idle status to activate or deactivate the keypad lock. You will hear the confirmation tone.

If the keypad lock is activated, you will see a message when you press a key.

The keypad lock deactivates automatically when you receive a call. It is reactivated when the call is finished.

Please note

When the key lock is active, you cannot call emergency numbers.

Understanding the operating steps

The operating steps are shown in abbreviated form, for example:

Menu ▶ **Settings** ▶ **Eco Mode+** (☑ = on)

▶ This means you should proceed as follows:

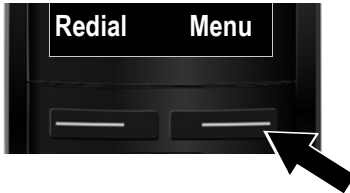

▶ Press the key below **Menu** on the display screen to open the main menu.



▶ Press down on the control key ☐ ...



... until the **Settings** menu item appears.

▶ Press the key below **OK** on the display screen to confirm your selection.



▶ Press down on the control key ☐ ...



... until the **Eco Mode+** menu item appears.

- ▶ Press the key below **OK** on the display screen to switch the function on or off (☑ = on).

- ▶ Press the key below **Back** on the display screen to jump back to the previous menu level.

or

Press and **hold** the end call key  to return to idle status.

Menu tree

The menu entries are divided into sections. The page numbers refer to the relevant description in the user guide.

To open the main menu: press the **Menu** display key when the phone is in idle mode.

✉ SMS

Write Message
Incoming
Outgoing
Settings

Service Centres
Notification
Status Report

- [page 74](#)
- [page 78](#)
- [page 75](#)
- [page 80](#)
- [page 80](#)
- [page 75](#)

📞 Select Services

Withhold No. Next Call
Call Divert
Call Waiting
Withhold No. All Calls
Transfer (ECT)

Int
Phone
IP1
IP2
:
IP6

The VoIP connections configured on the phone are displayed.

- [page 54](#)
- [page 53](#)
- [page 51](#)
- [page 56](#)

📖 Online Contacts

Gigaset.net
Online Directory
Yellow Pages
Prv.NetDir

- [page 70](#)
- [page 64](#)
- [page 64](#)
- [page 68](#)

🕒 Alarm Clock

Activation
Wake up time

- [page 93](#)
- [page 93](#)

Voice Mail

Play Messages	Net AM Fixed Line	→ page 90
	Net AM IP1	→ page 88
	:	
	Net AM IP6	
Network Mailboxes	Net AM Fixed Line	→ page 88
	Net AM IP1	
	:	
	Net AM IP6	
Set Key 1	Net AM Fixed Line	→ page 89
	Net AM IP1	
	:	
	Net AM IP6	

Settings

Date/Time		→ page 105
Audio Settings	Call Volume	→ page 101
	Ringer Volume	→ page 102
	Advisory Tones	→ page 104
	Battery Low	→ page 104
	Ringtones (Handset)	→ page 102
Display	Screensaver	→ page 99
	Colour Schemes	→ page 100
	Contrast	→ page 100
Language		→ page 99
Registration	Register Handset	→ page 94
	De-register Handset	→ page 95
Telephony	Auto Answer	→ page 101
	VoIP Wizard	→ page 108
	Calls List Type	→ page 59
	Recall	→ page 113
	Access Code	→ page 113
	Music on hold	→ page 106

Menu tree

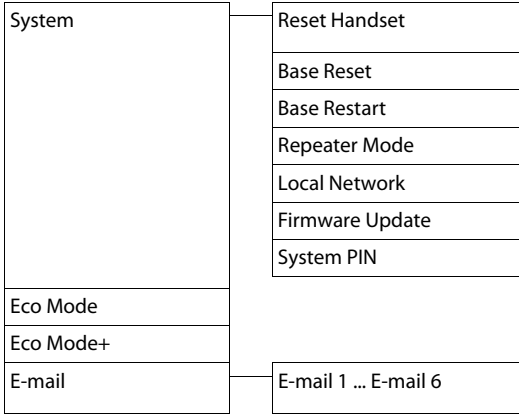

→ [page 104](#)

→ [page 111](#)

→ [page 111](#)

→ [page 110](#)

→ [page 106](#)

→ [page 109](#)

→ [page 106](#)

→ [page 91](#)

→ [page 91](#)

→ [page 84](#)

Making calls

Please note

You can conduct up to three external calls on your base in parallel — two via VoIP and one via the fixed line.

Making an external call

External calls are calls made via the public telephone network (fixed line) or via the Internet (VoIP).

To make an external call, you have to select one of the phone connections as a send connection. You have the following options:

- ◆ Assign a connection to the handset as a send connection permanently.
- ◆ As standard, you can select a send connection each time you make a call. Press and hold the talk key  to open a list with all available send connections for the phone.

Permanently assigned send connection

Prerequisite:

A specific connection (fixed line or VoIP connection) is assigned to the handset as a send connection.



Enter the number and **briefly** press the talk key. If there is no dialling plan for the selected number (→ [page 132](#)), the number is dialled via the send connection of the handset. If there is a dialling plan, the number is dialled via the connection defined in the dialling plan. If the phone number is blocked by a dialling plan, it will not be dialled. **Not possible!** is displayed.

Or:



Enter the number and press and **hold** the talk key. The list of your phone's connections is displayed.



Select a line.

Dial

Press the display key. The number is dialled immediately.

Or:



Press and **hold** the talk key and select the connection.

Dial

Press the display key.



Enter the number. The number is dialled approximately 3.5 seconds after the last digit is entered.

The dialled numbers and the send connection used are shown in the display (e.g., **via IP2**). The connection name you have assigned is displayed where available. Otherwise, the standard name is used.

After a VoIP connection has been set up, the number of the VoIP connection used is shown in the top right of the display (for IP2 02).

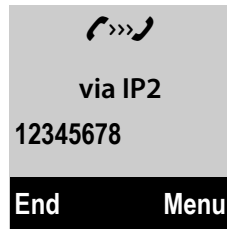

Please note

- ◆ If you use VoIP to make a call to the fixed line, you may also have to dial the area code for local calls (depending on the provider). You can avoid having to dial your own area code by entering it in the configuration and activating the **Predial area code for local calls via VoIP** option (see Web configurator).
- ◆ If you have activated the **Automatic Fallback to Fixed Line** option with the Web configurator and the attempt to connection via VoIP fails, the system automatically tries to set up the connection via the fixed line.
- ◆ Gigaset.net numbers ending with the suffix #9 are automatically dialled via the Gigaset.net connection. The calls are free of charge (→ [page 48](#)).

Selecting a line for each call

Prerequisite: The "Select at each call" option has been assigned to the handset instead of a send connection.



Enter the number and press the talk key. The list of all the phone's connections is displayed.



Select a line.



Press the display key.

If a dialling plan has been defined for the dialled phone number (→ [page 132](#)), then the send connection specified in the dialling plan is used.

Please note

- ◆ You can cancel the dialling process with the end call key .
- ◆ You are shown the duration of the call while the call is in progress.
- ◆ Dialling with the directory ([page 61](#)) or call and redial list ([page 57](#)) saves you from repeatedly keying in phone numbers.

Using the connection list on the display key

Prerequisite: You have assigned the list with all configured connections to a display key (→ [page 100](#)).



Press the display key and select the connection.



Press the talk key or display key.



Enter a number. The number is dialled approximately 3.5 seconds after the last digit is entered.

Any dialling plan that has been defined for the dialled phone number is ignored. Exception: If a block is set in the dialling plan, this takes effect for VoIP connections (but not fixed line connections).

Calling an IP address (provider-dependent)

You can also dial an IP address instead of a phone number using VoIP.

- ▶ Press the star key **[*]** to separate the sections of the IP address (e.g., 149*246*122*28).
- ▶ If necessary, press the hash **[#]** key to attach the SIP port number of the person you are calling to the IP address (e.g., 149*246*122*28#5060).

If your VoIP provider does not support the dialling of IP addresses, each part of the address will be interpreted as a normal phone number.

Dialling emergency numbers

If no dialling plans for emergency numbers are preset on your telephone, you should set dialling plans yourself. Assign them to a connection that you know supports emergency numbers. Calls to emergency numbers are always supported by fixed lines.

Please note: If no dialling plans are defined for emergency numbers and you have programmed an automatic local area code, the code will also be prefixed to emergency numbers as soon as they are dialled via a VoIP connection.

Displaying the phone number you are calling (COLP)

Prerequisites:

- ◆ Your network provider supports COLP (**C**onnected **L**ine **I**dentification **P**resentation). You may need to activate COLP with the provider (ask your provider about this).
- ◆ The called party has not activated COLR (**C**onnected **L**ine **I**dentification **R**estriction).

For outgoing calls, the phone number of the connection on which the call is received is displayed on the handset.

The displayed number may differ from the number you have dialled. Examples:

- ◆ The called party has activated call divert.
- ◆ The call is answered by another connection within a PABX system.

If there is an entry in the directory for this phone number, the corresponding name will be displayed.

Please note

- ◆ The actual number of the connection you have reached (or the assigned name) is displayed instead of the called number during call swapping, conference calls and consultation calls.
- ◆ When the phone number is copied to the directory and the redial list, the dialled number (not the displayed number) is copied.

Ending a call



Press the end call key.

Accepting a call

An incoming call is indicated in three ways: By ringing, by a display on the screen and by the flashing speaker key .

Please note

Only calls to the receive connections assigned to the handset are signalled.



The following applies in particular if VoIP connections are configured on your base:

- ◆ If you have not explicitly assigned the receive connections on your phone, all incoming calls are signalled on all registered handsets. As standard all available connections are assigned to all handsets as receive connections.
- ◆ If you have performed an explicit assignment between handsets and receive connections but not assigned one connection to any handset as the receive connection, calls on this connection will not be signalled on any handset.
- ◆ If a call cannot be assigned to any connection on the phone, this call is signalled on all handsets (e.g., a connection established via an IP address).

You can answer the call by:

- ▶ Pressing the talk key .
- ▶ If the handset is in the charger and the **Auto Answer** function is activated (→ [page 101](#)), the handset automatically accepts the call when you remove it from the charger.
- ▶ For a call to the fixed line connection: press the **Accept** display key.

To deactivate the ringtone, press the **Silence** display key. You can accept the call as long as it is displayed on the screen.

If you press the end call key  or the **Reject** display key, a call to a VoIP connection is rejected. If you press the end call key  for a call to the fixed line connection, the ringtone is merely deactivated, as for **Silence**.

Calling line identification

When you receive a call, the caller's number is displayed on the screen if the following prerequisites are met.

- ◆ Your network provider supports CLIP, CLI.
 - CLI (Calling Line Identification): the caller's number is transmitted.
 - CLIP (Calling Line Identification Presentation): the caller's number is displayed.
- ◆ You have requested CLIP from your network provider.
- ◆ The caller has requested CLI from the network provider.

Call display

If the number of the caller is stored in your directory, the number is replaced by the corresponding directory entry.

You can use the display to see which receive connection the call is directed to.

Example of display:

Call to the fixed line connection

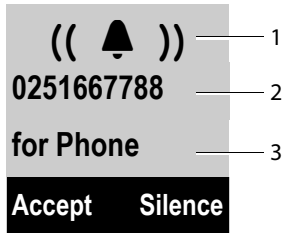

Call to a VoIP connection

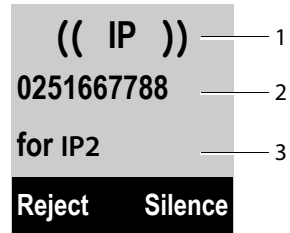

- 1 Ringtone icon (background colour changes for a VIP group assigned, → [page 62](#))
- 2 Number or name of caller
- 3 Receive connection: Indicates which of your phone numbers the caller has dialled. The name you set when configuring the phone or the default name is displayed (**Phone** or **IP1** to **IP6**).
"for Gigaset" is displayed for calls from Gigaset.net.

The following is displayed instead of the number:

- ◆ **External Call**, if no number is transmitted.
- ◆ **Withheld**, if the caller has withheld Calling Line Identification ([page 51](#)).
- ◆ **Unavailable**, if the caller has not arranged Calling Line Identification.

Notes on phone number display (CLIP)

By default, the number of the caller is shown in the display of your Gigaset telephone. You do not have to make any other settings on your Gigaset telephone.

However, if the caller's number is not displayed, this can be due to the following:

- ◆ You have not requested CLIP from your provider
- ◆ Your telephone is connected via a PABX or a router with an integrated PABX (gateway) that does not transmit all information.

Is your telephone connected via a PABX/gateway?

You can establish this by checking for an additional device connected between your telephone and home connection, e.g., a PABX, gateway etc. In most cases, simply resetting this device will remedy the situation:

- ▶ Briefly disconnect the PABX power plug. Re-insert the plug and wait for the device to restart.

If the caller number is still not displayed:

- ▶ Check the CLIP (phone number display) settings of your PABX and activate this function if necessary. In the user manual for the device, search for the term "CLIP" (or an alternative term such as "calling line identification", "phone number identification", "caller ID" etc.). If necessary, contact the device manufacturer.

If this does not resolve the problem, it is possible that your network provider does not provide the CLIP service for this number.

Have you requested the phone number display service from your network provider?

- ▶ Check whether your provider supports phone number display (CLIP) and that the function has been activated for you. If necessary, contact your provider.

Additional information on this subject can be found on the Gigaset website at: www.gigaset.com/service.

VoIP telephony via Gigaset.net

You can use **Gigaset.net** to make free phone calls via the Internet **directly** to other Gigaset.net users (e.g., other persons, friends and family members who have a Gigaset IP phone) without having to set up an account with a VoIP provider or make any further settings. You simply have to connect your phone to the power supply and the Internet connection and, if necessary, enter yourself in the Gigaset.net online directory under a name of your choice (→ [page 72](#)).

Gigaset.net is a VoIP service provided by Gigaset Communications GmbH to which all users of a Gigaset VoIP device can subscribe.

You can call other subscribers to Gigaset.net **free of charge** i.e., there are no telephone charges other than the costs for your Internet connection. Connections to/from other networks are not possible.

Numbers ending with the suffix #9 are automatically dialled via the Gigaset.net connection.

Please note

Gigaset.net supports broadband telephony: Gigaset.net calls that you make from your phone with a different broadband-capable terminal have brilliant sound quality (e.g., High Definition Sound Performance, → [page 49](#)).

Every Gigaset VoIP device is assigned a Gigaset.net phone number by default (→ [page 152](#)).

All registered subscribers are included in the Gigaset.net directory, which you are able to access.

An echo service is available for you to check your VoIP connection.

The echo service is available in six languages:

- ◆ 12341#9 (English)
- ◆ 12342#9 (Dutch)
- ◆ 12343#9 (Italian)
- ◆ 12344#9 (French)

- ◆ 12345#9 (German)
- ◆ 12346#9 (Spanish)

After an announcement, the echo service immediately sends back the voice data you have received in the form of an echo.

Exclusion of liability

Gigaset.net is a voluntary service provided by Gigaset Communications GmbH with no liability or guarantee for the availability of the network and the performance.

Please note

If you do not use your Gigaset.net connection for six months, it is automatically disabled. You cannot be reached for calls from Gigaset.net.

The connection is reactivated:

- ◆ As soon as you start a search in the Gigaset.net directory (→ [page 72](#)) or
- ◆ Make a call via Gigaset.net (dial a number with #9 at the end) or
- ◆ Activate the connection via the Web configurator

Gigaset HDSP – telephony with brilliant sound quality



Your Gigaset telephone supports the broadband codec G.722. You can therefore use it to make calls with brilliant sound quality (High Definition Sound Performance) via VoIP.

If you register broadband-capable handsets with your base, internal calls between these handsets will also be made via broadband.

The following are prerequisites for broadband connections on your telephone:

◆ For internal calls:

The handsets involved are broadband-capable, i.e., they support codec G.722.

◆ For external calls via VoIP:

- You make the call from a broadband-capable handset.
- You have selected codec G.722 for outgoing calls.
- Your VoIP provider supports broadband connections.
- The recipient's phone supports codec G.722 and accepts the establishment of a broadband connection.

Please note

The VoIP service **Gigaset.net** (→ [page 48](#)) supports broadband connections.

Activating/deactivating handsfree mode

In handsfree mode, instead of holding the handset to your ear you can put it down, for example on the table in front of you. For example, this allows others to participate in the call.

Please note

Inform your caller before you use handsfree mode so that they know a third party may be listening.

During a call, activate or deactivate handsfree mode:



Press the handsfree key.

Each key press switches between earpiece and handsfree mode. If handsfree mode is activated, the key is lit up.

If you wish to place the handset in the charger during a call:

- ▶ Press and hold the handsfree key  while placing the handset in the base/charger and for a further 2 seconds.

For instructions on adjusting the loudspeaker volume, see → [page 101](#).

Muting the handset

You can deactivate the handset's microphone during an external call (including during a conference or when call swapping). The other parties cannot hear you, but you can still hear the other party.

Prerequisite: you are conducting an external call.





Press **right** on the control key to mute the handset. The display shows **Microphone is switched off**.

Press the  key again to unmute the microphone.

If a second call (call waiting) is received in mute mode, this is signalled acoustically as usual. However, it is only shown on the display once the microphone has been unmuted.

Please note

In mute mode, all keys on the handset are deactivated with the exception of the:

- ◆ The right side of the control key (unmute microphone)
- ◆ End call key , that you can use to end the call
- ◆ Talk key , that you can use to activate/deactivate handsfree mode

Making calls using select services

Select services are functions that your network provider makes available to you.

Please note:

- ◆ The **Select Services** menu cannot be open on two handsets simultaneously. If this is the case, you will hear a negative acknowledge tone.
- ◆ Some select services may only be used if you have requested them from your fixed line provider (there may be an extra charge).
- ▶ **If you require assistance, please contact your network provider.**

Configuring general settings for all calls

Anonymous calling – withholding caller ID (CLIR)

You can make anonymous calls (CLIR = Calling Line Identification Restriction). Your phone number will not be displayed when you make outgoing calls. You are calling anonymously.

Prerequisites:

- ◆ For anonymous calls via your fixed line connection, you need to have requested the relevant service (feature) from your network provider.
- ◆ Anonymous calls are only possible via VoIP connections through providers that support the "anonymous calling" function. You may have to ask your VoIP provider to activate this function.

Activating/deactivating "anonymous calling" for all calls permanently

When this function is activated, the phone number is withheld for all fixed line calls and for all calls via VoIP connections. Anonymous calling is activated for all registered handsets.

Menu ▶  **Select Services** ▶ **Withhold No. All Calls**
Select and press **OK** (= on).

For instructions on withholding your number temporarily for the next call see → [page 54](#).

General call divert (CD)

A distinction is made between

- ◆ Diverting calls internally and
- ◆ Diverting calls to an external phone number

Diverting calls to an external connection

With call divert the call is diverted to another external connection. Your call divert settings can be specific to a particular connection, i.e., for every connection (fixed line number and VoIP connection) that is assigned to the handset as a receive connection.

Prerequisite: The VoIP provider supports call divert.

Making calls using select services

Menu ▶ Select Services ▶ Call Divert

A list containing the configured and activated receive connections for your phone and **Int** is displayed.

- ▶ Select the receive connection for which you want to activate or deactivate call divert, and press **OK**.
- ▶ You can enter data in the following fields:

Status

Press right/left on the control key to activate/deactivate call divert.

Phone number

Enter the number to which the call is to be diverted. You can specify a different fixed line, VoIP or mobile number for every connection.

When

Select **All Calls/No Answer/When Busy**.

All Calls: Calls are diverted immediately i.e., no more calls to this connection are signalled on your phone.

No Answer: Calls are diverted if no one accepts the call within several rings (VoIP only).

When Busy: Calls are diverted when your line is busy (VoIP only).

Send Press the display key.

For diverting calls from the fixed line:

A connection is established to the telephone network to activate/deactivate call divert.

- ▶ After confirmation from the fixed line, press the end call key .

Please note

Diverting calls to your phone numbers can result in **additional costs**. Please consult your provider.

Diverting calls internally

You can divert the signalling of all incoming **external** calls for your handset to another handset.

Menu ▶ Select Services ▶ Call Divert

Int Select and press **OK**.

- ▶ You can enter data in the following fields:

Status

Press right/left on the control key to activate/deactivate call divert.

To handset

Press right/left on the control key to select the target handset.

No HS is displayed if internal call divert has not been set previously or if the previously set handset is no longer registered.

Ring delay

If you prefer to have a delay before the call is diverted, select the length of the delay at this point (**None**, **10 sec.**, **20 sec.** or **30 sec.**). If you select **None**, the call is not signalled on the handset and is diverted immediately.

OK Press the display key.

Internal call divert is only single-stage i.e., if calls for the handset are diverted to a different handset (e.g., MT1) on which a call divert is also active (e.g., to MT2), this second call divert is not executed. The calls are signalled on handset MT1.

Please note

- ◆ Any call for the handset that has been diverted is entered in the call lists.
- ◆ If a call to a receive connection that is only assigned to the handset is diverted to a handset that is not available (e.g., the handset is deactivated), the call is rejected after a short time.

Activating/deactivating call waiting for external calls

If the function is activated, during an **external** call you will hear a call waiting tone to signal that another external caller is trying to get through. If you have CLIP, the number of the waiting caller or the corresponding directory entry is shown in the display. The caller will hear the ringing tone.

When call waiting is deactivated, the caller will hear the busy tone if you are already making a call and you are the only party assigned to this connection.

Activating/deactivating call waiting

Prerequisite for calls via VoIP: Parallel VoIP connections are permitted on your telephone (default setting; setting can be changed via the Web configurator).

Menu ▶  **Select Services** ▶ **Call Waiting**



Select **On/Off** to activate/deactivate call waiting.

▶ Press the display key **Send**.

Call waiting is activated/deactivated for all connections to the telephone and all registered handsets.

To activate/deactivate the function for the fixed line connection, the phone establishes a connection to the exchange to send the relevant code.

▶ After confirmation from the fixed line, press the end call key .

Activating/deactivating call transfer – ECT (Explicit Call Transfer – VoIP)

If the function is activated, you can connect two external callers on a VoIP connection with each other by pressing the end call key  (→ [page 55](#)). This assumes that you are making an external call via one of your VoIP connections and start an external consultation call.

You can activate/deactivate this function via your handset.

Menu ▶  **Select Services**

Transfer (ECT)

Select and press **OK** ( = on).

Please note

You can use the Web configurator to change further settings for the call transfer on a VoIP connection (→ [page 135](#)).

Configuring settings for the next call

Activating "anonymous calling" for the next call (VoIP)

You can withhold your phone number for the next call (CLIR = Calling Line Identification Restriction). The setting applies to all the phone's connections.

In idle status:

Menu ▶  **Select Services** ▶ **Withhold No. Next Call**
Select and press **OK**.

 Enter the number or copy from the directory.

Dial Press the display key. The number is dialed.

Generally speaking, you can withhold your number for all calls → [page 51](#).

Actions during an external call

Please note

For VoIP telephony, the services described below are only available if parallel IP connections are permitted.

Accepting a waiting call (VoIP)

You are making an external call and hear the call waiting tone.

With Calling Line Identification:

Accept Press the display key.

Without Calling Line Identification (fixed line):

Menu ▶ **Accept Call Waiting**

Once you have accepted the waiting call, you can switch between the two callers ("**Call swapping (VoIP)**" → [page 55](#)) or speak to both at the same time ("**Conference calling**" → [page 56](#)).

Please note

- ◆ Without CLIP, a waiting call is only announced with a signal tone.
- ◆ An internal waiting call is shown on the display. You can neither accept the internal call nor reject it.
- ◆ For instructions on accepting a waiting external call during an internal call → [page 97](#).



Rejecting a waiting call (VoIP)

You can hear the call waiting tone but do not want to speak to the caller.

Reject Press the display key.

The waiting caller hears the busy tone.

Please note

You can also press the end call key  to end the current call, and then press the talk key  again to accept the second call.

Consulting an external call

You can call a second external caller. The first call is placed on hold.

During an external call:

ExtCall Press the display key.

The previous call is placed on hold. The caller hears an announcement or music on hold.



Enter the second participant's telephone number.

The phone number is dialled. You are connected to the second participant.

If the participant does not answer or you want to end the call to the second participant, press the **End** display key to switch back to the first participant.

The consultation call is established via the same send connection as the first call.

Please note

You can also select the second participant's phone number from the directory, redial list or a call list on the handset.

Ending a consultation call (VoIP)

Menu ▶ **End Active Call**

You are reconnected to the first call participant.

You can also end a consultation call by pressing the end call key . The connection is briefly interrupted and you will receive a recall. As soon as the call is accepted, you are reconnected to the first call participant. Prerequisite for VoIP connections:

Transfer Call by On-Hook is not activated ("ECT" → [page 53](#) and "**Configuring call transfer via VoIP**" → [page 135](#)).

Call swapping (VoIP)

You can speak to two callers one at a time (call swap).

Prerequisite: You are conducting an external call and have called a second participant (consultation call) or have accepted a waiting call.

▶ Use  to swap between the participants.

The caller you are currently speaking to is marked with the > icon.

Ending a currently active call

Menu ▶ **End Active Call**

You are re-connected to the waiting caller.

Conference calling

You can speak to two participants simultaneously.

Prerequisite: You are conducting an external call and have called a second participant (internal or external consultation call) or have accepted a waiting external call.

▶ Press the display key **Conf.**

You and the two other callers (both marked by the > icon) can hear and speak to each other simultaneously.

Ending a conference (VoIP)

▶ Press the display key **EndCon**.

You return to "call swap" status. You are reconnected to the caller with whom you started the conference.

Or:

 Press the end call key to end the call with both participants.

Each of the callers can end their participation in the conference call by pressing the end call key and terminating the call.

Transferring calls

Transferring a call to an internal party

You are making an **external** call and would like to transfer it to another handset.

▶ Set up an **internal** consultation call (→ **page 55**).

 Press the end call key (even before the other party has answered) to transfer the call.

Transferring a call to an external number (VoIP) – ECT (Explicit Call Transfer)

You are making an **external** call via a VoIP connection and wish to transfer the call to another external party.

Prerequisite: The feature is supported by the relevant network provider.

If you have activated the **Transfer Call by On-Hook** function for VoIP using the Web configurator ("**Configuring call transfer via VoIP**" → **page 135**).

 Press the end call key (even before the other party has answered) to transfer the call.

Using lists





The options are:

- ◆ Redial list
- ◆ Incoming message list
- ◆ Call lists
- ◆ Network mailbox





Redial list

The redial list contains the ten numbers last dialled with the handset (max. 32 numbers). If one of the numbers is in the directory, the corresponding name will be displayed.

Manual redial

-  Press the talk key **briefly**
or
- Redial**  Press the display key.
-  Select entry.
-  Press the talk key. The number is dialled.

Managing entries in the redial list

-  Press the talk key **briefly**
or
- Redial**  Press the display key.
-  Select entry.
- Menu**  Open menu.

The following functions can be selected with :

Use Number

(As in the directory, → [page 62](#))

Copy to Directory (→ [Storing a number in the directory, page 61](#))

Delete Entry

Delete selected entry.

Delete List

Delete **all** entries in the redial list.

Function of the message key



Opening lists

Use the message key  to open the following lists:

- ◆ Network mailbox, if your network provider supports this function and fast access is set for the network mailbox (→ [page 89](#)).
- ◆ Incoming message list (→ [page 78](#))
- ◆ E-mail lists (→ [page 85](#))
- ◆ Call list

An advisory tone sounds as soon as a **new entry** arrives in a list.

Depending on the type of the new entry, an icon appears in the display while in **idle status**:

Icon	New message ...
	... on the network mailbox
	... in the missed calls list
	... in the SMS list or an e-mail list

The number of **new** entries is displayed under the corresponding icon.



Please note

If calls are saved on the network mailbox, you will receive a message if the list type has been set accordingly (see your network provider user guide).

After pressing the message key , you can see all lists containing messages and the network mailbox list.

The list is displayed with the number of new entries (1) and the number of old, read entries (2). For the call list, the second number is the total number of old calls in all lists (example):

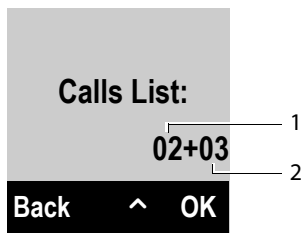

Select a list with . To open, press **OK**.

Activating/deactivating flashing message key

With the Web configuration, you can set the type of new messages for which the message key  should flash.

SMS inbox

All received SMS messages are saved in the incoming message list → [page 78](#).

Call list

Prerequisite: Calling Line Identification Presentation (CLIP, [page 46](#))

In the call list, the base saves entries for:

- ◆ Accepted calls
- ◆ Missed calls
- ◆ Outgoing calls

The lists of accepted and missed calls contains the last 30 entries for each. The list of outgoing calls contains the last 60 entries.

On your handset, you can also display the list of missed calls or all calls, divided into four individual lists.

Setting the call list type

Menu ▶ **Settings** ▶ **Telephony** ▶ **Calls List Type**

Missed Calls / All Calls

Select and press **OK** (= on).



Press and **hold** (idle status).

The call list entries are retained when you change the list type.

Opening the call list

In idle status, you can open the call list by pressing the message key .

For list type **Missed Calls**:

 ▶ **Missed Calls**

For list type **All Calls**:

 ▶ **Calls List** ▶ **All Calls / Outgoing Calls / Accepted Calls / Missed Calls**

List entry

Example of list entries:

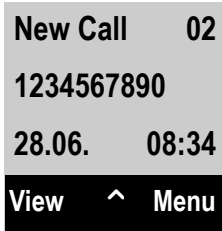

- ◆ Status of entry
 - **New Call:** New missed call
 - **Old Call:** Entry already read
 - **Call recv.:** Call was answered
 - **Outgoing:** Outgoing calls
- ◆ Entry number
- ◆ Number or name of caller
- ◆ Call date and time (if set, → [page 33](#)).
- ▶ Press the talk key  to call the selected caller back.
- ▶ If you press the **View** display key, further information is displayed for the entry, e.g., for missed calls the receive connection on which the call was received.
- ▶ Use the **Menu** display key to select the following options:
 - Copy to Directory**
(→ [Storing a number in the directory, page 61](#))
 - SMS Enquiry**
Send the number of the entry to SMS information to determine the name of the caller.
 - Delete Entry**
Delete selected entry.
 - Delete List**
Delete all entries in the list.

After exiting the call lists, all viewed entries are assigned the status "old".

Using directories

The options are:

- ◆ Your local handset directory
- ◆ Public net directory and Yellow Pages (→ [page 64](#))
- ◆ Gigaset.net directory (→ [page 70](#))
- ◆ Private net directory

Local directory

You can save a total of 150 entries in the directory.

You can create a personalised directory for your own individual handset. You can also send lists/entries to other handsets ([page 63](#)).

Please note

- ◆ The directory already contains entries for the Gigaset.net directory and the configured online directories.
- ◆ To quickly access a number from the directory (shortcut), you can assign the number to a key (→ [Using shortcut keys, page 63](#)).

In the **directory**, you can save

- ◆ Numbers and corresponding names
- ◆ VIP ringtones and colours.

Open the directory in idle status or during an external call with the  key.

Length of the entries

Number: max. 32 digits
Name: max. 16 characters

Storing a number in the directory

 ▶ **Menu** ▶ **New Entry**

 Enter the number and press **OK**.

 Enter the name and press **OK**.

Order of directory entries

Directory entries are generally sorted alphabetically by surname. Spaces and digits take first priority.

The sort order is as follows:



- 1 Space
- 2 Digits (0–9)
- 3 Letters (alphabetical)
- 4 Other characters

To work round the alphabetical order of entries, insert a space or a digit before the first letter of the name. These entries will then move to the beginning of the directory.



Selecting directory entries

 Open the directory.

You have the following options:

- ◆ Use  to scroll through the entries until the required name is selected.
- ◆ Enter the first character of the name, if necessary scroll to the entry with the  key.

Dialling with the directory

 ▶  (Select entry)

 Press the talk key.

Or during a call:

OK Press the display key.

Managing directory entries

 ▶  (Select entry)

Menu Press the display key.

The following functions can be selected with :

VIP CallerMelody

Mark a directory entry as a VIP (Very Important Person) by assigning a specific ringtone to it. The entry is flagged with the  icon in the directory. You recognise VIP calls by the ringtone.

VIP Caller Colour

Mark a directory entry as a VIP (Very Important Person) by assigning a specific background colour to it. The entry is displayed with this background colour in the address book and marked with the  icon. VIP calls are then recognised by their background colour.

Edit Entry

Edit the number if required and press **OK**.

Edit the name if required and press **OK**.

Use Number

Edit or add to a saved number and then use  to dial the number or save the number as a new entry;

To do so, display the number and press:

Menu ▶ **Copy to Directory** ▶ **OK**

Please note

When dialling, you can use this function to link several numbers from the directory (e.g., a call-by-call number to a telephone number,).

Delete Entry

Delete selected entry.

Send Entry

Send a single entry to a handset (→ **Transferring the directory to another handset, page 63**).

Delete List

Delete **all** directory entries.

Send List



Send the entire directory to a handset (→ **Transferring the directory to another handset, page 63**).

Shortcut

Assign the current entry as a shortcut to a selected key (→ **Using shortcut keys, page 63**).

Using shortcut keys

You can assign directory entries to the keys $[0-9]$ and $[2-9]_{\text{ABC}}-[9_{\text{WXYZ}}]$:

 ▶  (select entry) ▶ **Menu** ▶ **Shortcut** ▶  (press the key you want to assign the number to)



To dial, press and **hold** the relevant shortcut key.

Transferring the directory to another handset

You can transfer directory entries from other handsets to your new handset — even entries from old handsets.

Prerequisites:

- ◆ The sending and receiving handsets must both be registered to the same base.
- ◆ The other handset and the base can send and receive directory entries.

 ▶  (Select entry) ▶ **Menu** (Open menu)

Send Entry / Send List

Select and press **OK**.

 Select the internal number of the receiving handset and press **OK**.

You can transfer several individual entries one after the other by responding to the **Entry copied. Next entry?** prompt with **OK**.

A message appears on the display to confirm a successful transfer. You will hear the confirmation tone.

Please note:

- ◆ Entries with identical numbers are not overwritten on the receiving handset.
- ◆ The transfer is cancelled if the phone rings or if the memory of the receiving handset is full.
- ◆ VIP melodies and colours assigned to entries are not transferred.

Receiving a directory/directory entries from a handset

Prerequisite: The handset is in idle status.

- ▶ Start the transfer of directory entries on the handset as described in the handset user guide.

Using directories

If the data has been transferred successfully, the display on your handset will indicate the number of entries received (so far).

Adding a displayed number to the directory

You can copy numbers displayed in a list, e.g., the call list or redial list, to the directory.

A number is displayed:

Menu ▶ **Copy to Directory**

▶ Complete the entry (→ **Storing a number in the directory, page 61**).

Copying a number from the directory

In some operating situations, you can open the directory to copy a number (e.g., during an external call or in pre-dialling mode). Your handset need not be in idle status.

 Open the directory.

 Select an entry and press **OK**.

Using online directories

You can use public online directories (online directories, e.g., "White Pages", and classified directories e.g., "Yellow Pages") depending on your provider.

You can configure the online directories you wish to use via the Web configurator.

Exclusion of liability

This service is country-specific. Gigaset Communications GmbH therefore assumes no guarantee or liability for the availability of this service. The service may be discontinued at any time.

Opening an net directory/Yellow Pages

Prerequisite: The handset is in idle status.

 Press and **hold**.

Or:

Menu ▶  **Online Contacts**

This opens the list of online directories. Provider-specific names appear in the display.

 Select a directory (net directory or Yellow Pages) from the list and press **OK**.

This establishes a connection to the net directory or the Yellow Pages.

If there is only one net directory available, a connection is immediately established if you press and **hold** down the control key .

Please note

You can also establish a connection to the net directory as follows:

- ▶ When the handset is idle, dial **1#91** and press the talk key .
- ▶ To establish a connection to the Yellow Pages, dial **2#91**.
- ▶ To establish a connection to the Gigaset.net directory, dial **1188#9**.

Calls to the net directory are always free of charge.

Searching for an entry

Prerequisite: You have opened the net directory/Yellow Pages.

- ▶ You can enter data in the following fields:

Surname: (Net directory) or

Category/name: (Yellow Pages)

Enter the name, part of a name or the category (max. 30 characters).

City: Enter the name of the city/location in which the party you are searching for lives (max. 30 characters).

Or:

Enter number: Enter the number (max. 30 characters).

- ▶ Press the display key **OK** to start the search.

You must make an entry in **Surname** or **Category/name** and in **City** or in **Enter number**. Searching by number is only possible if supported by the net directory you have selected.

Please note

General instructions for entering text on your handset are set out in the handset user manual.

A list of the cities/locations found is displayed if the search returns more than one result:



Select city.

If the name of a city/location is longer than one line, it is abbreviated.

Select **View** to view the complete name.

If no matching city is found: press **Change** to change the search criteria.

The entries for **Category/name** and **City** are copied and you can change them.



Press the display key to continue the search.

A corresponding message will appear on the display if no party is found to match the search criteria. You have the following options:

- ▶ Press the display key **New** to start a new search.

Or

- ▶ Press the display key **Change** to change the search criteria. The name and city/location are copied over and you can change them.

No hits are displayed if the list of hits is too large. A message to this effect is displayed.

- ▶ Press the display key **Refine** to start a more detailed search (→ [page 67](#)).

Or

- ▶ Depending on the provider, you can view the list if the number of hits is shown on the display. Press the display key **View**.



Search result (hit list)

The search result is shown as a list on the display. Examples:



1. 1/50: Consecutive number/total number of hits (only the consecutive number is displayed if the total number of hits >99).
2. Two lines containing the name, industry sector, phone number (shortened if necessary). If a fixed line number is not available, the mobile number (if available) is displayed.

You have the following options:

- ▶ You can scroll through the list with .
- ▶ Press the display key **View**. Displays the full details of the entry (name, category where applicable, address, telephone numbers). You can scroll through the entry with .

Use **Menu** to access the following options:

Refine Search

Refine search criteria and restrict hit list (→ [page 67](#)).

New Search

Start a new search.

Copy to Directory

Copy an entry to the local directory. If an entry contains several numbers, they are displayed in a selection list. A new entry is created for the selected number. The surname is transferred to the **Surname** field of the local directory.

Copy to Private NetDir.

Transfer the selected entry to the private net directory. The private directory and net directory must be provided by the same provider.

Depending on your provider, you can add a nickname to the entry in your private directory.

Calling subscribers

Prerequisite: A hit list is displayed.

- ▶ Select the entry and press the talk key .

If the entry only contains one phone number, this is the one that is dialed.

A list of numbers appears if there is more than one number.

- ▶ Using , select a number and press the **Dial** display key.

Starting a refined search

You can use the search options available in the refined search (first name and/or street) to limit the number of hits returned by a previous search.

Prerequisite: A search result is displayed (hit list with multiple entries or a message indicating too many hits).

Refine Press the display key.

Or

Menu ▶ **Refine Search**
Select and press **OK**.

The search criteria from the previous search are copied and entered in the corresponding fields.

Surname: (Net directory) or

Category/name: (Yellow Pages)

If necessary, change the name/category or extend the partial name.

City: Name of the city from the previous search is shown (cannot be changed).

Street: If necessary, change the name of the street (max. 30 characters).

First Name: (only in the net directory)

If necessary, enter the first name (max. 30 characters).

OK Start detailed search.

Using the private net directory

Some providers offer users the option of creating and managing a private net directory on the Internet.

The advantage of an net directory is that you can call up entries from any telephone or PC, e.g., from your VoIP phone in the office or your PC at a hotel.

You can use the private net directory on your handset.

Prerequisites:

- ◆ Create your private net directory using your PC's Web browser.
- ◆ Create and manage entries in the net directory via your PC's Web browser.
- ◆ Activate the net directory on your phone using the Web configurator. You must save the username and password in particular for accessing your personal net directory on the phone.

You can use the directory from every registered handset.

Opening the net directory

Prerequisite: The handset is in idle status.

 Press and **hold**.

Or:

Menu ▶  **Online Contacts**



This opens the list of (online) directories. The provider-specific name is displayed for the private net directory.

 Select the private net directory from the list and press **OK**.

Your private net directory is opened.

Please note

If there is no other net directory available apart from the private net directory:

- ▶  **Press** briefly. The private net directory opens.
- ▶  **Press and hold**. The handset's local directory opens.

The entries in the net directory are sorted alphabetically according to the first non-space field in the entry. This is generally the nickname or surname.

Selecting, viewing and managing entries in the net directory

Prerequisite:

The net directory is open (see above).

▶ Scroll with  to the required entry.

Or:

Enter the first letter of the name and scroll with  to the required entry.

▶ Press the display key **View**.

The detailed view with the complete entry opens. You can scroll through the entry with the control key .

The following data is shown, if available (in the sequence specific to the provider):

Nickname, name, first name, phone number, mobile number, VoIP number, street, house number, post code, city, company name, category, date of birth, e-mail, Jabber/Messenger ID.

Using other functions

Menu Press the display key.

The following functions can be selected with :

Edit nickname

You can edit or delete the nickname in an entry. Press **OK** to save the change.

Copy to Directory

Copy an entry to the local directory.

Please note

You can copy numbers from a public directory to your private net directory ([→ page 66](#)).

Calling up an entry in the net directory

Prerequisite: You have opened the net directory.

 Select entry (open the details view, if necessary).

 Press the talk key.

If the entry only contains one phone number, this is the one that is dialled.

If the entry contains more than one phone number (e.g., mobile number and phone number), they are offered to you for selection.

 Select the number to be dialled.

OK Press the display key.

The selected phone number is dialled.

Transferring the local directory to the private net directory

You can save entries in the local directory in vCard format as a vcf file on your PC using the Web configurator ([→ Web configurator on page 136](#)).

Several providers support functions on your Web pages that you can use to copy these files to the net directory.

Using the Gigaset.net directory

The handset is in idle status.

 Press and **hold**.

Or:

Menu ▶  **Online Contacts**

This opens the list of online directories.

Gigaset.net

Select and press **OK**.

The Gigaset.net directory opens.

Please note

- ◆ Calls to the Gigaset.net directory are always **free of charge**.
- ◆ You can also open the Gigaset.net directory by dialling **1188#9** (phone number of the Gigaset.net directory) and pressing the talk key .
- ◆ Creating an entry in the Gigaset.net directory for your phone, → [page 72](#).

If a connection cannot be established with the Gigaset.net directory, an error message is sent and the handset will return to idle status.

Searching for subscribers in the Gigaset.net directory

Once the connection to the Gigaset.net directory has been established, you are asked to enter a name that you want to search for.

Enter name:

Enter the name or part of a name (max. 25 characters).

Menu ▶ **Search**

Start the search.

If the search has been successful, a hit list is displayed containing all the names that begin with the specified character string.

Examples:

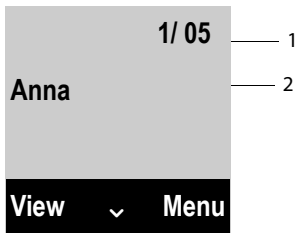

1. 1/5: Entry number/number of hits
2. Name of an entry, possibly abbreviated

You can scroll through the hit list with .

If **no matching** entry is found, a corresponding message is displayed. You have the following options:

- ▶ Press the display key **New** to start a new search.



Or

- ▶ Press the **Change** display key to change the search criteria. The name you previously entered in the search field is used as search criterion. You can then expand or edit as required.



If there are **too many matching** entries in the Gigaset.net directory, the message **Too many entries found** is displayed instead of a hit list.

- ▶ Press the **Refine** display key to start a refined search. The previously entered name is copied and you can edit/expand it.

Calling subscribers

-   Select the subscriber from the hit list and press the talk key.

Viewing the subscriber's number

-  Select the subscriber from the hit list.
- View** Press the display key.
-  Display the subscriber's name and number.

Please note

- ◆ Connections to Gigaset.net are always established via the Internet. This is regardless of the send connection configured/selected on your handset.
- ◆ You can open the Gigaset.net directory and establish connections, even if you have not entered yourself in the Gigaset.net directory.

Using other functions

Prerequisite: The hit list is displayed.

-  (Select entry) ▶ **Menu**

The following functions can be selected with :

Copy to Directory

Copy the number to the handset directory. The number and name (abbreviated if necessary) are copied to the local directory.

- ▶ Edit and save the entry where necessary.

The hit list is displayed again.

New Search

Start a search with a new name (→ [page 70](#)).

Refine Search

Start a refined search. The name previously searched for is copied and you can edit/expand it.

Own Details

→ "[Entering, editing and deleting own entry](#)" on [page 72](#).

Please note

If you select a Gigaset.net number from the local directory, the connection is automatically established via Gigaset.net (Internet).

Entering, editing and deleting own entry

You have the following options:

- ◆ Edit the name of your entry in the Gigaset.net directory.
- ◆ Delete your entry from the Gigaset.net directory.

Viewing your own entry

You are connected to the Gigaset.net directory and have performed a search. A hit list is displayed:

- ▶ **Menu** ▶ Select **Own Details** and press **OK**.

Your Gigaset.net number and, where applicable, your current name are displayed.

Entering/editing a name

Edit Press the display key.



Edit the name or enter a new name (max. 25 characters) and press **OK**.
You can delete the name with **Del.**

Data protection notice

If you enter a nickname at this point, it is stored on a central Gigaset server. The nickname appears in the Gigaset.net directory, and other subscribers that use the Gigaset.net service can call you using this nickname.

By entering your data, you agree to having your data saved. If you do not wish this to happen, you can cancel the operation at this point.

Cancel operation:

- ▶ Do **not** enter a name (or delete the name currently entered) and press the display key **OK**. You return to the hit list.

Or:

- ▶ Press and **hold** the end call key to return to the hitlist.

Further information about the Gigaset.net service data saved can be found at:
www.gigaset.net/privacy-policy

If there is no existing entry with this name in the Gigaset.net directory, the name is saved. A message to this effect is displayed. The handset switches to idle status.

If there is already an entry with this name, or the entered name contains impermissible characters, you are requested to enter a different name.

If an entry was created successfully in the Gigaset.net directory, the message "Saved" is displayed.

Please note

- ◆ If you delete the name, your entry is deleted from the directory. You are no longer "visible" to other Gigaset.net subscribers. However, you can still be reached via your Gigaset.net number. For instructions on displaying the number, → [page 152](#).
- ◆ You can also enter/edit your Gigaset.net name via the Web configurator.

Calling a Gigaset.net subscriber

You can call a Gigaset.net subscriber directly via the Gigaset.net directory (see above) or via their Gigaset.net number:



Enter the Gigaset.net number (including the #9) or select it from the local directory.



Press the talk key.

Every number ending with #9 is dialled via Gigaset.net.

SMS (text messages)

You can use your telephone to send and receive SMS messages via the fixed line and VoIP.

You must specify the line via which SMS are sent. You can receive SMS messages (abbreviation: SMS) via all of your phone's connections except for Gigaset.net.

Your telephone is delivered ready to send SMS messages as soon as the phone is connected to the fixed line. If you do not specify any settings the SMS messages are sent via the fixed line.

Prerequisites:

- ◆ Calling Line Identification is enabled for your fixed line connection. Calling Line Identification must not be withheld (→ [page 51](#)).
- ◆ Your network provider supports the SMS service (information on this is available from your network provider).
- ◆ You are registered with your service provider to send and receive SMS.
- ◆ To receive SMS messages, you must be registered with your service provider. This happens automatically when you send your first SMS.

Please note

If your phone is connected to a PABX, please read → [page 81](#).

Writing/sending SMS

Writing an SMS

Menu ▶  **SMS** ▶ **Write Message**

 Write SMS.

Please note



- ◆ For instructions on entering text and special characters, please see [page 157](#).
- ◆ An SMS may contain up to 160 characters.

Sending an SMS

Menu Press the display key.

Send Text Select and press **OK**.

SMS Select and press **OK**.

 /  Select number with area code (even if you are in that area) from the directory or enter directly.

OK Press the display key. The SMS is sent.

Please note

- ◆ If you are interrupted by an external call while writing an SMS, the text is automatically saved in the draft list.
- ◆ If the memory is full, or if the SMS function on the base is being used by another handset, the operation is cancelled. A corresponding message appears in the display. Delete SMS messages you no longer require or send the SMS later.

SMS status report

Prerequisite: Your network provider supports this feature.

If you have activated the status report, you will receive an SMS with a confirmation message after sending.

Activating/deactivating a status report

Menu ▶ **✉ SMS** ▶ **Settings**

Status Report

Select and press **OK** (= on).

Reading/deleting status report/saving number to directory

▶ Open the incoming message list (→ **page 78**) and then:

 Select SMS with **State OK** or **State not OK** status.

Read Press the display key.

◆ **Delete:**

Menu ▶ **Delete Entry** ▶ **OK**.

◆ **Copy to directory:**

Menu ▶ **Copy to Directory** ▶ **OK**.

◆ **Delete entire list:**

Menu ▶ **Delete List** ▶ **OK**.

Draft list

You can save an SMS in the draft list and edit and send it later.

Saving an SMS in the draft list

▶ You are writing an SMS (→ **page 74**).

Menu Press the display key.

Save Text Select and press **OK**.

After saving, the SMS editor will be displayed again with your SMS. You can continue writing the text and save it again. The SMS that was saved previously will be overwritten.

Opening the draft list

Menu ▶ **SMS** ▶ **Outgoing**

The first list entry is displayed, for example:

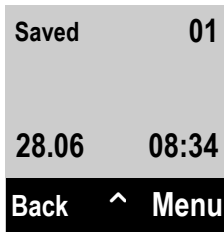

Reading or deleting SMS messages

▶ Open the draft list and then:

 Select SMS.

Menu ▶ **Read SMS**

Select and press **OK** to read the SMS message. Scroll through the SMS messages using .

Or delete the SMS with

Menu ▶ **Delete Entry** ▶ **OK**.

Writing/changing an SMS

▶ You are reading an SMS in the draft list.

Menu Open menu.

You have the following options:

Write Message

Write and then send or save a new SMS.

Use text

Edit the text of the saved SMS and then send it (page 74).

Character Set

Display text in the selected character set. The setting only applies to the current SMS.

Deleting the draft list

▶ Open the draft list and then:

Menu Open menu.

Delete List Select, press **OK** and confirm with **OK**. The list is deleted.

Sending SMS messages to an e-mail address

If your service provider supports the **SMS as e-mail** feature, you can also send your SMS messages to e-mail addresses.

The e-mail address must be at the beginning of the text. You must send the SMS to your SMS service centre's e-mail service.

Menu ▶  **SMS** ▶ **Write Message**



Enter the e-mail address. End the entry with a space or colon (depending on the service provider).



Enter the SMS text.

Menu Press the display key.

Send Text Select and press **OK**.

E-mail Select and press **OK**. If the number of the e-mail service is not entered (→ [page 80](#)), enter the number of the e-mail service.

OK Press the display key.

Sending SMS messages as a fax

You can also send an SMS to a fax machine.

Prerequisite: Your network provider supports this feature.

▶ You are writing an SMS (→ [page 74](#)).

Menu Press the display key.

Send Text Select and press **OK**.

Fax Select and press **OK**.



Select number from the directory or enter it manually. Enter the number with area code (even if you are in the same area).

OK Press the display key.

Receiving SMS

All received SMS messages are saved in the SMS inbox. If this is too long or is not transferred completely, it is split into individual messages. Since an SMS remains in the list even after it has been read, you should **regularly delete SMS messages from the list**.

The display tells you if the SMS memory is full.

Activating/deactivating first ringtone muting

Each incoming SMS on the fixed line connection is signalled by a single ring (ringtone as for external calls). If you accept the "call", the SMS is lost. To prevent this, suppress the first ring for all external calls.

SMS (text messages)

Menu Open main menu.

* 0 # - 0 5 # - 1 9

Press keys.

0 OK Make the first ringer audible.

Or:

1 OK Suppress the first ringer.

Incoming list

The SMS inbox contains:

- ◆ All received SMS messages regardless of the connection it was intended for. All received SMS messages are displayed on all handsets.
- ◆ SMS messages that could not be sent due to an error.

New SMS messages are signalled on all Gigaset handsets by the  icon (on the display) and an advisory tone.

Opening the incoming list with the key

 Press the message key.

The incoming list is displayed with the number of new entries (1) and the number of old, read entries (2) (example):

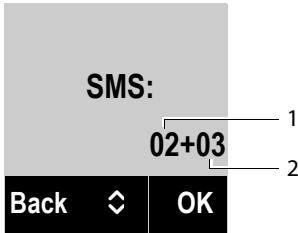

Open list with **OK**. An entry in the list is displayed with the number, status (old or new) and the date of receipt (example):

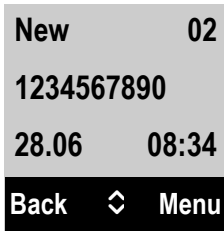

Opening the incoming list via the SMS menu

Menu ▶  SMS ▶ Incoming

Reading or deleting SMS messages

- ▶ Open the incoming list, then:

 Select SMS.

Menu ▶ Read SMS

Select and press **OK** to read the SMS message. Scroll through the SMS messages using .

After you have read a new SMS, its status changes to "old".

Or delete the SMS with

Menu ▶ Delete Entry ▶ **OK**.

Changing the character set

- ▶ Reading an SMS

Menu Press the display key.

Character Set

Text is shown in the selected character set.

Deleting the incoming list

- ▶ Open the incoming list.

Menu Open menu.

Delete List

Select, press **OK** and confirm with **OK**. **All new and old SMS messages** in the list are deleted.

Replying to or forwarding SMS messages

- ▶ Reading an SMS

Menu Press the display key.

You have the following options:

Reply

Write and send a new SMS to the sender ([page 74](#)).

Use text

Edit the text in the SMS and return it to the sender ([page 74](#)).

Send Text

Forward the SMS to another number ([page 74](#)).

Copying the number to the directory

Copying the sender's number

- ▶ Open the incoming list and select the SMS ([page 78](#)).

Menu ▶ Copy to Directory

- ▶ Complete the entry → [page 64](#).

Receiving notifications via SMS

You can arrange to be notified about missed calls by SMS.

Prerequisite: The caller's number (CLI) must have been transmitted in the missed call.

Notification is sent to your mobile phone or another phone with SMS functionality. You only need to save the telephone number to which you wish the notification to be sent.

Please note

Your provider will usually charge for SMS notifications.

Menu ▶  **SMS** ▶ **Settings** ▶ **Notification**

▶ You can enter data in the following fields:

Dest.call no.:

Enter the number (including area code) to which the SMS is to be sent.

Missed calls:

Select **On** if you require SMS notification.

OK Press the display key.

Warning

Do **not** enter your own network number for the notification of missed calls. This can lead to chargeable endless looping.

Setting the SMS service centre/defining the send line

SMS messages are exchanged between SMS service centres operated by service providers. You must enter the SMS service centre through which you wish to send and receive SMS messages into your phone. You can receive SMS messages from **every** SMS service centre that is entered, provided you have registered with your service provider. This happens automatically when you send the first SMS via the relevant service centre.

Your SMS messages are sent via the **SMS service centre** that is entered as the **active send centre**. However, you can activate any other SMS centre as the active send service centre to send a current message (→ [page 80](#)).

If no SMS service centre is entered, the submenu only consists of the entry **Settings**. Enter an SMS Service Centre (→ [page 80](#)).

Entering/changing SMS service centres

▶ Find out about the services and special functions offered by your service provider **before you make a new application** and/or before you delete pre-configured numbers.

Menu ▶  **SMS** ▶ **Settings** ▶ **Service Centres**

 Select SMS service centre (e.g., **SMS centre # 1**) and press **OK**.

▶ You can enter data in the following fields:

Active Send Serv. Centre:

Select **Yes** if SMS should be sent via the SMS service centre. For the SMS centres 2 to 4, the setting only applies to the next SMS.

SMS centre #:

Enter the number of the SMS service.

Email Centre:

Enter the number of the e-mail service.

Send via:

Select the fixed line or VoIP connection that you want to use to send the SMS messages.

OK Press the display key.

Please note

- ◆ If you have selected a VoIP connection and the attempt to transmit the SMS messages fails, the SMS is stored in the incoming message list with error status. Even if you have activated the **Automatic Fallback to Fixed Line** option (→ Web configurator), your telephone will not attempt to send the SMS via the fixed line.
- ◆ If the selected send connection is deleted from the configuration, the fixed line connection in the configuration is used.

Sending an SMS via another SMS service centre

- ▶ Activate the SMS service centre (2, 3 or 4) as the active send service centre.
- ▶ Send the SMS.

This setting only applies to the next SMS to be sent. Thereafter, the setting returns to **SMS centre # 1**.

SMS on a PABX

- ◆ You can only receive an SMS when **Calling Line Identification is forwarded** to the extension of the PABX (**CLIP**). The CLIP of the phone number for the SMS centre is evaluated in your **Gigaset**.
- ◆ Depending on your PABX, you may have to add the access code (outside line code) before the number of the SMS centre.
If in doubt, test your PABX, e.g., by sending an SMS to your own number: Once with the access code and once without.
- ◆ When you send SMS messages, your sender number may be sent without your extension number. In this case the recipient cannot reply to you directly.

Sending and receiving SMS on **ISDN PABXs** is only possible via the MSN number assigned to your base.

Activating/deactivating SMS function

If you deactivate the SMS function, you cannot send or receive any further SMS messages with your phone.

The settings you have made for sending and receiving SMS messages (e.g., the numbers of the SMS service centres) and the entries in the inbox and draft lists are saved even after deactivation.

Menu Open main menu.

*** 0 # -# 0 5 # -# 2 # 6**

Enter the digits.

0 OK Deactivate the SMS function.

Or:

1 OK Activate the SMS function (default setting).

SMS troubleshooting

Error codes when sending

E0	Calling Line Identification permanently restricted (CLIR) or Calling Line Identification not activated.
FE	Error occurred during SMS transfer.
FD	Connection to SMS centre failed, see self-help.

Self-help with errors

The following table lists error situations, possible causes and advice on troubleshooting.

<p>You cannot send messages.</p> <ol style="list-style-type: none"> You have not requested the CLIP service (Calling Line Identification Presentation). <ul style="list-style-type: none"> Ask your service provider to enable this service. SMS transmission has been interrupted (e.g., by a call). <ul style="list-style-type: none"> Re-send the text message. The network provider does not support this feature. No number or an invalid number is entered for the SMS service centre set as the active send centre. <ul style="list-style-type: none"> Enter the number (page 80).
<p>You receive an incomplete SMS.</p> <ol style="list-style-type: none"> Your phone's memory is full. <ul style="list-style-type: none"> Delete old SMS messages (page 76). The service provider has not yet sent the rest of the SMS.
<p>The SMS message is played back.</p> <ol style="list-style-type: none"> The "display call number" service is not activated. <ul style="list-style-type: none"> Ask your service provider to activate this function (chargeable). No agreement is in place between your mobile operator and your fixed line SMS service provider. <ul style="list-style-type: none"> Obtain information from your fixed line SMS service provider. Your terminal has been recorded by your SMS provider as having no fixed line SMS functionality i.e., you are not registered with the provider. <ul style="list-style-type: none"> Send any SMS to automatically register your telephone to receive SMS.
<p>Messages are only received during the day.</p> <p>The terminal is recorded in your SMS provider's database as having no fixed line SMS functionality i.e., you are not registered with the provider.</p> <ul style="list-style-type: none"> Obtain information from your fixed line SMS service provider. Send any SMS to automatically register your telephone to receive SMS.

E-mail notifications

Your phone will notify you when new e-mail messages have been received on your incoming e-mail server (i.e., POP3 server).

The prerequisite for displaying the e-mail messages on the handset is that you have used the Web configurator to save the name of the POP3 server (e.g., Yahoo, Gmail) and your personal access data (account name, password) in the phone (→ [page 136](#)). You can save access data for six different e-mail accounts on different POP3 servers on your phone. You can assign the e-mail accounts to different handsets.

You can set your phone to periodically connect to the POP3 servers and check whether you have new messages.

The receipt of a new e-mail message is displayed on the handsets assigned to the related e-mail account. An advisory tone sounds and the  icon is displayed on the idle display.

Please note

The  symbol is also displayed when you have new SMS messages.

You can display the sender, date/time of receipt and the subject for each e-mail in the incoming e-mail list (→ [page 85](#)).

Please note

If you have also activated the authentication of the phone with a POP3 server via a secure connection in the Web configurator (TLS authentication) and this fails, the e-mail messages are not downloaded to your phone.

In this case, pressing the flashing message key  will display the message **Certificate error Please check certificates in the web configurator.**

- ▶ Press the display key **OK** to confirm the message.
- ▶ Log in to the Web configurator (→ [page 119](#)). The Web page **Security** (→ [page 127](#)) tells you why the secure connection could not be established and what you can do.

Opening the incoming e-mail list

Prerequisites:

- ◆ The e-mail account is assigned to the handset.
- ◆ The incoming e-mail server uses the POP3 protocol.
- ◆ The name of the POP3 server and your personal access data (account name, password) are stored in the phone.

On the handset:

Menu ▶ **Settings** ▶ **E-mail** ▶ **E-mail 1 / .../E-mail 6**

Or, if there are new e-mail messages:

✉ ▶ **E-mail 1 / .../E-mail 6**

Please note

Only the e-mail lists **E-mail 1 / .../E-mail 6** of the e-mail accounts assigned to the handset are displayed.

The phone establishes a connection to the POP3 server. A list of e-mail messages that are stored there is displayed.

New unread messages appear above old read messages. The most recent entry appears at the head of the list.

The following details are displayed for each e-mail: name or e-mail address of the sender (one line, abbreviated if necessary) and date and time (date and time will only display correct values if sender and recipient are located in the same time zone).

Example display:

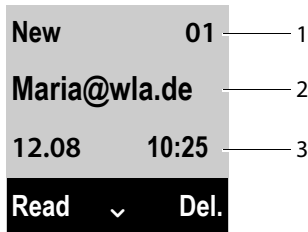

1 Status of the message and sequential number.

All e-mail messages that were not present in the incoming e-mail server when the inbox was last opened are identified as **New**. All other e-mails are **Old**, regardless of whether or not they have been read.

2 E-mail address or name transmitted by the sender (abbreviated if necessary)

3 Date and time of receipt of e-mail message

If the inbox on the POP3 server is empty, **No entries** will appear in the display.

Please note

Many e-mail providers activate spam protection measures by default. E-mail messages classified as spam are stored in a separate folder and are therefore not shown in the incoming mail list.

Some e-mail providers allow you to deactivate spam protection or show spam e-mails in the incoming mail list.

Other e-mail providers may send a message to the inbox when a new spam e-mail is received. This is to inform you that a suspected spam e-mail has been received.

The date and sender of this mail are repeatedly updated, so that it is always displayed as a new message.

Messages when establishing a connection

The following problems may occur when connecting to the POP3 server. The messages are shown in the display for a few seconds.

Server not accessible

The connection to the POP3 server could not be established. This may have the following causes:

- Incorrect entry for the name of the POP3 server (▶ [Web configurator, page 136](#)).
- Temporary problems with the POP3 server (server is down or is not connected to the Internet).
 - ▶ Check settings in the Web configurator.
 - ▶ Try again later.

Not possible!

The resources your phone requires to make the connection are busy, e.g.:

- One of the registered handsets is currently connected to the POP3 server.
 - ▶ Try again later.

Login failed

Error when logging in to the POP3 server. This may have the following cause:

- Incorrect entries for name of POP3 server, username and/or password.
 - ▶ Check settings (→ [Web configurator](#)).

Parameters incomplete

Incomplete entries for name of POP3 server, username and/or password.

- ▶ Check/add to settings (→ [Web configurator](#)).

View the message header of an e-mail

Prerequisite: You have opened an incoming mail list (→ [page 85](#)).

 Select an e-mail entry.

Read Press the display key.

The subject of the e-mail message (maximum 120 characters) is displayed.

Example for the display on the handset:

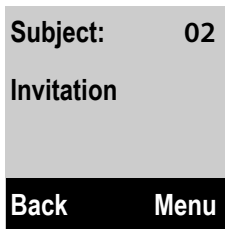

Back Press the display key to return to the incoming message list.

Viewing e-mail sender's address

Prerequisite: You have opened the e-mail notification to read it (→ [page 87](#)).

Menu ▶ **From**
Select and press **OK**.

The sender's e-mail address is displayed, over several lines if necessary (maximum 60 characters).

Back Press the display key to return to the message header.

Deleting e-mail messages

Prerequisite: You have opened the incoming e-mail list (→ [page 85](#)) or the header or sender's address for an e-mail is displayed (→ [page 87](#)):

Del. Press the display key.

Or:

Menu ▶ **Delete**
Select and press **OK**.

OK Press the display key to confirm the security prompt.

The e-mail is deleted from the POP3 server.

Using the network mailbox

Some providers offer answering machines on the network – network mailboxes. You should set up network mailboxes for your fixed line connection and for each of your VoIP connections.

You must save the phone number for these network mailboxes in your phone.

You need to **request** the network mailbox for your fixed line connection from your network provider.

You can activate/deactivate the network mailboxes for your VoIP connections using the handset or the Web configurator.

Activating/deactivating network mailboxes, entering numbers

On the handset, you can manage the network mailboxes that are assigned to one of its receive connections.

Menu ▶  **Voice Mail** ▶ **Network Mailbox**

The list of connections (VoIP and fixed line) that are assigned to the handset as receive connections is displayed. **Net AM xxx** is displayed, where xxx is replaced by the respective standard name of the connection (**Net AM IP1** to **Net AM IP6**, **Net AM Fixed Line**).



If several receive connections are assigned to the handset, select connection and press **OK**.

You have selected a VoIP connection:

- ▶ You can enter data in the following fields:

Status

Use  to select **On/Off** for activating/deactivating the network mailbox.

Network Mailb.

The number that is currently stored for the network mailbox is displayed.

Enter or change the phone number for the network mailbox if necessary.

With some VoIP providers your network mailbox phone number is downloaded together with the general VoIP provider data, saved to your base and displayed under **Network Mailb..**

- ▶ Press the display key **OK**.

You have selected the fixed line network connection:



Enter or change the phone number for the network mailbox if necessary.



Press the display key.

You cannot activate/deactivate the network mailbox for the fixed line network connection via the handset. For instructions on activating/deactivating the network mailbox, see the information provided by the network provider.



Configuring a network mailbox for fast access

With fast access you can dial a network mailbox directly.

Assigning key 1, changing assignment

Fast access settings are handset-specific. You can assign a different network mailbox to key  on each registered handset.



No network mailbox is preconfigured for fast access in the default settings.

 Press and **hold** key .

Or:

 ►  **Voice Mail** ► **Set Key 1**

The list of VoIP connections and the fixed line connection assigned to the handset as receive connections is displayed. **Net AM xxx** is displayed, where xxx is replaced by the respective standard name of the connection (**Net AM IP1** to **Net AM IP6**, **Net AM Fixed Line**).

 Select entry and press **OK** ( = on).

If a number is already stored for this network mailbox, fast access is activated immediately.

 Press and **hold** the end call key (idle status).

If no number is saved for the network mailbox, you are asked to enter the number of the network mailbox.

 Enter the number for the network mailbox.

OK Press the display key.

 Press and **hold** the end call key (idle status).

Fast access is activated.

Calling the network mailbox via fast access

 Press and **hold**.

If you have set a network mailbox for fast access, you are connected directly to this network mailbox. Handsfree mode is activated.

 If necessary, deactivate handsfree mode.

You hear the network mailbox announcement.

Displaying new messages in the handset's idle display

If a new message is present on one of the network mailboxes assigned to the handset via its receive connection, the  icon and the number of new messages are generally shown on the idle display.

Calling the network mailbox

With the message key

Under the message key  you will find a list for each network mailbox that fulfils the following prerequisites:

- ◆ The corresponding connections are assigned to the handset as receive connections.
- ◆ The network mailbox phone number is saved on the phone.

You can use the list to call the network mailboxes directly and listen to the messages.

 Press the message key.

Mailbox IP 1 / ... / Mailbox IP 6 / Mailbox

Select the network mailbox entry and press **OK**.

Via the menu

Prerequisite: The network mailbox phone number is saved on the phone.

Menu ▶  **Voice Mail** ▶ **Play Messages**

Net AM IP1 / ... / Net AM IP6 / Net AM Fixed Line

Select the network mailbox entry and press **OK**.

In both cases you are connected directly to the network mailbox and hear its announcement. Messages can generally be played back using your handset keypad (digit codes). Listen to the announcement.

Please note

- ◆ The network mailbox is automatically called via the corresponding connection. An automatic area code specific to your phone is **not** prefixed.
 - ◆ Network mailbox messages can generally be played back using your phone's keypad (digit codes). For VoIP, you need to define how the digit codes should be converted to DTMF signals and transmitted (→ **page 134**).
- Ask your VoIP provider which type of DTMF transmission it supports.

ECO DECT

You are helping to protect the environment with your Gigaset.

Reducing energy consumption

Your telephone has a power-saving adapter plug and uses less power.

Reducing radiation

The radiation from your telephone is reduced **automatically**: The closer the handset is to the base, the lower the radiation.

You can reduce the radiation from the handset and the base even more by using Eco Mode:

Eco Mode

Reduces the radiation of the base and handset by 80% – whether you are making a call or not. **Eco Mode** reduces the range of the base by approx. 50%. Using **Eco Mode** always makes sense when a reduced range is sufficient.

Switching off radiation

Eco Mode+

When you activate **Eco Mode+**, the radiation (DECT transmission power) of base and handset is switched off automatically and only turns on when calls are made. This is also true when multiple handsets are used, if the handsets support **Eco Mode+**.

Eco Mode / Eco Mode+ can be activated/deactivated independently of one another and can also be used with multiple handsets.

Activating/deactivating Eco Mode:

Menu ▶ **Settings** ▶ **Eco Mode**



OK Press the display key (☑ = on).

Activating/deactivating Eco Mode+:

Menu ▶ **Settings** ▶ **Eco Mode+**

OK Press display key (☑ = on).

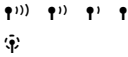
Status displays

Display icon	
	<p>Reception strength:</p> <ul style="list-style-type: none"> - Good to poor - No reception
	<p>Eco Mode+ enabled (displays instead of the reception strength icon when in idle status)</p>

Please note

- ◆ When using **Eco Mode+** you can ensure that the range of the base is sufficient by pressing and **holding** the talk key . You hear the dialling tone if the base can be reached.
- ◆ When **Eco Mode+** is enabled:
 - Call setup is delayed by approx. 2 seconds.
 - Handset standby time is reduced by approx. 50%.
- ◆ Registering handsets that do not support **Eco Mode+** causes the mode to be deactivated on the base and all other handsets.
- ◆ Activating **Eco Mode** reduces the range of the base.
- ◆ **Eco Mode / Eco Mode+** and repeater support (→ **page 110**) cancel each other out, i.e., if you use a repeater, you cannot use **Eco Mode** and **Eco Mode+**.

Using the handset as an alarm clock

Prerequisite: The date and time have already been set (page 33).

Activating/deactivating the alarm clock

Menu ▶ Alarm Clock ▶ Activation (☑ = on)

After you activate the alarm clock, the menu for setting the wake-up time opens automatically.

The ☺ icon and wake up time are shown on the display.

A wake up call is signalled on the display (→ page 6), with the selected ringtone volume and melody (page 102). The wake up call sounds for 60 seconds. If no key is pressed, the wake up call is repeated twice at five minute intervals and then switched off.

During a call, the wake-up call is only signalled by a short tone.

Setting the wake-up time

Menu ▶ Alarm Clock ▶ Wake up time



Enter the wake up time in hours and minutes, then press **OK**.

Deactivating the wake-up call/repeating after a pause (snooze mode)

Prerequisite: A wake-up call is sounding.

Off Press the display key. The wake-up call is deactivated.

Or

Snooze Press the display key or any key. The wake-up call is deactivated and then repeated after 5 minutes. After the second repetition the wake-up call is deactivated completely.

Using multiple handsets

Registering handsets

You can register up to six handsets with your base station. **Each** additional handset must be registered with the base in order for it to work properly!

Each registered device is assigned an internal number (1 - 6) and an internal name (INT 1 – INT 6). You can change the names.

When you register a Gigaset handset, the base transfers entries for the following online directories to the local directory on the handset to enable you to use the online directories on your new handset as well.

Prerequisite: The handset can send and receive directory entries (see handset user manual).

- ◆ The currently set online directory (→ **page 136**) with a provider-specific name.
- ◆ The Yellow Pages currently set (→ **page 136**) with a provider-specific name.
- ◆ The private directory currently set with the name **Prv.NetDir**.
- ◆ The Gigaset.net directory with the name **Gigaset.net**.

Registering a Gigaset handset to a Gigaset A510 IP

You must manually initiate registration of the handset on the base (1) and on the handset (2).

Once registration is complete, the handset returns to idle status. The handset's internal number is shown on the display, e.g., INT 1. If not, repeat the procedure.

1) On the base

- ▶ Within 60 seconds, press and **hold** the register/paging key on the base (→ **page 8**) (for approx. 3 seconds).

2) On the handset

Menu ▶ **Settings** ▶ **Registration** ▶ **Register Handset**

 If required, enter the system PIN for the base (the default is **0000**) and press **OK**.

The display shows **Handset is registering**.

Registering other handsets

You can manually register other Gigaset handsets and handsets for other devices with GAP functionality as follows.

1) On the base

- ▶ Press and **hold** the register/paging key on the base (→ **page 8**) (approx. 3 sec.).

2) On the handset

- ▶ Start to register the handset as described in its user guide.

De-registering handsets

You can de-register all other registered handsets from each of the registered Gigaset handsets.

Menu ▶ **Settings** ▶ **Registration** ▶ **De-register Handset**



Select the internal number you wish to de-register and press **OK**.
(The handset you are currently using is highlighted with <).)



Enter the current system PIN if necessary and press **OK**.



Press the display key.

Locating a handset ("paging")

You can locate your handset using the base.



- ▶ **Briefly** press the registration/paging button on the base (→ **page 8**).
- ▶ All registered handsets will ring at the same time ("paging"), even if the ring-tones are switched off.

The current (local) **IP address** for the base appears in the handset displays.

Ending paging

- ▶ Press the registration/paging key on the base station **briefly**.

Or:

- ▶ Press the talk key  or end call key  on the handset.

Or:

- ▶ Press the display key **Silence** on the handset.

Or:

- ▶ Do not press any key on the base or handset:
After approx. 30 seconds, the paging call will end **automatically**.





Please note

- ◆ An incoming external call will not interrupt the paging process.
- ◆ If there are already two internal connections between the handsets, then paging is not possible.
- ◆ A paging call is also signalled acoustically on handsets where the ringtone is permanently deactivated.





Making internal calls

If you have multiple handsets registered to the base, you can make **internal** calls free of charge.

Calling a specific handset

-  Initiate internal call.
-  Enter the number of the handset.
- Or:**
-  Initiate internal call.
-  Select handset.
-  Press the talk key.

Calling all handsets ("group call")

-  Press and **hold**.
- Or:**
-  Initiate internal call.
-  Press the star key.
- Or:**
-  Initiate internal call.
- Call All** Select
-  Press the talk key.



All handsets are called.

Ending a call

-  Press the end call key.

Transferring a call to another handset/making an internal consultation call

You are talking to an external participant and can call an internal participant at the same time to forward the call or to consult.

-  Open the list of handsets.
The external participant is put on hold.
-  Select a handset or **Call All** and press **OK**.

When the internal participant answers:

- ▶ If necessary, announce the external call.

Either

-  Press the end call key. The external call is transferred to the other handset.

or

-  Press the display key. You are reconnected with the external participant.

When transferring a call, you can also press the end call key  before the internal participant answers.

If the internal participant does not answer or the line is busy, the call will automatically return to you.

Accepting a waiting call

If you receive an **external** call during an **internal** call, you will hear the call waiting tone (short tone). With Calling Line Identification, the caller's number will appear in the display.

Ignoring the external call

Reject Press the display key.

The call waiting tone is turned off. You remain connected with the internal participant.

For calls to a VoIP connection: the external caller hears the busy tone.

For calls to the fixed line connection:

The call continues to be signalled on the other registered handsets.

Accepting an external call/putting an internal party on hold

Accept /  Press the display key or the talk key.

You are connected to the external caller. The internal call is placed on **hold**.

Internal call waiting during an internal/external call

If an internal party attempts to call you while you are involved in an external or internal call, this call is shown on the display (internal call waiting). You can either accept or reject this call.

Press any key to make this prompt disappear from the display.

You must end the current call to accept the internal call. Then the internal call is signalled as per usual. You can accept the call.

Setting up a conference call

You are conducting a call with an **external** participant and have set up an internal conference call, or during an internal call you have accepted an external waiting call.

You have the following options:





- ◆ Swap between both participants:
 - ▶ Use  to switch between the participants (call swapping).
- ◆ Set up a conference call:
 - ▶ Press the display key **Conf.** to establish the conference call.
- ◆ Ending a conference call
 - ▶ Press the **EndCon** display key to return to call swap mode.

Or:

- ▶ If an **internal** participant presses the end call key , the other handset remains connected to the external participant.









Changing the name of a handset

The names "INT 1", "INT 2" etc. are assigned automatically on registration. You can change these names. The name must be no longer than 10 characters. The changed name is displayed in every handset's list.

-  Open the list of handsets. Your own handset is indicated by <.
-  Select handset.
-  Open menu.
- Rename**
-  Enter the name.
-  Press the display key.

Changing a handset's internal number

A handset is **automatically** assigned the lowest free internal number from 1–6 during registration. If all numbers are in use, then the number 6 is overwritten as long as this handset is in idle status. You can change the internal numbers of all registered handsets (1–6).

-  Open the list of handsets. Your own handset is indicated by <.
-  Open menu.
- Assign Handset No.**
- Select and press .
-  Select the handset, if necessary.
-  /  Select or enter the internal number.
-   Switch to another handset, if necessary, and select the number etc.
-  Press the display key to save the entry.

You will hear the error tone if an internal number has been assigned twice.

- ▶ Repeat the procedure with a free number.

Handset settings

Your handset comes with default settings, but you can change the settings to suit your individual requirements.

Changing the display language

You can view the display texts in different languages.

▶ **Menu** ▶  **Settings** ▶ **Language**

The current language is indicated by .

 Select a language and press **OK**.

If you accidentally choose a language you do not understand:

 ▶    

 Select the correct language and press **OK**.

Setting the display/screensaver

Menu ▶ **Settings** ▶ **Display** ▶ **Screensaver**

The screensaver replaces the idle status display. You can choose between **No Screensaver**, **Digital Clock** and **Live Ticker**.

For **Live Ticker**: Approx. 10 seconds after the handset returns to idle status, a digital clock and (if available) text information from the Internet appear on the display (e.g., weather reports, RSS feeds). The text information is displayed below the clock as a scrolling message.

The text information is initially displayed once. Then only the digital clock is displayed.

The display of the text information is started again when:

- ◆ New information is received
- ◆ You remove the handset from the charger or place it in the charger
- ◆ You press any key on the handset

The display backlight switches itself on.

You can collate the text information as required (→ "**Customising info services**", [page 136](#)). The default setting is the weather report.

Please note

- ◆ If you have set the screensaver **Live Ticker**, and you want to make a call or change settings on the handset, you may, if necessary, need to repeat the first key press (e.g., press the **Menu** key twice to open the main menu). The first key press activates the display of text information.
- ◆ The screensaver is not displayed in certain situations, e.g., during a call or if the handset is de-registered.
- ◆ If the screensaver is concealing the display, press the end call key  briefly to show the idle display with time and date.

Configuring the display/colour and contrast

Menu ▶ **Settings** ▶ **Display**

You have the following options:

Colour Schemes

You can view the display backlight in different colours. Four colour schemes are available.

Contrast

Nine contrast settings are available.

Quickly accessing functions

The **Redial** function (open the redial list) is preset on the left display key of your handset. You can change the configuration, i.e. assign a different function to the display key.

To start this function, you then simply need to press the button.

Prerequisite: The handset has a connection to the base.

- ▶ When the handset is in idle status, press and **hold** the left display key. The list of possible key assignments is opened.
- ▶ Select a function with the control key  and press **OK**.

You can select the assignment for the display keys from the following functions:

Line Selection

Assign the list of connections for your phone to a key.

Select the send connection for each call from the list (→ [page 44](#)).

Display key: **Sel.Cn.**

Call Lists

Open call lists.

Display key: **Calls**

Withhold Number (VoIP)

Withhold calling line identification for next call (→ [page 54](#)):

Menu ▶  **Select Services** ▶ **Withhold No. Next Call**

Display key: **Withld.**

Call Divert

Prerequisite: The provider supports call divert.

Assign the menu for setting and activating/deactivating call divert to a key (→ [page 51](#)):

Menu ▶  **Select Services** ▶ **Call Divert**

Display key: **CallDiv**

E-mail

Opens the e-mail submenu for receiving and reading e-mail notifications (→ [page 85](#)):

Menu ▶  **Settings** ▶ **E-mail**

Display key: **E-mail**

The selected function is displayed in the bottom display line above the display key. To start the function, you then simply need to press the button. In idle status nothing is displayed with the left display key if the handset is out of range of the base or the base is not connected to the mains power supply.

Starting a function

When the handset is in idle status:

- ▶ Press the display key **briefly**.

The submenu opens and the function is performed.

Activating/deactivating auto answer

If you activate this function, when you receive a call you can simply lift the handset out of the charging cradle without having to press the talk key .

Menu ▶ **Settings** ▶ **Telephony** ▶ **Auto Answer**

OK Press the display key ( = on).

Changing the handsfree/earpiece volume



You can set the volume for handsfree mode and earpiece mode to five different levels.

In idle status:

 ▶ **Call Volume**



Earpiece Volume / Handsfree Volume

Select and press **OK**.

 Set the volume (e.g., volume 3 = .

OK Press the display key to save the setting.

During a call via the earpiece or in handsfree mode:

 Press the control key to open the menu for setting the volume. Set the earpiece or handsfree volume by pressing .

The setting will automatically be saved after approximately 3 seconds or press the display key **OK**.

Please note

You can also set the call volume using the

Menu ▶ **Settings** ▶ **Audio Settings** menu.

Changing ringtones

◆ Volume:

You can choose between five volumes (e.g., volume 3 = ■■■) and the "crescendo" ring (volume increases with each ring 6 = _____).

◆ Ringtones:

You can select from a list of pre-loaded ringtones and melodies.

You can set different ringtones for the following functions:

◆ Internal calls

◆ Alarm clock

◆ For external calls to each individual receive connection on the phone (**Fixed line, IP1 to IP6, Gigaset.net**)

Setting the ringtone volume

The ringtone (ringer) volume is the same for all types of ring.

In idle status:

 ▶ **Ringer Volume**

 Set the volume.

OK Press the display key to save the setting.

Please note

You can also adjust the ringtone volume via the

Menu ▶ **Settings** ▶ **Audio Settings** menu.

Setting ringtone melody

Set different ringtone melodies for external calls, internal calls and the alarm clock.

For internal calls and the alarm clock

In idle status:

 ▶ **Ringtones (Handset)**

Internal Calls / Alarm Clock

Select and press **OK**.

 Select melody and press **OK** (☑ = selected).

For external calls

In idle status:

 ▶ **Ringtones (Handset)**

External Calls

Select and press **OK**.

 can be used to select the following:

Melodies

Select receive connection and press **OK**. You can set the ringtone as described above.

Time Control

You can specify a time period when you do not want the telephone to signal external calls e.g., during the night.

Activation is switched on or off by pressing **OK** (☑ = activated)

Settings

Ringer off from: /Ringer off until:

Enter time in 4-digit format.

Please note

During this period, you will continue to receive calls from numbers to which you have assigned a personalised melody/background colour in the directory (VIP).

Anonymous Calls Silent

You can set your handset so that it doesn't ring for calls where Calling Line Identification has been withheld. The call will only be signalled on the display.

Switch the **Calls Silent Anonymous** function on or off by pressing **OK**

(☑ = activated).

Please note

You can also set the ringtones via the

Menu ▶ **Settings** ▶ **Audio Settings** menu.

Activating/deactivating the ringtone

You can:

- ◆ Permanently deactivate the ringtone in idle status or when receiving a call
- ◆ Deactivate the ringtone for the current call only

The ringtone cannot be reactivated while a call is in progress.

Deactivating the ringtone permanently



Press and **hold** the star key. The icon appears in the display.

Reactivating the ringtone



Press and **hold** the star key.

Deactivating the ringtone for the current call



Press the display key.

Activating/deactivating advisory tones/battery warning tones

Your handset uses advisory tones to tell you about different activities and statuses. These can be activated and deactivated independently of each other:

◆ Advisory Tones

- **Confirmation tone:** At the end of an entry/setting and when an SMS or a new entry arrives in the call list
- **Error tone:** When you make an incorrect entry
- **Key click:** Every key press is confirmed.

◆ Battery Low

The battery needs charging.

▶ Advisory Tones / Battery Low

Select and press **OK** to activate or deactivate (= activated).

The **menu end tone** when scrolling at the end of a menu cannot be deactivated.

Restoring the handset default settings

You can reset any individual settings and changes that you have made.

The following settings are **not** affected by a reset:

- ◆ Registering the handset to the base
- ◆ Date/time
- ◆ Entries in the directory, call lists, SMS lists

Menu ▶ **Settings** ▶ **System** ▶ **Reset Handset**

OK Confirm prompt.

Setting the base

The base settings are configured using a registered Gigaset handset.

Setting the date/time

The date and time must be set in order to show the correct time for incoming calls, for example.

There are two methods of setting the date and time:

- ◆ Your base receives the date and time from a time server on the Internet, providing that the base is connected to the Internet and synchronisation with a time server is enabled (default setting; → [page 136](#)).
- ◆ You can also change the date and time manually via the menu on one of the registered handsets.

Your base accepts the new time and transfers this information to the connected handsets.

Setting the date and time on the handset

If the date and time have not yet been set on the handset, the **Time** display key appears.

Time Press the display key.

Or:

Menu ▶  **Settings** ▶ **Date/Time**

▶ You can enter data in the following fields:

Enter Date:

Enter day, month and year as an 8-digit number via the keypad e.g.,

for 14/01/2011 and press **OK**.

Enter Time:

Enter the hours and minutes in 4-digit format via the keypad, e.g., for 07:15 am.

▶ Press the display key **OK** to save the settings.

Protecting the telephone from unauthorised access

Protect the phone system settings with a system PIN known only to you. If a system PIN is **not equal to 0000**, you have to enter it if you register or de-register a handset, change local network settings, perform a firmware update or reset the phone to default settings.

Please note

If the PIN for your phone is 0000 (default setting), you are only requested to enter the PIN when you reset the base and when you register handsets.

Changing the system PIN

You can change the phone's 4-digit system PIN (default setting: 0000) to a 4-digit PIN known only by you.

Menu ▶  **Settings** ▶ **System** ▶ **System PIN**



If the current system PIN is not 0000:

Enter the current system PIN and press **OK**.



Enter new system PIN.



Press the display key.

Activating/deactivating music on hold

Menu ▶  **Settings** ▶ **Telephony** ▶ **Music on hold**

Press **OK** to activate or deactivate the music on hold (= on).

Setting the base's IP address in the LAN

Prerequisite: Your base is connected to a router or a PC (→ [page 20](#)).

An IP address is required in order for the LAN to "recognise" your phone.

The IP address can be assigned to the phone automatically (by the router) or manually.

- ◆ If the address is assigned **dynamically**, the router's DHCP server automatically assigns an IP address to the phone. The base's IP address can be changed according to router settings.
- ◆ With manual/**static** assignment, you assign a static IP address to the phone. This may be necessary depending on your network configuration (e.g., if your phone is connected directly to a PC).

Please note

To assign the IP address dynamically, the DHCP server on the router must be activated. Please also read the user manual for your router.

Menu ▶  **Settings** ▶ **System** ▶ **Local Network**



If the system PIN is not 0000: enter the system PIN and press **OK**.

▶ You can enter data in the following fields:

IP addr. type

Select **Static** or **Dynamic**.

For **IP addr. type Dynamic**:

The fields **IP address**, **Subnet mask**, **DNS server** and **Default gateway** show the current settings that the phone obtained from the router. These settings cannot be changed.

For **IP addr. type Static**:

You must manually define the IP address and the subnet mask for the phone as well as the default gateway and DNS server in the following fields.

For **IP addr. type** **Static**:

IP addr. (1/2)

Enter the first two components of the IP address that is to be assigned to the phone (overwriting the current settings).

The default is 192.168.

For information on the IP address, see the glossary (→ [page 165](#)).

IP addr. (2/2)

Enter the last two components of the IP address (overwriting the current settings).

The default is 001.002.

Subnet mask (1/2), Subnet mask (2/2)

Enter the subnet mask to be assigned to the phone (overwriting the current settings).

The default setting is 255.255.255.0

For information on the subnet mask, see the glossary (→ [page 169](#)).

DNS server (1/2), DNS gateway (2/2)

Enter the IP address for the preferred DNS server. The DNS server (Domain Name System, → [page 161](#)) converts the symbolic name of a server (DNS name) into the public IP address for the server when the connection is made.

You can specify your router's IP address here. The router forwards phone address requests to its DNS server.

The default is 192.168.1.1.

Default gateway (1/2), Default gateway (2/2)

Enter the IP address for the default gateway (→ [page 163](#)) through which the local network is connected to the Internet. This is generally the local (private) IP address for your router (e.g., 192.168.1.1). Your phone requires this information to be able to access the Internet.

The default is 192.168.1.1.

▶ Press **OK** to save the settings.

Please note

You can also make local network settings via the Web configurator (→ [page 126](#)).

Configuring VoIP connections, assigning send and receive connections

You can configure up to six VoIP connections on your phone, i.e., you can assign up to six VoIP phone numbers to your phone.

You need to set up an IP account (VoIP account) with a VoIP provider for each VoIP connection. You must save the access data for this IP account on your phone.

You can assign the VoIP phone numbers to the registered handsets as send and/or receive connections.

The VoIP wizard supports you in configuring VoIP connections and assigning them to the handsets:

Menu ▶  **Settings** ▶ **Telephony** ▶ **VoIP Wizard**

The procedure for the VoIP wizard is described on [page 23](#).

Each time you run the VoIP wizard you can configure/reconfigure **one** VoIP connection (IP account).

- ▶ Restart the VoIP wizard if you wish to configure/reconfigure another VoIP connection.

Please note

- ◆ You can also use the Web configurator to configure and manage VoIP connections (→ [page 129](#)).
- ◆ You can change the assignment of send and receive connections to the handsets via the Web configurator (→ [page 131](#)).

Number assignment:

- ◆ If a new connection is configured, it is automatically assigned as the receive connection to all handsets.
- ◆ During registration, each handset is automatically assigned the fixed line connection as a send connection and all base connections as receive connections.
- ◆ The Gigaset.net connection is not included in the selection for the send connections. Gigaset.net numbers (suffix #9) are automatically dialled via Gigaset.net.
- ◆ If the VoIP connection assigned to a handset as a send connection is deleted or deactivated, the fixed line connection is assigned as the send connection.
- ◆ If a connection is not assigned as the receive connection to any internal party, calls on this connection will not be signalled.

Automatic update for the VoIP provider settings

Via the Web configurator of the phone, you can activate an automatic version check for the VoIP provider settings (provider profiles) loaded to your phone (→ [page 130](#)).

After the first download of the VoIP provider settings, your phone will check daily whether a newer version of the files for your VoIP providers is available from the Internet on the configuration server.

If there is new provider data, the idle display on the handset displays the message **New profile available**. The  message key flashes.

 Press the key.

Yes Press the display key to confirm the subsequent prompt.

 If the system PIN is not 0000: enter the system PIN and press **OK**.

The new data for your VoIP provider will be downloaded and saved on the phone.

A profile update will only be started if no other profile or firmware update is taking place at the time.

Updating the phone firmware

Prerequisite: The phone is connected to the Internet (i.e., connected to a router, → [page 20](#)).

If necessary, you can update your phone's firmware.

The firmware update is downloaded directly from the Internet by default. The relevant Web page is preconfigured in your phone.

Prerequisite:

The phone is in idle status i.e.,

- ◆ No calls are being made.
- ◆ There is no internal connection between the registered handsets.
- ◆ The base menu is not open in any of the handsets.

Starting the firmware update manually

Menu ▶  **Settings** ▶ **System** ▶ **Firmware Update**

Select and press **OK**.

 If the system PIN is not 0000: enter the system PIN and press **OK**.

The phone establishes a connection to the Internet.

Yes Press the display key to start the firmware update.

Please note

- ◆ The firmware update can take up to six minutes, depending on the quality of your DSL connection.
- ◆ When updating from the Internet, checks are made to ensure that no newer version of the firmware exists. If this is not the case, the operation is terminated and a message is issued to that effect.
- ◆ During the update, the handsets temporarily lose their connection to the base. The base is restarted.
- ◆ You can also reset the firmware via the Web configurator, i.e., reload the previous firmware version or the firmware version that was loaded as default to the phone.

Updating firmware automatically

Your phone will check daily whether a newer firmware version is available from the Internet on the configuration server. If firmware updates are available, the message **New firmware available** is displayed in the idle display of the handset.



Press the key.



Press the display key to confirm the subsequent prompt.



If the system PIN is not 0000: enter the system PIN and press **OK**.

The firmware is uploaded to your phone.

Please note

If the telephone is not connected to the Internet at the time when the check for new firmware is to be performed (e.g., because the router is deactivated), the check is performed as soon as the phone is reconnected to the Internet.

You can deactivate the automatic version check via the Web configurator.

Repeater support

You can increase the range and signal strength of your phone using a repeater. You will need to activate repeater mode. This will terminate any calls that are in progress at the time.

Prerequisite: Eco Mode(+) is deactivated.

Menu ▶ **Settings** ▶ **System** ▶ **Repeater Mode**



Press the display key to activate or deactivate repeater mode (= on).



Press the display key to confirm the prompt.

Please note

- ◆ Repeater support and **Eco Mode/Eco Mode+** (→ [page 91](#)) cancel each other out, i.e., both functions cannot be used at the same time.
- ◆ The default encrypted transmission setting is deactivated when repeater mode is activated.

Restarting the base

When the handset is in idle status:

Menu ▶  **Settings** ▶ **System** ▶ **Base Restart**

The firmware for the base is then restarted. This process takes about 20 seconds.

Resetting the base to the default settings

The individual settings are reset.

Resetting the base station via the menu

When the settings are restored:

- ◆ Handsets are still registered
- ◆ The system PIN is not reset

The following settings in particular are reset to the default settings (you can change the settings marked "*" via the Web configurator):

- ◆ The entered VoIP connections (are deleted)
- ◆ The assignment of send and receive connections
- ◆ Audio settings for VoIP connections *
- ◆ DTMF settings *
- ◆ Settings for the local network
- ◆ The names of the handsets
- ◆ SMS settings (e.g., SMS service centres)
- ◆ **Eco Mode** is deactivated
- ◆ **Eco Mode+** is deactivated
- ◆ PABX connection settings
- ◆ Digit and display key assignments as well as the  key
- ◆ Settings for select services: Call diverts (with the exception of fixed line services activated/deactivated by a call to your provider)

The following lists are deleted:

- ◆ SMS lists
- ◆ Call lists

Menu ▶  **Settings** ▶ **System** ▶ **Base Reset**



Enter the system PIN and press **OK**.



Press the display key.

After the reset, the base is restarted. The restart takes around ten seconds.

The installation wizard is launched (→ [page 22](#)).

Resetting the base using the button on the base

As with resetting the base via the menu, all individual settings are reset. The **system PIN is also reset** to 0000 and **all handsets registered above and beyond the scope of delivery will be de-registered**.

Please note

For instructions on re-registering the handsets after a reset (where applicable)
→ [page 94](#).

- ▶ Remove the cable connections from the base to the router (→ [page 20](#)) and fixed line (→ [page 18](#)).
- ▶ Remove the base power adapter from the socket (→ [page 18](#)).
- ▶ **Press and hold** the registration/paging button (→ [page 8](#)).
- ▶ Plug the power adapter back into the power socket.
- ▶ Press and hold the registration/paging button (at least 10 seconds).
- ▶ Release the registration/paging button. The base has now been reset.

Checking the base MAC address

Depending on your network configuration, you may have to enter your base MAC address in your router's access control list, for example. You can check the MAC address on the handset.

In idle status:

Menu Open menu.

* 0 # -- 0... 5 # -- 2 # -- 0...

Press keys in sequence. The MAC address is displayed.

Back Return to idle status.

Connecting the base station to the PABX

The following settings are only necessary if your PABX requires them; see the PABX user manual.

You cannot send or receive SMS messages on PABXs that do not support Calling Line Identification.

Recall (fixed line)

Setting recall

Your phone is preset for operation on the main connection. For operation on a PABX, you may have to change this value. Please refer to the user guide for your PABX.

Menu ▶  **Settings** ▶ **Telephony** ▶ **Recall**



Select recall and press **OK** (☑ = set value). Possible values are: 80 ms, 100 ms, 120 ms, 180 ms, 250 ms, 300 ms, 400 ms, 600 ms, 800 ms.

Saving an access code (outside line code)

You can save two access codes: one for dialling via the fixed line and one for dialling via VoIP.

Prerequisite: You must enter an access code for external calls using your PABX, e.g., "0".

Menu ▶  **Settings** ▶ **Telephony** ▶ **Access Code**

▶ You can enter data in the following fields:

Access ext line with:

For dialling via the fixed line: enter or change the access code, max. three digits.

For:

Specify when the access code should be inserted for dialling via the fixed line:

Call Lists

The access code is put in front of numbers dialled from one of the following lists:

- The SMS list
- The accepted calls list
- The missed calls list

All Calls

The access code prefixes all numbers dialled.

Off

The access code for the fixed line is deactivated. It does not prefix any phone number.

Access IP line with:

For dialling via VoIP connections: Enter or change access code, max. 3 digits.

Connecting the base station to the PABX

For:

Specify when the access code should also be dialled when dialling via VoIP:

Call Lists

For dialling from the SMS list, missed calls list or accepted calls list.

All Calls

For all numbers dialled on the handset.

Off

No access code should be dialled first for calls via a VoIP connection.

OK Press the display key.

Please note

The access code never prefixes any emergency numbers or SMS service centre numbers.

Setting pauses

Changing the pause after line seizure

You can change the length of the pause that is inserted between pressing the talk key  and sending the number.

Menu Open main menu.



Press keys in sequence.



Enter number for the length of the pause (1 = 1 sec.; 2 = 3 secs; 3 = 7 secs) and press **OK**.

Changing the pause after recall key

You can change the length of the pause if your PABX requires this (refer to the user guide for your PABX).

Menu Open main menu.

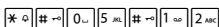

Press keys in sequence.



Enter a number for the length of the pause (1 = 800 ms; 2 = 1600 ms; 3 = 3200 ms) and press **OK**.

Changing a dialling pause (pause after access code)

Menu Open main menu.



Press keys in sequence.



Enter a digit for the length of the pause (1 = 1 sec.; 2 = 2 sec.; 3 = 3 sec.; 4 = 6 sec.) and press **OK**.

To insert a dialling pause: press and hold  for 2 seconds. A P appears in the display.

Switching temporarily to tone dialling (DTMF)

If your PABX still operates with pulse dialling (PD), but you need tone dialling for a connection (e.g., to listen to the network mailbox), you must switch to tone dialling for the call.

Prerequisite: You are conducting a call or have already dialled an external number.

Press the star key.

After the call ends, pulse dialling is automatically reactivated.

Configuring the phone via the Web configurator

The Web configurator for your Gigaset telephone enables you to change the settings for your phone conveniently on your PC.

- ◆ Alternatively, you can change settings that are also available on a registered Gigaset telephone handset via the Web browser on your PC, e.g., configuring VoIP connections, downloading firmware updates or starting Eco Mode.
- ◆ You can change additional settings that are not possible via a registered handset, e.g., meeting particular prerequisites for connecting the phone to a company network or adjusting the voice quality on VoIP connections.
- ◆ On the base, you can save data that is required to access specific services on the Internet. These services include access to public and private net directories, to the POP3 server for your e-mail account and synchronising the date/time with a time server.
- ◆ You can save configuration data for your telephone as files on your PC and reload these onto your telephone in the event of an error.
- ◆ You can manage the directories on registered Gigaset handsets (save to PC, compare them with one another or against a directory on your PC).

Below you will find a list of the Web configurator functions and the navigation paths to the Web configurator pages where the functions are available. See the online Help for the Web configurator (→ [page 123](#)) for a detailed description of the Web pages and the required entries.

Connecting the PC with the telephone's Web configurator

Prerequisites:

- ◆ A standard Web browser is installed on the PC, e.g., Internet Explorer version 7.0 or higher, Firefox version 3.5 or higher or Apple Safari version 3.x.
- ◆ The phone and PC are directly connected with each other via a router. The settings of any existing firewall installed on your PC allow the PC and phone to communicate with each other.

There are two ways of connecting your PC to the Web configurator of the phone:

- ◆ Via the phone's IP address in the local network;
- ◆ Via the Gigaset configuration service, if the phone and PC are connected to the Internet (→ [page 118](#)).

Please note

- ◆ Depending on your VoIP provider, it is possible that you will be unable to change individual settings in the Web configurator.
- ◆ The phone is **not** blocked while you select your settings in the Web configurator. You can make calls with your phone or modify settings at the same time.
- ◆ While you are connected to the Web configurator, it is blocked to other users. It cannot be accessed by more than one user at any one time.

Establishing a connection via the phone's IP address

- ▶ Determining a telephone's current IP address via one of the registered handsets: You can see the phone's current IP address in the handset display by **briefly** pressing the registration/paging button on the base. Your phone's IP address can change if you have activated dynamic IP address assignment (→ [page 106](#)).

Warning

If one of the four parts of the IP address contains leading zeros (e.g., 002), these zeros must not be entered in the Web browser address field. Otherwise, the Web browser will not be able to establish a connection to the Web configurator.

Example: The IP address 192.168.002.002 is displayed on the phone. 192.168.2.2 should be entered in the address field.

- ▶ Launch the Web browser on your PC.
- ▶ Enter **http://** and the telephone's current IP address (for example: http://192.168.2.2) into the address field of the Web browser.
- ▶ Press the return key.

A connection is established to the phone's Web configurator.

Establishing a connection via Gigaset config

Prerequisite: Your PC and phone are connected to the Internet.

- ▶ Launch the Web browser on your PC.
- ▶ Enter the following URL into the Web browser's address field:
<http://www.gigaset-config.com>
- ▶ Press the return key.

You will receive a message stating that the connection has been forwarded to your phone.

If several Gigaset phones can be reached via your Internet connection, you are asked which of these phones you would like to be connected to.

After successfully forwarding the connection, the Web configurator's **Login** page is displayed in the Web browser.

Please note

The connection between the PC and the Web configurator is a local connection (LAN connection). The Internet is only accessed to establish the connection.

Logging into/off the Web configurator

Prerequisite: Your PC and phone are connected to the Internet.

Logging in, setting the interface language

Once you have successfully established the connection, the **Login** Web page is displayed in the Web browser.

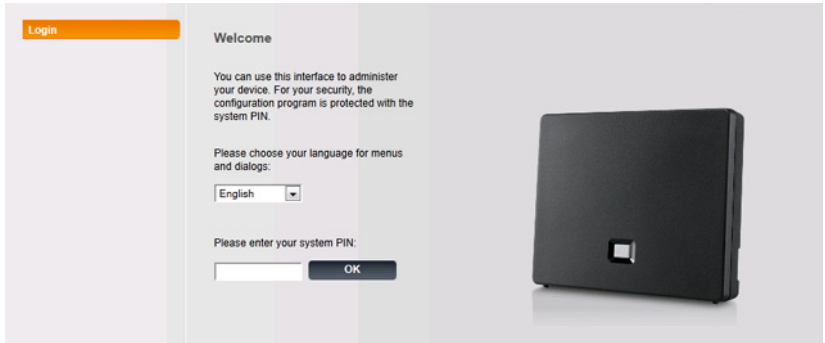

Figure 1 Start screen

You can select the language you want the menus and Web configurator dialogs to be displayed in. The language that is currently selected is displayed in the first field on the Web page.

- ▶ If necessary, click to open the list of available languages.
- ▶ Select the language.

The Web page is reloaded in the selected language. This may take some time, as the web pages for the Web configurator for the required language are loaded onto the base from the configuration server.

- ▶ Enter your phone's system PIN (default setting: 0000) in the bottom field of the Web page to access the Web configurator functions.
- ▶ Click **OK**.

Once you have successfully logged in, the **Home** Web page opens with general information on the Web configurator.

If you enter an incorrect system PIN, a corresponding message is displayed. You are prompted to re-enter the PIN.

If you enter an incorrect system PIN a second time, the PIN field is blocked for a short time (greyed out). The duration of the block will double each time a PIN is subsequently entered incorrectly.

Please note

- ◆ If the system PIN is still set as 0000 on the phone (default setting), you will be notified during login that the device is not secure and you should change the PIN. You can deactivate this security advice for subsequent logins by selecting the option "**Don't show this security advice again.**". Click **OK** to close the dialog box.
- ◆ If you do not make any entries for a lengthy period (approx. 10 minutes), you are automatically logged off. The next time you try to make an entry or open a Web page, the **Login** Web page is displayed. Re-enter the system PIN to log back in again.
- ◆ Any entries that you did not save on the phone before automatic log-off will be lost.

Logging off

In the menu bar (→ **page 121**) at the top right of every Web page in the Web configurator, you will see the **Log Off** command. Click **Log Off** to log off from the Web configurator.

Warning

Always use the **Log Off** command to end the connection to the Web configurator. If, for example, you close the Web browser without logging off beforehand, access to the Web configurator may be blocked for a few minutes.

Understanding the structure of the Web configurator pages

The Web configurator pages (Web pages) contain the UI elements shown in **Figure 2** (example).

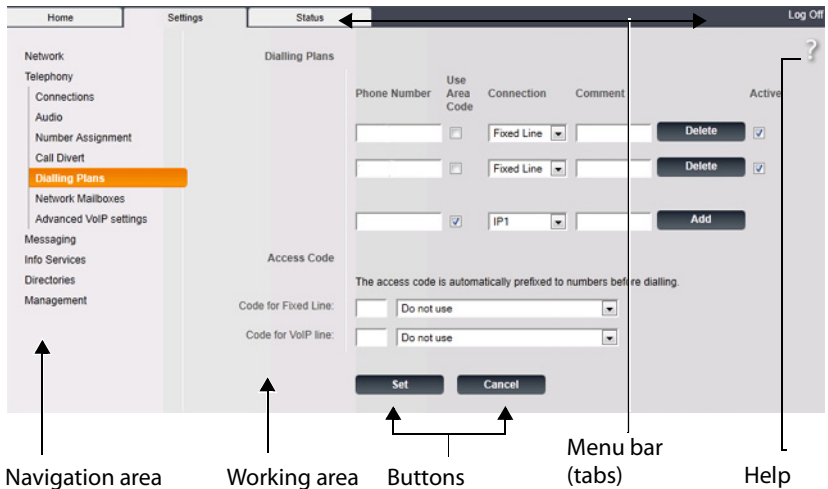

Figure 2 Example of the structure of a Web configurator page

Menu bar

The Web configurator menus are displayed in the form of tab pages in the menu bar.

The following menus are available:

Home

The home page opens once you have logged in to the Web configurator. It contains information on the Web configurator functions.

If no VoIP connection is configured on your phone yet, from the home page you can start a wizard that supports you in configuring new VoIP connections. To do this, click **Quick Start Wizard**.

Settings

This menu allows you to make settings on your phone.

If you select the **Settings** menu, a list containing this menu's functions is displayed in the navigation area (→ **page 122**).

Status

This menu provides you with information about your phone and its connections.

Log Off

You will find the **Log Off** function to the right of the menu bar on every Web page.

Please note

For an overview of the Web configurator menus, see → [page 125](#).

Navigation area

The functions of the menu (→ [page 121](#)) selected in the menu bar are listed in the navigation area.

If you select a function, the associated page containing information and/or input fields opens in the working area. The selected function is highlighted in orange.

If a function is assigned subfunctions, these are listed below the function as soon as you select the function (in the example **Telephony**).

The relevant page for the first subfunction (highlighted in orange) is displayed in the working area.

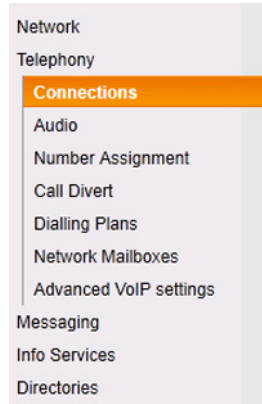

Working area

Depending on the function selected in the navigation area, information or dialog boxes are displayed in the working area that allow you to make or change your phone settings.

Making changes

Make settings via input fields, lists or options.

- ◆ There may be restrictions regarding the possible values for a field e.g., the maximum number of characters, entering special characters or certain value ranges.
- ◆ To open a list, click the button. You can choose between default values.
- ◆ There are two kinds of options:
 - Checkboxes: You can activate one or more options from a list. Active options are indicated by , non-active options by . You can activate an option by clicking . The status of the other options in the list does not change. You can deactivate an option by clicking .
 - Alternative options (radio buttons): The active option in the list is indicated by , and the non-active by . You can activate an option by clicking . The previously activated option is deactivated. You can only deactivate an option by activating another option.

Entering Cyrillic and Turkish characters

In the following section, the specified maximum number of characters permitted in a field refers to Latin characters and digits (1 character = 1 byte), i.e., 1 character means 1 byte.

Cyrillic and Turkish characters require 2 bytes each, e.g., with a field length of 16 characters, you can enter a maximum of eight Cyrillic or Turkish characters.

If you enter too many characters into a field, the entry is rejected (not saved in the phone). The "old" field content (or the default settings) is retained and displayed again when the Web page is updated. No warning/confirmation is given.

Applying changes

As soon as you have made your change on a page, save and activate the new setting on the phone by selecting **Set**.

If your entry does not comply with the rules for this field, an appropriate error message is displayed. You can then repeat the input.

Warning

Changes that have not been saved on your phone are lost if you move to another Web page or the connection to the Web configurator is lost, e.g., due to exceeding the time limit (→ [page 120](#)).

Buttons

Buttons are displayed in the bottom section of the working area. Depending on the current function of a Web page, various buttons are displayed. The functions of these buttons are described in the online Help of the Web configurator. The most important buttons are:

Cancel

Reject changes made on the Web page and reload the settings that are currently saved in your phone to the Web page.

Set

Store changes made on a Web page on the phone.

Help

You will see a question mark at the top right of most Web pages. Click this question mark to open the online Help for this Web page in a separate window.

The Help pages are downloaded directly from the configuration server.

Please note

You may need to change your browser settings to display the Help pages correctly. Internet Explorer and Firefox require the following settings, for example:

- ▶ You must allow blocked active content for Help (right-click the information bar at the top of the browser window).
- ▶ Allow the pages to use their own fonts or set Arial as the standard font (general option).

Means of representation in Help

Bold font

User interface terms such as menu functions, names of input fields and options.

[Bold font]

Buttons.

[About this Help ▶ / About this Help ▼](#)

Blue, underlined text shows hidden text.

Click this link once to show the hidden text. The arrow at the end of the link rotates by 90°.

Click [About this Help ▼](#) to hide the text again.

Telephony > Dialling Plans

Navigation to a Web configurator function.

Matches the illustration "**Telephony ▶ Dialling Plans**" in this user manual (→ **Opening Web pages** below)

Searching in Help

Click inside the Help window and press the **Ctrl** and **F** keys. A search dialog opens.

Opening Web pages

A brief outline of how to navigate to the individual Web configurator functions is given below.

Example

Defining dialling plans:

Settings ▶ Telephony ▶ Dialling Plans

To open the Web page, proceed as follows after login:

- ▶ Select the **Settings** menu in the menu bar.
- ▶ Click the **Telephony** function in the navigation area.
The **Telephony** subfunctions are displayed in the navigation tree.
- ▶ Select the **Dialling Plans** subfunction.

Web configurator menu

Home			
Settings	Network	IP Configuration	→ page 126
		Security	→ page 127
	Telephony	Connections	→ page 128
		Audio	→ page 130
		Number Assignment	→ page 131
		Call Divert	→ page 134
		Dialling Plans	→ page 132
		Network Mailboxes	→ page 134
		Advanced VoIP Settings	→ page 134
	Messaging	E-Mail	→ page 136
		MWI Light	→ page 138
	Info Services		→ page 136
	Directories	Online Directory	→ page 136
		Directory Transfer	→ page 137
	Management	Date & Time	→ page 136
		Local Settings	→ page 138
		Miscellaneous	→ page 140
		Reboot & Reset	→ page 139
Save & Restore		→ page 139	
Firmware Update		→ page 140	
Status	Device		→ page 141
	Connections		

Functions of the Web configurator

Connecting the base to the local network (LAN/router)

You can find the functions for connecting to the LAN on the Web page:

Settings ▶ Network ▶ IP Configuration

In most cases, special settings are not required to connect the phone to the router/ a local network. Your phone is preconfigured for dynamic assignment of the IP address by default (DHCP). In order for your router to "recognise" the phone, dynamic IP address assignment must also be activated on the router, i.e., the router's DHCP server must be activated.

If the DHCP server cannot or should not be activated, you must assign a fixed/static IP address to the phone (→ [page 106](#)). A fixed IP address is useful, for example, if port forwarding or a DMZ is set up on the router for the phone.

You can also assign a static IP address via a handset.

You can also use the Web configurator to make further settings that are required if you connect your phone to a large (company-wide or organisation-wide) network, or if you want to manage the phone remotely using the Web configurator. You can:

- ◆ Specify the address of a HTTP proxy server within the LAN that the phone can use to establish connections to the Internet if direct access is not allowed in the LAN.
- ◆ Store **VLAN Identifier/VLAN Priority** for access to a tagged VLAN.
- ◆ Allow PCs outside your LAN to connect to the Web configurator.

Warning

- ◆ Authorising access from other networks increases the risk of unauthorised access. It is therefore recommended that you disable remote access if you no longer require it.
- ◆ The Web configurator can only be accessed from other networks if your router passes on the service requests from "outside" to port 80 (the default port) of the phone. Make sure you read the user manual for your router.

Making security settings – managing certificates for TLS authentication

The phone supports the establishment of secure data connections on the Internet with the TLS security protocol (Transport Layer Security). With TLS, the client (the phone) uses certificates to identify the server. These certificates must be stored on the base.

You can manage TLS certificates using the Web page:

Settings ▶ Network ▶ Security

This page contains the **Server Certificates/CA Certificates** lists. They contain the certificates saved in the base. The certificates have either already been saved on the base by default, or you have downloaded them to your base via the **Security Web** page.

The **Invalid Certificates** list contains the certificates received from servers that have not passed the certificate check when establishing a connection, and certificates from the **Server Certificates/CA Certificates** lists that have become invalid (e.g., because they have expired).

You can remove certificates and download new certificates to the base, and you can also accept or reject invalid certificates.

If the connection to a data server on the Internet is not made because the phone does not accept the certificate received from the server (e.g., when downloading your e-mail messages from the POP3 server), you will be prompted to open the **Security Web** page.

The **Invalid Certificates** list contains the certificate used to make the connection. You can display information on the certificate by marking it and clicking on the **[Details]** button. This information includes who issued the certificate (certification authority) and who for, as well as its validity period.

You must use the information to decide whether to accept or reject the certificate.

If you accept the certificate, depending on its type, it is transferred to one of the **Server Certificates/CA Certificates** lists (even if it has already expired). If a server responds again with this certificate, this connection is accepted immediately.

If you decline the certificate, it is transferred to the **Server Certificates** list with the label (**rejected**). If a server responds again with this certificate, this connection is rejected immediately.

Managing base connections; activating/deactivating connections

You can manage your base connections using the Web page:

Settings ▶ Telephony ▶ Connections

This Web page displays a list with all possible connections and your status (e.g., connected, registered):

◆ Fixed Line Connection

You do not have to configure the fixed line connection. You can make or receive calls on the fixed line connection once your phone is connected to the fixed line connection.

You can change the name of the fixed line connection and the setting for the **Dialling mode** and **Recall** by clicking the corresponding **[Edit]** button.

The name entered is shown, e.g., for calls to your fixed line connections, in the display of the registered handsets and in the call list.

The recall is set by default for operating the phone on the main connection. You must change it if necessary if you connect the phone to a PABX (see the user guide for your PABX). The flash time specifies the duration of the line interruption used to send control signals to the exchange or the telecommunications system (call transfer, setting up a consultation call etc.).

◆ Gigaset.net

The Gigaset.net connection is preconfigured in your phone. Your phone is pre-assigned a Gigaset.net number.

You can activate and deactivate the Gigaset.net connection. If the connection is deactivated, the phone will not register with the Gigaset.net service. You are then not available via the Gigaset.net connection.

Click the corresponding **[Edit]** button to change the name of the Gigaset.net connection and deactivate STUN.

The Gigaset.net connection uses a STUN server as standard. In the sent data packets, Gigaset.net replaces the private IP address of your phone with its public IP address.

If you operate your phone behind a router with symmetric NAT, STUN cannot be used. You must deactivate it. Otherwise, when making Gigaset.net calls you will not be able to hear the caller.

◆ IP Connection

You can assign up to six VoIP connections (VoIP phone numbers) to your phone. You need to set up a VoIP account with a VoIP provider for each VoIP phone number. You must save the access data for each account and for the relevant VoIP provider in the phone.

A list entry is available for each VoIP connection; this is used to configure and manage the connection.

To do this, click on the corresponding **[Edit]** button.

Configuring/deleting VoIP connections

To configure and delete VoIP connections, open the Web page

Settings ▶ Telephony ▶ Connections

Click on the [Edit] button next to the list entry for the VoIP connection.

This opens a Web page with the following areas:

- ◆ **VoIP Configuration / Profile Download**
- ◆ **Personal Provider Data**
- ◆ **General data of your service provider**
- ◆ **Network data for your service provider**

For detailed information on the areas, see the online Help for this web page. Open the online Help by clicking on the  question mark (at the top right of the web page).

There are various ways of configuring a VoIP connection:

- ◆ Some providers support auto configuration with an auto configuration code. In this case, you merely have to start the configuration assistant (**Start Configuration Assistant** button). It prompts you to enter the configuration code. All the required VoIP data is then downloaded into the areas specified above. The configuration is complete.
- ◆ Most providers supply provider profiles with the general provider data on the configuration server. You can use the configuration assistant to load them to your phone. To do this, click on the **Start Configuration Assistant** button. The assistant prompts you to select your country and the provider. It then loads the provider profile data to the areas **General data of your service provider** and **Network data for your service provider**.

You then have to transfer your personal account data to the assistant.

In exceptional cases, you also have to adjust the settings in the **Network data for your service provider** area to suit the settings for your router:

- If you cannot hear the caller on an outgoing call, you may have to switch between outbound proxy server mode and STUN use. In the sent data packets, the STUN or outbound server replaces the private IP address of your phone with its public IP address. If you operate your phone behind a router with symmetric NAT, STUN cannot be used.
- If you are sometimes unavailable for incoming calls, you may have to adjust the value in **NAT refresh time**:
If you have not activated port forwarding or set up a DMZ on the router for the phone, an entry in the routing table for the NAT (in the router) is required to make the phone available. The phone must confirm this entry in the routing table at certain intervals (**NAT refresh time**) so that the entry stays in the routing table.
- ◆ There is no provider profile for your provider.
If this is the case, you must change the settings in the **Personal Provider Data**, **General data of your service provider** and **Network data for your service provider** areas yourself. Your VoIP provider will supply you with this data.

Activating/deactivating automatic check for provider profile updates, updating profiles

To activate/deactivate the check or start the search, open the web page

Settings ▶ Telephony ▶ Connections

You have the following options:

◆ **Activate/deactivate automatic check**

With the **Automatic check for profile updates** option, you can activate/deactivate the check for profile updates.

If the version check is activated, the phone checks daily whether new versions of the provider profiles, with general provider data, are available for the providers for your VoIP connections.

If a new version of a provider profile is available, a message to this effect is shown on the display of the registered handsets. You can start the update on one of the handsets (→ [page 109](#)).

Please note

If the telephone is not connected to the Internet at the time when the check is to be performed (e.g., because the router is disabled), the check is performed as soon as the phone is reconnected to the Internet.

◆ **Update provider profiles**

To update the provider profiles directly, click **Update Profile**. The phone then checks, for all profiles loaded, whether updates are available. Where applicable you can then load the updates to your phone.

Optimising voice quality for VoIP connections

Functions to improve the voice quality on VoIP connections are available on the Web page:

Settings ▶ Telephony ▶ Audio

The voice quality for VoIP connections is mainly determined by the **voice codec** used for transferring the data and the available **bandwidth** of your DSL connection. In the case of the voice codec, the voice data is digitised (coded/decoded) and compressed. A "better" codec (better voice quality) means more data needs to be transferred, i.e., perfect voice data transfer requires a DSL connection with a larger bandwidth.

You can change the voice quality by selecting (bearing in mind the bandwidth of your DSL connection) the voice codecs your phone is to use, and specifying the order in which the codecs are to be suggested when a VoIP connection is established.

Default settings for the codecs used are stored in your phone; one setting optimised for low bandwidths and one for high bandwidths.

You can generally select one of these standard settings for all VoIP connections on your phone. If your DSL connection has a low bandwidth, you can also exclude parallel VoIP connection to increase the voice quality.

You can also change the settings for the voice codecs yourself by selecting the voice codecs to be used for each VoIP connection on your phone and specifying the sequence in which they should be suggested when establishing a VoIP connection.

The following voice codecs are supported by your phone:

G.722

Excellent voice quality. The **broadband** speech codec **G.722** works at the same bit rate as G.711 (64 kbit/s per speech connection) but with a higher sampling rate. This allows higher frequencies to be played back. The speech tone is therefore clearer and better than for the other codecs (High Definition Sound Performance).

G.711 a law / G.711 μ law

Excellent voice quality (comparable with ISDN). The necessary bandwidth is 64 kbit/s per voice connection.

G.726

Good voice quality (inferior to that with G.711 but better than with G.729).

Your phone supports G.726 with a transmission rate of 32 kbit/s per voice connection.

G.729

Average voice quality. The necessary bandwidth is less than or equal to 8 kbit/s per voice connection.

To save additional bandwidth and transmission capacity, on VoIP connections that use the **G.729** codec you can suppress the transmission of voice packets in pauses ("silence suppression"). Instead of the background noises in your environment, your caller then hears a synthetic noise generated in the receiver (option: **Enable Annex B for codec G.729**).

Please note

Observe the following for good voice quality:

- ◆ When making calls using VoIP, avoid performing other Internet activities (e.g., surfing the Internet).
- ◆ Please note that voice delays can occur depending on the codec used and the network capacity utilisation.

Assigning send and receive connections

For the number assignment, open the Web page:

Settings ▶ Telephony ▶ Number Assignment

Assign send and receive connections to the registered handsets.

Please note:

- ◆ During registration, each handset is automatically assigned the fixed line connection as a send connection and all base connections as receive connections.
- ◆ You can assign each handset either a fixed send connection or a line selection. With line selection, you choose the connection to be used for each call.
- ◆ The Gigaset.net number is fixed as the send connection for each registered handset. Numbers that end in #9 are automatically dialled via Gigaset.net.

Please note

You can override the assignment of the send connection for certain phone numbers by defining dialling plans for these numbers.

Activating the fixed line connection as the fallback send connection.

You can activate the fixed line connection on your phone as a fallback connection. If a call attempt fails via VoIP, an attempt is automatically made (without prompting) to establish a connection via the fixed line.

A fallback is used in the following situations:

- ◆ Your VoIP connections are busy
- ◆ The phone is not connected to the Internet (e.g., no direct connection to router/switch or incorrect IP configuration).

Exception

SMS messages that are to be sent via a VoIP connection are **not** sent via the fallback connection.

The option to activate the fallback connection is on the Web page:

Settings ▶ Telephony ▶ Number Assignment

Defining settings for the call manager on the PC

Specify the VoIP connection and handset to be used for a call selected on the PC.

The options are on the Web page:

Settings ▶ Telephony ▶ Number Assignment

User-defined dialling plans – specifying rules for telephony

You can define your own dialling plans in the **Dialling Plans** area on the Web page:

Settings ▶ Telephony ▶ Dialling Plans

You can specify the following dialling plans:

- ◆ You can define a connection (fixed line or a VoIP connection) for specific phone numbers that are always used to dial these phone numbers and therefore for billing.
If you enter just a few digits (e.g., local area, national or mobile network code) any call to a number beginning with these digits will be made via the selected connection.
- ◆ If you block specific phone numbers, your phone will not establish any VoIP connections to these numbers (e.g., 0190 or 0900 numbers).

These dialling plans apply to all registered handsets. The send connection settings are inactive when you dial numbers that are governed by a dialling plan.

You can activate and deactivate the dialling plans as required.

Please note

Dialling plans are not effective if you have assigned the line selection to a display key on the handset and you explicitly choose a send connection from the list of available connections before dialling. However, if a block is set in the dialling plan, this takes effect for VoIP connections (but not fixed line connections).

Tips:

- ◆ Compare the rates for long-distance calls (especially for international calls) offered by your fixed line and VoIP providers, and determine which connection should be used specifically for these countries/locations, e.g., a dialling plan for the **Phone Number** "0033" would apply to every call made to France.
- ◆ Use dialling plans to define that numbers starting with a call-by-call number are always made via your fixed line connection. To do so, enter the call-by-call number in the **Phone Number** field.

Please note

If dialling plans overlap, the one with the greatest concordance will apply.

Examples:

There is a dialling plan for the number "02" and one for the number "023". If you dial "0231..." the second plan will apply; if you dial "0208..." the first plan will apply.

Examples

All calls to the mobile phone network should be made via your VoIP connection with provider B. The mobile phone network numbers start with 017, 015 and 016.

Dialling plans:

Phone Number = 017 **Connection** = IP3, provider B

and the corresponding dialling plans for "015" and "016".

Emergency numbers

If no emergency numbers are set by default, you should define dialling plans for emergency numbers yourself and assign them to a connection that you know supports emergency calls.

Access codes – activating dialling plans when connecting to a PABX

If your phone is connected to a PABX, you may have to enter an access code for external calls (outside line code, e.g., "0").

Save one access code each for fixed line and VoIP connections and specify separately for VoIP and fixed line connections when the phone numbers should be automatically prefixed with the digits.

You can choose between **Use always**, **Do not use** and **Use for call lists** (only when dialling from the calls list).

These settings are available in the **Access Code** area on the Web page:

Settings ▶ Telephony ▶ Dialling Plans

Entering the network mailbox, enabling/disabling the network mailbox

A list of the network mailboxes for all connections on your phone is available on the Web page:

Settings ▶ Telephony ▶ Network Mailboxes

You can enter the phone numbers for the network mailboxes in this list.

You can use this list to activate/deactivate the network mailboxes for all configured VoIP connections.

Making special settings for VoIP telephony

Activating call divert (call forwarding) for VoIP connections

The settings for call divert are on the Web page:

Settings ▶ Telephony ▶ Call Divert

You can divert calls to your VoIP connections and to your Gigaset.net number.

You can divert calls to your VoIP connections to any external number (VoIP, fixed line or mobile number). Call divert takes place via VoIP.

You can divert calls to your Gigaset.net number within the Gigaset.net, i.e., to another Gigaset.net number.

For each of your VoIP connections (VoIP accounts), you can determine if and when calls to the corresponding VoIP number should be diverted to a different VoIP phone number.

Setting DTMF signalling for VoIP

You can change the settings for DTMF signalling in the **DTMF over VoIP connections** area on the Web page:

Settings ▶ Telephony ▶ Advanced VoIP Settings

DTMF signalling is required, for example, for querying and controlling certain network mailboxes via digit codes or for remote operation of an answering machine.

To send DTMF signals via VoIP you must first define how key codes should be converted into and sent as DTMF signals: as audible information via the speech channel or as an "SIP Info" message. Ask your VoIP provider which type of DTMF transmission it supports.

You can configure your telephone in such a way that it attempts with each call to set the most suitable DTMF signalling for the current codec (**Automatic**).

Or you can explicitly define the type of DTMF signalling:

- ◆ **Audio** or **RFC 2833** if DTMF signals are to be transmitted acoustically (in voice packets).
- ◆ **SIP Info** if DTMF signals are to be transmitted as code.

Please note

- ◆ The settings for DTMF signalling apply to all VoIP connections (VoIP accounts).
- ◆ DTMF signals cannot be transmitted in the audio path (**Audio**) on broadband connections (the G.722 codec is used).

Configuring call transfer via VoIP

You can change the settings for call transfer in the **Call Transfer** area on the Web page:

Settings ▶ Telephony ▶ Advanced VoIP Settings

You can connect an external call to one of your VoIP connections with a second external participant (depending on the provider). You do this by establishing an external consultation call to the second participant and pressing the R key on the handset once you have registered the second participant. The call is transferred.

You can expand or change the settings for call transfer as follows:

- ◆ You can activate call transfer by ending the call. The two external participants are connected with one another when you press the end call key  on the handset. Your connections with the participants are terminated.
- ◆ You can activate direct call transfer. You can then transfer the call before the second participant has answered.
- ◆ You can deactivate call transfer with the R key if you want to assign a different feature to the R key (→ "**Defining R key functions for VoIP (hook flash)**").

Defining R key functions for VoIP (hook flash)

You can specify the function for the R key on the Web page:

Settings ▶ Telephony ▶ Advanced VoIP Settings

Your VoIP provider may support special performance features. To make use of these features, your phone needs to send a specific signal (datapacket) to the SIP server. You can assign this "signal" as the R function to the R key of the handsets. **Prerequisite:** The R key is not used for call divert (default setting, see above).

If you press this key during a VoIP call, the signal is sent. This requires that DTMF signalling via SIP info messages is activated on the phone (see above).

Defining local communication ports for VoIP

The settings for the communication ports are on the Web page:

Settings ▶ Telephony ▶ Advanced VoIP Settings

The following communication ports are used for VoIP telephony:

◆ SIP port

The communication port via which the phone receives (SIP) signalling data. The default standard port number is set to 5060 for SIP signalling.

◆ RTP port

Two consecutive RTP ports (consecutive port numbers) are required for each VoIP connection. Voice data is received via one port and control data via the other. The default standard port number is set to 5004 for voice transmission.

Configuring the phone via the Web configurator

This setting only has to be changed if the port numbers are already being used by other subscribers in the LAN. You can then specify other fixed port numbers or port number ranges for the SIP and RTP port.

If several VoIP phones are operated on the same router with NAT, it makes sense to use randomly selected ports. The phones must then use different ports so that the router's NAT is only able to forward incoming calls and voice data to one (the intended) phone. Use the Web configurator to specify a port number range for the SIP and RTP port that the ports are chosen from.

Making settings for access to Internet services

You can use the following Internet services on your phone.

◆ E-mail notifications

In order to use the e-mail function of your base, you have to save the address of the POP3 server and your personal access data for your mailbox in the base.

You can save the access data for up to six e-mail accounts on your base and assign the related incoming message lists to the individual handsets registered.

You can also specify the time interval at which your phone should check whether the POP3 servers have received new e-mail messages and specify whether authentication on the POP3 server should be performed via a secure connection.

You can change the settings on the Web page:

Settings ▶ Messaging ▶ E-Mail

◆ Customising info services

You can customise your personal services for the screensaver **Live Ticker** on the handset on the Gigaset.net Web portal. You can access the Gigaset.net Web portal (URL and personal access data) on the Web configurator page:

Settings ▶ Info Services

◆ Online directories

From the list of available online directories, select those that you want to use on the registered handsets.

You can change the settings on the Web page:

Settings ▶ Directories ▶ Online Directory

◆ Managing the synchronisation of the base with a time server

By default, your phone is configured so that the date/time is transferred from a time server on the Internet.

Changes to the settings for the time server and activation/deactivation of the synchronisation are done via the Web page:

Settings ▶ Management ▶ Date & Time

Deleting handset directories and downloading to/from the PC

You will find the functions for editing the telephone/address books (both referred to as "directories" hereafter) on the website:

Settings ▶ Directories ▶ Directory Transfer

The Web configurator has the following options for editing the directories of the registered handsets.

- ◆ Store the directories on a PC. Entries are stored in vCard format in a vcf file on the PC. You can download these files onto every registered handset. You can also copy directory entries to your PC address book.
- ◆ Copy contact details from your PC address book to handset directories. Export the contacts in vcf files (vCards) and transfer them to directories for the handsets using the Web configurator.
- ◆ Delete the directory on the handset.
If you have edited the directory file (vcf file) on the PC and would like to load this modified directory to the handset, you can delete the current directory on the handset before the transfer.

Tip: Back up the current directory on your PC before deleting it. You can then reload it if the modified directory is affected by formatting errors and some, or all, of it cannot be loaded onto the handset.

Please note

- ◆ You can find information on vCard format (vcf) on the Internet, e.g., at:
www.en.wikipedia.org/wiki/VCard (English) or
www.de.wikipedia.org/wiki/VCard (German)
(You can set the display language at the bottom left-hand side in the navigation area of the Web page.)
- ◆ If you wish to copy a directory (vcf file) with multiple entries stored on the PC to the Microsoft Outlook™ directory, please proceed as follows:
Microsoft Outlook™ only ever transfers the first (directory) entry from the vcf file to its address book.

Transfer rules

The directory entries from a vcf file that are loaded onto the handset will be added to the directory. If an entry already exists for a name, it will either be supplemented or a new entry for the name will be created. The process will not overwrite or delete any phone numbers.

Please note

Depending on your device type, up to three entries with the same name are created in the directory for each vCard – one entry per entered number.

Directory file content (vcf file)

The following data (if available) is written into the vcf file for entry into the directory or transferred from a vcf file into the handset directory:

- ◆ Name
- ◆ First name
- ◆ Number
- ◆ Number (office)
- ◆ Number (mobile)
- ◆ E-mail address
- ◆ Birthday (YYYY-MM-DD) and time of the reminder call (HH:MM) separated by a "T" (example: 2008-12-24T11:00)

Other information that a vCard may contain is not entered into the handset directory.

Example of an entry in vCard format:

```
BEGIN:VCARD
VERSION:2.1
N:Smith;Anna
TEL;HOME:1234567890
TEL;WORK:0299123456
TEL;CELL:0175987654321
E-MAIL:anna@smith.com
BDAY:2008-12-24T11:00
END:VCARD
```

Activating/deactivating the display of new messages with the flashing message key

For each handset, you can define the type of new messages for which the LED of the message key  should flash.

You can activate/deactivate the flashing of the message key for the following message types separately:

Missed calls, SMS, E-Mail, Network Mailboxes.

You can change the settings on the Web page:

Settings ▶ **Messaging** ▶ **MWI Light**

Making country-/location-specific basic settings, entering the area code

If you use VoIP to make a call to the fixed line, you may also have to dial the area code for local calls (depending on the provider). You can avoid having to dial your own area code by:

- ◆ Entering the complete area code (with international code) in the telephone configuration for the location in which you are using the phone and
- ◆ Defining per option that the local area code is automatically prefixed to every number dialled that does not start with 0 (even for numbers from a list or the directory).

These settings are on the Web page:

Settings ▶ Management ▶ Local Settings

Saving and restoring system settings

Once you have configured your base and after each configuration change, you can save the current base settings in a file on the PC (suffix .cfg).

If you change the settings accidentally or you need to reset the base due to a fault (base reset), you can reload the saved settings from the file on your PC to your phone.

The contents of the .cfg file include:

- ◆ The settings for the local network (IP configuration)
- ◆ The data for the (VoIP) connections established
- ◆ The assignment of send and receive connections
- ◆ Access code
- ◆ The network mailbox number
- ◆ The Internet services settings
- ◆ The ECO DECT settings

You can save and restore the system settings via the Web page:

Settings ▶ Management ▶ Save & Restore

Resetting the base station and resetting all device settings

- ◆ If your phone suddenly does not work as expected, you can restart it. This frequently resolves problems.
- ◆ You can also reset all of the settings on the phone to the default settings without disconnecting it from the mains power supply, e.g., if you give your phone to a third party or if you have forgotten your system PIN. All individual settings on the base station are reset to the default settings, including the system PIN, and all handsets registered beyond the delivery scope are deregistered.

If you have reset the base due to an error or forgotten system PIN, you can, where applicable, reload settings (→ [page 139](#)) saved on the PC to the base.

You can start the restart and reset via the Web page

Settings ▶ Management ▶ Reboot & Reset

Changing the base settings, registering handsets

You can use the Web configurator to:

- ◆ Switch the base to registration mode to register handsets to the base. This setting corresponds to pressing and holding the registration/paging button on the front of the base.
- ◆ Activate/deactivate Eco Mode or Eco Mode+. For Eco Mode see [page 91](#).
- ◆ Change the system PIN (→ [page 105](#)) for your phone.
- ◆ Activate and deactivate the LED for the registration/paging button on the front of the base. See [page 8](#) for the meaning of the LED.
- ◆ Activate/deactivate the display of VoIP status messages on your handset.

The base settings are on the Web page

Settings ▶ Management ▶ Miscellaneous

Updating firmware for the base/restoring firmware updates, activating/deactivating automatic updates

You can start firmware updates and downgrades via the Web page:

Settings ▶ Management ▶ Firmware Update

Regular updates to the base firmware and the provider profile for your VoIP connections (general provider data) are made available on an Internet configuration server. You can download these updates onto your base as required. The URL for this server is stored in the base.

You have the following options:

- ◆ Starting a firmware update

If a **new** version of the firmware is available, this is downloaded to the base and the base is restarted. A firmware update lasts around six minutes. The duration also depends on the bandwidth of your DSL connection.

- ◆ Enabling/disabling the automatic version check

When the version check is enabled, the phone checks on a daily basis whether the Gigaset configuration server has a new version of the phone firmware.

If the telephone is not connected to the Internet at the time when the check is to be performed (e.g., because the router is disabled), the check is performed as soon as the phone is reconnected to the Internet.

If a new version is available, a message to this effect is shown on the display of the registered handsets. You can start the update of the firmware on one of the handsets.

- ◆ Downgrading firmware

You have the following options:

- You can reload the firmware version that was loaded before the last update on the base.
- You can reload the firmware version that was loaded by default onto the phone.

The selected firmware is reloaded onto the phone and the current firmware is overwritten.

Displaying the status of the phone and its connections

The **Status** tab displays, for example, the following information.

Status ▶ Device

- ◆ IP and MAC address for the base

- ◆ Version of the firmware currently loaded

The version is shown in the following format: aabbxxyyyz

aa denotes the phone's product variant

bbb is the version of the firmware and xx the sub-version (yyyz are only significant for the service)

Edition 420200000 means that version 20 of the firmware is currently loaded on your base.

- ◆ A list of the registered handsets

Status ▶ Connections

The following is displayed for every connection on your phone:

- ◆ Connection Type (fixed line, VoIP, Gigaset.net)
- ◆ Name of the connection
- ◆ Status of the connection (registered, connected, etc.)
- ◆ Status of call transfer

Customer Service & Assistance

Do you have any questions? As a Gigaset customer, you can find help quickly in this User Manual and in the service section of our Gigaset online portal www.gigaset.com/service.

Please register your phone online right after purchase.

This enables us to provide you with even better service regarding questions or a warranty claim. In order to contact our customer service via email, please use the email contact form from our Gigaset online portal after selecting your home country.

Our representatives are also available on the telephone hotlines for consultation.

Australia	1 300 780 878	posta mentre per le chiamate effettuate attraverso la rete di altri operatori fissi o mobili consultate le tariffe del vostro operatore)
Austria	0043 1 311 3046	Jordan
Bahrain	97 31 73 11 173	00962 6 5625460/1/2
Belgium	0 78 15 66 79	Kuwait
Bosnia Herzegovina	033 276 649	+965 -22458737/22458738
Brazil	4003 3020	Lebanon
(grandes cidades e regiões metropolitanas - Custos de uma ligação local)	0800 888 3020	+9611240259/
(demais localidades - Gratuito)		+9611236110
Bulgaria	+359 2 9710666	Luxembourg
(0,50 евро на минута от всички държави за стационарни телефони. За обаждания от мобилни телефони може да има други цени).		+352 8002 3811
Canada	1-866 247-8758	Malaysia
China	0 21 400 670 6007 (RMB 0.11)	+603-8076 9696
Croatia	01 2456 555 (0,23 Kn)	Malta
Czech Republic	0 233 032 727	+390 2360 46789 (0,10 €)
Denmark	+45 (0) 35 25 86 00	Mexico
Finland	09 231 134 25	... 01800 999 4442738 (01800 999 GIGASET)
France	+33 170 706 181	Netherlands
Coût d'un appel local depuis une ligne fixe		0900-3333102
France Télécom.		(0,25 € per minuut (vast net). Voor oproepen uit het mobiele netwerk kunnen andere prijzen gelden.)
Germany	01805 333 222	New Zealand
Der Anruf kostet Sie aus den deutschen Festnetzen 0,14 € pro Minute. Anrufe aus den deutschen Mobilfunknetzen kosten höchstens 0,42 € pro Minute.		0800 780 878
Greece	801-100.0.500	Norway
(Χρέωση 0,0026 € το λεπτό για το σταθερό δίκτυο της Ελλάδας. Για κλήσεις από κινητό ίσως ισχύουν άλλες χρεώσεις)		22 70 84 00
Hong Kong	2763 0203	(Oppstartskost 89 øre + 15 øre pr minutt fra fasttelefon. For samtaler fra mobil vil det gjelde egne priser.)
.....	2389 7285	Oman
Hungary	01 267 21 09 (27 Ft)	+968 709281 Ext. 49/21/75
India	Please refer to your local warranty card	Poland
Indonesia	(62-21) 5673813	801 140 160
.....	(62-21) 888856000	Portugal
Ireland	18 50 77 72 77	(351) 808 781 223
Italy	199.15.11.15	(custo de uma chamada local)
(€ cent 8,36 + IVA al minuto da telefono fisso della rete Telecom Italia senza scatto alla ris-		Romania
		+40 021 204 9130
		Russia
		8 (495) 2281312
		Serbia
		0800 222 111
		Singapore
		6735 9100
		Slovak Republic
		02 59 68 22 66 (4,428 sk)
		Slovenija
		01 5644171
		South Africa
		+2711 46 13 181
		Spain
		902 103935
		Sweden
		87 50 99 11
		Switzerland
		0848 212 000
		Taiwan
		02 266 24343
		Turkey
		0216 459 98 59
		Ukraine
		+380-44-451-71-72
		United Arab Emirates
		+97144458255/
		+97144458254
		United Kingdom
		0 84 53 67 08 12
		USA
		1-866 247-8758
		Vietnam
		1 900 545 416

For questions about VoIP access, please contact the respective service provider.

Please have your record of purchase ready when calling.

Replacement or repair services are not offered in countries where our product is not sold by authorised dealers.

Questions and answers

If you have any queries about the use of your telephone, visit our website at www.gigaset.com/service for assistance 24/7.

The table below also lists steps for troubleshooting.

<p>The display is blank.</p> <ol style="list-style-type: none">1. The handset is not activated.<ul style="list-style-type: none">▶ Press and hold the end call key .2. The battery is empty.<ul style="list-style-type: none">▶ Charge the battery or replace it (page 11).
<p>"Base" flashes on the display.</p> <ol style="list-style-type: none">1. The handset is outside the range of the base.<ul style="list-style-type: none">▶ Reduce the distance between the handset and the base.2. The base's range is reduced because Eco Mode is activated.<ul style="list-style-type: none">▶ Deactivate Eco Mode (page 91) or reduce the distance between the handset and the base.3. The base is not activated.<ul style="list-style-type: none">▶ Check the base power adapter (page 18).4. The firmware is currently being updated.<ul style="list-style-type: none">▶ Please wait until the update is complete.5. Handset has not been registered with the base or has been de-registered.<ul style="list-style-type: none">▶ Register the handset (page 94).
<p>The handset does not ring.</p> <ol style="list-style-type: none">1. The ringtone is switched off.<ul style="list-style-type: none">▶ Activate the ringtone (page 103).2. Call divert set for "All Calls".<ul style="list-style-type: none">▶ Deactivate call divert (→ page 51).3. The connection on which the call is received is not assigned to the handset as a receive connection.<ul style="list-style-type: none">▶ Change the assignment of receive connections (▶ Web configurator).4. The phone only rings if the phone number has been transferred.<ul style="list-style-type: none">▶ Activate the ringtone for unknown calls (page 103).
<p>You cannot hear a ringtone/dialling tone from the fixed line.</p> <p>The phone cord supplied has not been used or has been replaced by a new cord with the wrong pin connections or the phone cord may be defective.</p> <ul style="list-style-type: none">▶ Please always use the phone cord supplied or ensure that the pin connections are correct when purchasing from a retailer (page 157).
<p>The connection always terminates after approx. 30 seconds.</p> <p>Repeater activated/deactivated (page 110).</p> <ul style="list-style-type: none">▶ Activate/deactivate the handset (page 37).
<p>Some of the select services do not work as specified.</p> <p>Features are not activated.</p> <ul style="list-style-type: none">▶ Query with the network provider.
<p>Error tone sounds after system PIN prompt.</p> <p>You have entered the wrong system PIN.</p> <ul style="list-style-type: none">▶ Repeat input of system PIN.

<p>Forgotten system PIN.</p> <ul style="list-style-type: none"> ▶ Reset the system PIN to 0000 (page 111).
<p>The other party cannot hear you.</p> <p>You pressed the mute key  during a call. The handset is "muted".</p> <ul style="list-style-type: none"> ▶ Unmute the microphone (page 50).
<p>The number of the caller is not displayed although CLIP has been set.</p> <p>Calling Line Identification is not enabled.</p> <ul style="list-style-type: none"> ▶ The caller should ask the network provider to enable Calling Line Identification (CLI). Refer to the notes on calling line display → page 47.
<p>You hear an error tone when keying an input.</p> <p>Action has failed/invalid input.</p> <ul style="list-style-type: none"> ▶ Repeat the process. ▶ Read the display and refer to the user guide if necessary.
<p>You cannot listen to messages on the network mailbox.</p> <p>Your PABX is set to pulse dialling.</p> <ul style="list-style-type: none"> ▶ Set your PABX to tone dialling.
<p>No time is specified for a message in the call list.</p> <p>Date/time have not been set.</p> <ul style="list-style-type: none"> ▶ Set date/time or ▶ Activate synchronisation with a time server on the Internet via the Web configurator.
<p>Firmware update or VoIP profile download is not carried out.</p> <ol style="list-style-type: none"> 1. If Currently not possible is displayed, the VoIP connections may be busy or a download/update is already being performed. <ul style="list-style-type: none"> ▶ Repeat the process at a later date. 2. If File unreadable is displayed, the firmware file may be invalid. <ul style="list-style-type: none"> ▶ Use only the firmware available on the preconfigured Gigaset configuration server. 3. If Server not accessible is displayed, the download server may not be accessible. <ul style="list-style-type: none"> ▶ The server is currently not accessible. Repeat the process at a later date. ▶ You have changed the preconfigured server address. Correct the address. If necessary, reset the base. 4. If Transmission error XXX is displayed, an error has occurred during the transmission of the file. An HTTP error code is displayed in place of XXX. <ul style="list-style-type: none"> ▶ Repeat the process. If the error occurs again, consult the Service department. 5. If Check IP settings is displayed, your phone may not be connected to the Internet. <ul style="list-style-type: none"> ▶ Check the cable connections between the base and router and between the router and the Internet. ▶ Check whether the phone is connected to the LAN, i.e., it can be reached at its IP address.
<p>You cannot establish a connection to the phone with your PC's Web browser.</p> <ul style="list-style-type: none"> ▶ When establishing a connection, check the phone's local IP address that has been entered. You can check the IP address on your handset (page 106). ▶ Check the connections between the PC and base. Transmit a ping command to your base, e.g., from your PC (ping <base's local IP address>). ▶ You have tried to reach the phone via a secure http (https://...). Try again with http://...

Exclusion of liability

Some displays may contain pixels (picture elements) which remain activated or deactivated.

This is completely normal and does not indicate a fault.

Information on operating Gigaset VoIP telephones with routers with Network Address Translation (NAT)

In general no special telephone or router configuration is required when operating a Gigaset VoIP phone with NAT router. The configuration settings described in this section are only necessary if you encounter one of the following problems.

Typical problems caused by NAT

- ◆ No incoming calls are possible via VoIP. Calls to your VoIP phone number are not put through.
- ◆ Outgoing calls via VoIP are not connected.
- ◆ A connection is established with the other party, but you cannot hear them and/or they cannot hear you.

Possible solution

- 1 Change the port numbers of the communication ports (SIP and RTP ports) on your phone (→ "**1. Changing the port numbers for SIP and RTP on your VoIP phone**").
- 2 In some cases, you must also define port forwarding for the phone's communication ports on the router (→ "**2. Setting port forwarding on the router**").

1. Changing the port numbers for SIP and RTP on your VoIP phone

On your VoIP phone, define different (local) port numbers for the SIP and RTP ports (between 1024 and 49152).

- ◆ These numbers must not be used by any other application or host in the LAN and
- ◆ must be considerably higher or lower than the SIP and RTP port numbers that you usually use (and are preset on the phone).

This procedure is particularly useful if additional VoIP phones are connected to the router.

To change the SIP and RTP port numbers on your VoIP phone, proceed as follows:

- ▶ Connect your PC's browser to the Web configurator of the phone and log in.
- ▶ Open the Web page **Settings ▶ Telephony ▶ Advanced VoIP Settings** and change the settings for the SIP and RTP ports (→ **page 135**).

To help you remember the new port numbers (e.g., for router configuration), you can choose port numbers that are very similar to the standard settings, e.g.:

SIP port	49060	instead of	5060
RTP port	49004 to 49010	instead of	5004 to 5010

- ▶ Save the changes on your phone.
- ▶ Wait for the active VoIP connections to be re-registered. To do so, switch to the Web page **Settings ▶ Telephony ▶ Connections** to see the **Status** of your VoIP connections.

- ▶ Check to see whether the problem persists. If it does, perform step 2.

2. Setting port forwarding on the router

To ensure that your specified SIP and RTP port numbers are used on the WAN interface with the public IP address, you must define port forwarding rules for the SIP and RTP ports on the router.

To define port forwarding on the router, proceed as follows:

The terms used below may vary from router to router.

To release a port, you must enter the following details (example):

Protocol	Public port	Local port	Local host (IP)	
UDP	49060	49060	192.168.2.10	for SIP
UDP	49004–49010	49004–49010	192.168.2.10	for RTP

Protocol

Enter **UDP** as the protocol to be used.

Public port

Port number/port number range on the WAN interface

Local port

The SIP and RTP port numbers set on the phone.

In the new firmware version for Gigaset VoIP telephones, you can set a RTP port range. In this case, you must also define corresponding port forwarding for this range.

Local host (IP)

Local IP address of your phone in the LAN. You can see the phone's current IP address in the handset display by pressing the paging button on the base.

To enable the router to perform this port forwarding, the DHCP settings of the router must ensure that the phone is always assigned the same local IP address, i.e., the DHCP does not change the IP address assigned to the phone during operation. Alternatively, you can assign a fixed (static) ID address to the phone. However, you must ensure that this IP address is not within the address range reserved for DHCP and is not assigned to any other LAN subscriber.

VoIP status codes

In the following tables you will find the meaning of the most important VoIP status codes and messages.

Status code	Meaning
0x31	IP configuration error: IP domain not entered.
0x33	IP configuration error: SIP username (Provider Data User ID) not entered. This is shown, for example, when dialling with a line suffix, if no connection is configured for the suffix on the base.
0x34	IP configuration error: SIP password (Provider Data Password) not entered.
0x300	The called party can be reached under multiple phone numbers. If the VoIP provider supports this, a list of the phone numbers is transmitted as well as the status code. The caller can select the number to which he wants to make the connection.
0x301	Permanently diverted. The called party can no longer be reached under this number. The new number is transferred to the phone together with the status code, and the phone then no longer accesses the old number but dials the new address immediately.
0x302	Temporarily diverted. The phone is informed that the called party cannot be reached under the dialled number. The call is diverted for a limited period. The phone is also notified of the length of the diversion.
0x305	The query is sent to a different "proxy server", e.g., to balance incoming queries. The phone will make the same query once again to another proxy server. This is not a redirection of the address per se.
0x380	Other service: The query or call could not be transferred. However, the phone is notified of other options available to connect the call.
0x400	Wrong call
0x401	Not authorised
0x403	The requested service is not supported by the VoIP provider.
0x404	Wrong phone number. No connection on this number. Example: While making a local call you have not dialled the area code although your VoIP provider does not support local calls.
0x405	Method not permitted.
0x406	Not acceptable. The requested service cannot be provided.
0x407	Proxy authentication required.
0x408	The party cannot be reached (e.g., account has been deleted).
0x410	The requested service is not available from the VoIP provider.
0x413	Message is too long.

Customer Service & Assistance

Status code	Meaning
0x414	URI is too long.
0x415	Query format is not supported.
0x416	URI is faulty.
0x420	Incorrect ending
0x421	Incorrect ending
0x423	The requested service is not supported by the VoIP provider.
0x480	The dialled number is temporarily unavailable.
0x481	The recipient is not available.
0x482	Double service query
0x483	Too many "jumps": The query was rejected because the service server (proxy) has decided that this query has already passed through too many service servers. The maximum number is defined beforehand by the original sender of the query.
0x484	Wrong number: In most cases this response means that you have simply omitted one or more digits in the phone number.
0x485	The URI dialled is not unique and cannot be processed by the VoIP provider.
0x486	The called party is busy.
0x487	General faults: The call was cancelled before a call was established. The status code confirms receipt of the interruption signal.
0x488	The server cannot process the query because the data entered in the media description is not compatible.
0x491	The server reports that the query will be processed as soon as a previous query has been completed.
0x493	The server rejects the query because the phone cannot decrypt the message. The sender has used an encryption method that either the server or the receiver phone cannot decrypt.
0x500	The proxy or the receiving device has discovered a fault while executing the query. It is therefore impossible to execute the query. If this occurs, the caller or the phone displays the fault and repeats the query after a few seconds. The number of seconds after which the query can be repeated may be transmitted to the caller or phone by the receiving device.
0x501	The query cannot be processed by the recipient because the recipient does not have the functionality that the caller requires. If the recipient understands the query but does not process it because the sender does not have the necessary rights or the query is not permitted in the current context, status code 405 is transmitted instead of 501.
0x502	In this case, the receiving device that transmits this error code is a proxy or a gateway and has received an invalid response from its gateway via which this query is to be processed.

Status code	Meaning
0x503	The query cannot be processed by the receiving device or the proxy at present because the server is either overloaded or is being serviced. If it is possible for the query to be repeated in the foreseeable future, the server informs the caller or the phone of this.
0x504	Time limit exceeded at the gateway
0x505	The server rejects the query because the indicated version number of the SIP protocol does not concur with at least the version that is used by the server or SIP device involved in this query.
0x515	The server rejects the query because the message exceeds the maximum permitted size.
0x600	The called party is busy.
0x603	The called party has rejected the call.
0x604	The called URI does not exist.
0x606	The communication settings are not acceptable.
0x701	The called party has hung up.
0x703	Connection cancelled because of timeout.
0x704	Connection interrupted because of an SIP error.
0x705	Wrong dialling tone
0x706	No connection established
0x751	Busy tone: No codec match between the calling and called party.
0x810	General socket layer error: User is not authorised.
0x811	General socket layer error: Wrong socket number
0x812	General socket layer error: Socket is not connected.
0x813	General socket layer error: Memory error
0x814	General socket layer error: Socket not available – check IP settings/connection problem/VoIP setting incorrect.
0x815	General socket layer error: Illegal application on the socket interface.

Checking service information

If you contact Customer Care, you may need the base's service information.

Prerequisite: You are trying to establish an external call or are conducting an external call.

Please note

You may need to wait a few seconds before **Menu** appears on the display

Menu ▶ Service Info

Confirm selection with **OK**.

You can select the following information/functions with **[↕]**:

- 1: Serial number of the base (RFPI)
- 2: IPUI (International Portable User Identity) of the handset used
- 3: Informs the service employees of the base settings (in hex diagram), e.g., the number of registered handsets, repeater mode.
- 4: Variant (digits 1 to 2),
Version of the phone's firmware (digits 3 to 5).
- 5: Gigaset.net number of your phone. A service employee can use this number to call you over the Internet without you needing to be registered with a VoIP provider. This means that the employee can test online connections and VoIP telephony regardless of the VoIP provider.
- 6: Device number of the base. This contains additional information for the service employee.

Unlock system

(only if the device has been locked by the provider)

Confirm selection with **OK**.

If necessary you can unlock a provider-specific device lock with a corresponding code.

Update profile

Confirm selection with **OK**.

Your current VoIP provider profiles (general provider data for all configured VoIP connections) are automatically loaded onto your phone. The general settings for all VoIP connections for which profiles are available on the Internet are updated.

Send config.

Select this option only if you are requested to do so by the service employee.

Authorisation

This device is intended for analogue phone lines in your network.

Voice over IP telephony is possible with an additional modem via the LAN interface.

Country-specific requirements have been taken into consideration.

We, Gigaset Communications GmbH, declare that this device meets the essential requirements and other relevant regulations laid down in Directive 1999/5/EC.

A copy of the 1999/5/EC Declaration of Conformity is available at this Internet address:

www.gigaset.com/docs

CE 0682

Environment

Our environmental mission statement

We, Gigaset Communications GmbH, bear social responsibility and are actively committed to a better world. Our ideas, technologies and actions serve people, society and the environment. The aim of our global activity is to secure sustainable life resources for humanity. We are committed to a responsibility for our products that comprises their entire life cycle. The environmental impact of products, including their manufacture, procurement, distribution, utilisation, service and disposal, are already evaluated during product and process design.

Further information on environmentally friendly products and processes is available on the Internet at www.gigaset.com.

Environmental management system



Gigaset Communications GmbH is certified pursuant to the international standards ISO 14001 and ISO 9001.

ISO 14001 (Environment): Certified since September 2007 by TÜV SÜD Management Service GmbH.

ISO 9001 (Quality): Certified since 17/02/1994 by TÜV SÜD Management Service GmbH.

Disposal

Batteries should not be disposed of in general household waste. Observe the local waste disposal regulations, details of which can be obtained from your local authority.

All electrical and electronic equipment must be disposed of separately from general household waste using the sites designated by local authorities.

Environment



If a product displays this symbol of a crossed-out rubbish bin, the product is subject to European Directive 2002/96/EC.

The appropriate disposal and separate collection of used equipment serve to prevent potential harm to the environment and to health. They are a precondition for the re-use and recycling of used electrical and electronic equipment.

For further information on disposing of your used equipment, please contact your local authority or your refuse collection service.

Appendix

Caring for your telephone

Wipe the unit with a **damp cloth** or an **antistatic cloth**. Do not use solvents or microfibre cloths.

Never use a dry cloth; this can cause static.

Contact with liquid

If the handset has come into contact with liquid:

- 1 **Switch the handset off and remove the batteries immediately.**
- 2 Allow the liquid to drain from the handset.
- 3 Pat all parts dry, then place the handset with the battery compartment open and the keypad facing down in a dry, warm place **for at least 72 hours** (not in a microwave, oven etc.).
- 4 **Do not switch on the handset again until it is completely dry.**

When it has fully dried out, you will usually be able to use it again.

Specifications

Batteries

Technology:

Nickel-metal-hydride (NiMH)

Size: AAA (Micro, HR03)

Voltage: 1,2 V

Capacity: 550 - 1000 mAh

The device is supplied with two approved batteries.

Handset operating times/charging times

This Gigaset can charge batteries up to a capacity of 1000 mAh. Using special high-performance batteries or batteries with high capacities is not recommended for cordless phones.

The operating time of your Gigaset depends on the capacity and age of the batteries and the way it is used. (Standby times/talktimes/operating times are maximum possible times, charging times are typical values).

	Capacity (mAh) approx.			
	550	700	800	1000
Standby time (hours)	220	255	290	360
Talktime (hours)	20	23	27	33
Operating time for 1.5 h of calls per day (hours)				
without Eco Mode+/with Eco Mode+	130 / 90	150 / 105	170 / 120	210 / 150
Charging time in base (hours)	6.5	7.5	8.5	10.5
Charging time in charger (hours)	5.5	6.5	7	9

Due to the constant progression in battery development, the list of recommended batteries in the FAQ section of the Gigaset Customer Care pages is updated regularly:

www.gigaset.com/service

Base power consumption

In standby mode: approx. 1.2 W

During a call: approx 1.3 W

General specifications

DECT standard	Supported
GAP standard	Supported
No. of channels	60 duplex channels
Radio frequency range	1880–1900 MHz
Duplex method	Time multiplex, 10 ms frame length
Repeat frequency of the transmission pulse	100 Hz
Length of the transmission pulse	370 µs
Channel grid	1728 kHz
Bit rate	1152 kbit/s
Modulation	GFSK
Language code	32 kbit/s
Transmission power	10 mW average power per channel, 250 mW pulse power
Range	Up to 300 m outdoors, up to 50 m indoors
Base power supply	230 V ~/50 Hz
Ambient conditions for operation	+5°C to +45°C, 20% to 75% relative humidity
Dialling mode	DTMF (tone dialling)

Pin connections on the telephone jack

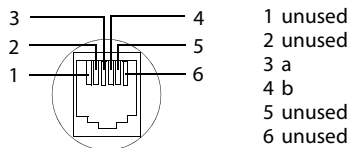

Writing and editing text

The following rules apply when writing text:

- ◆ Multiple letters and characters are assigned to each key between **[0_]** and **[9myz]** as well as **[* a]** and **[# -]**.
- ◆ Control the cursor with **[←]** **[→]** **[↑]** **[↓]**.
- ◆ Characters are inserted at the cursor position.
- ◆ Press the display key **Del.** to delete the **character** to the left of the cursor.
- ◆ The first letter of the name of directory entries is automatically capitalised, followed by lower case letters.

Setting upper/lower case or digits

Repeatedly press the hash key **[# -]** to change the text input mode.

123	Digits
Abc	Upper case *
abc	Lower case

* First letter in capitals, all others in lower case

When the mode is changed, the active mode is indicated at the bottom left of the screen.

Writing an SMS/names

- ▶ Enter the individual letters/characters by pressing the corresponding key.

The characters assigned to the key are shown in a selection line at the bottom left of the screen. The selected character is highlighted.

- ▶ **Briefly** press the key several times in succession to select the required letter/character.

Standard characters

	1x	2x	3x	4x	5x	6x	7x	8x	9x	10x	11x	12x	13x	14x	15x	16x
1. []	1	€	£	¥	¤											
2. []	a	b	c	2	ä	á	â	ã	ç							
3. []	d	e	f	3	ë	é	è									
4. []	g	h	i	4	ï	í	ì	î								
5. []	j	k	l	5												
6. []	m	n	o	6	ö	ñ	ó	ò	õ							
7. []	p	q	r	s	7	ß										
8. []	t	u	v	8	ü	ú	ù									
9. []	w	x	y	z	9	ÿ	ÿ	æ	ø	ã						
0. []	¹⁾	.	,	?	!	²⁾	←	0	+	-	:	¿	¡	"	'	; _
* []	*	/	()	<	=	>	%								
# []	#	@	\	&	§											

- 1) Space
- 2) Line break

Central European

	1x	2x	3x	4x	5x	6x	7x	8x	9x	10x	11x	12x	13x	14x
1. []	1	€	£	¤										
2. []	a	b	c	2	ą	ä	á	â	ć	ç				
3. []	d	e	f	3	ę	ë	é							
4. []	g	h	i	4	í	î								
5. []	j	k	l	5	ł									
6. []	m	n	o	6	ń	ó	ö	õ	ô					
7. []	p	q	r	s	7	ß	ś							
8. []	t	u	v	8	ű	ü	ú							
9. []	w	x	y	z	9	ý	ź	ż						
0. []	¹⁾	.	,	?	!	²⁾	←	0	+	-	:	"	'	; _
* []	*	/	()	<	=	>	%						
# []	#	@	\	&	§									

- 1) Space
- 2) Line break

Glossary

A

ADSL

Asymmetric Digital Subscriber Line

Special form of **DSL**.

ALG

Application Layer Gateway

NAT control mechanism of a router.

Many routers with integrated NAT use ALG. ALG lets the data packets in a VoIP connection pass and adds the public IP address of the secure private network.

The router's ALG should be deactivated if the VoIP provider offers a STUN server or an outbound proxy.

See also: **Firewall, NAT, Outbound proxy, STUN**.

Authentication

Restriction of access to a network/service by using an ID and password to log in.

Automatic ringback

See **Ringback when the number is busy**.

B

Block dialling

Enter the complete phone number, and correct it if necessary. Then pick up the earpiece or press the talk/speaker key to dial the phone number.

Broadband Internet access

See **DSL**.

C

Call divert

CD

Automatic diversion (CD) of a call to a different telephone number. There are three kinds of call divert:

- CDU, Call Divert Unconditional
- CDB, Call Divert Busy
- CDNR, Call Divert No Reply

Call swapping

Call swapping allows you to switch between two callers or between a conference and an individual caller without allowing the waiting caller to listen to the call.

Call waiting

= CW.

Network provider feature. A beep during a call indicates that another caller is waiting. You can accept or reject the second call. You can activate/deactivate the feature.

Glossary

CF

Call Forwarding

See **Call divert**.

Client

Application that requests a service from a server.

Codec

Coder/decoder

Codec is a procedure that digitises and compresses analogue voice before it is sent via the Internet, and decodes – i.e., translates into analogue voice – digital data when voice packets are received. There are different codecs with differing degrees of compression, for instance.

Both parties involved in the telephone connection (caller/sender and recipient) must use the same codec. This is negotiated between the sender and the recipient when establishing a connection.

The choice of codec is a compromise between voice quality, transmission speed and the necessary bandwidth. A high level of compression, for example, means that the bandwidth required for each voice connection is low. However, it also means that the time needed to compress/decompress the data is greater, which increases execution time for data in the network and thus impairs voice quality. The time required increases the delay between the sender speaking and the recipient hearing what has been said.

COLP/COLR

Connected Line Identification Presentation/Restriction

Feature provided by a VoIP/ISDN connection for outgoing calls.

COLP displays the phone number accepting the call on the calling party's display unit.

The number of the party accepting the call is different to the dialled number, e.g., if the call is diverted or transferred.

The called party can use COLR (Connected Line Identification Restriction) to prevent the number from appearing on the calling party's display.

Consultation call

You are on a call. With a consultation call, you interrupt the conversation briefly to establish a second connection to another participant. If you end the connection to this participant immediately, then this was a consultation call. If you switch between the first and second participant, it is called **Call swapping**.

CW

Call Waiting

See **Call waiting**.

D**DHCP**

Dynamic Host Configuration Protocol

Internet protocol that handles the automatic assignment of **IP addresses** to **Network subscribers**. The protocol is made available in the network by a server. A DHCP server can, for example, be a router.

The phone contains a DHCP client. A router that contains a DHCP server can assign the IP addresses for the phone automatically from a defined address block. The dynamic assignment means that several **Network subscribers** can share one IP address, although they can only use it alternately and not simultaneously.

With some routers you can specify that the IP address for the phone is never changed.

Displayed name

VoIP provider feature. You can specify any name that is to be shown to the other party during a call instead of your phone number.

DMZ (Demilitarised Zone)

DMZ describes a part of a network that is outside the firewall.

A DMZ is set up, as it were, between a network you want to protect (e.g., a LAN) and a non-secure network (e.g., the Internet). A DMZ permits unrestricted access from the Internet to only one or a few network components, while the other network components remain secure behind the firewall.

DNS

Domain Name System

Hierarchical system that permits the assignment of **IP addresses** to **Domain names** that are easier to memorise. This assignment has to be managed by a local DNS server in each (W)LAN. The local DNS server determines the IP address, if necessary by enquiring about superordinate DNS servers and other local DNS servers on the Internet.

You can specify the IP address of the primary/secondary DNS server.

See also: **DynDNS**.

Domain name

Name of one (of several) web server(s) on the Internet (e.g., Gigaset.net). The domain name is assigned to the relevant IP address by DNS.

DSCP

Differentiated Service Code Point

See **Quality of Service (QoS)**.

DSL

Digital Subscriber Line

Data transfer technology that allows Internet access with e.g., **1.5 Mbps** over a conventional telephone line. Prerequisites: DSL modem and the appropriate service offered by the Internet provider.

DSLAM

Digital Subscriber Line Access Multiplexer

The DSLAM is a switch cabinet in an exchange at which all subscriber connectors converge.

Glossary

DTMF

Dual Tone Multi-Frequency

Dual tone multi-frequency dialling (DTMF).

Dynamic IP address

A dynamic IP address is assigned to a network component automatically via **DHCP**. The dynamic IP address for a network component can change every time it registers or at certain time intervals.

See also: **Fixed IP address**.

DynDNS

Dynamic DNS

Domain names and IP addresses are assigned via **DNS**. For **Dynamic IP addresses** this service is enhanced with "Dynamic DNS". This permits the use of a network component with a dynamic IP address as a **Server** on the **Internet**. DynDNS ensures that a service can always be addressed on the Internet under the same **Domain name**, regardless of the current IP address.

E

ECT

Explicit Call Transfer

Participant A calls participant B. The participant puts the connection on hold and calls participant C. Rather than connect everyone in a three-party conference, A now transfers participant B to C and hangs up.

EEPROM

Electrically Erasable Programmable Read Only Memory

Memory building block in your phone with fixed data (e.g., default and customised settings) and data saved automatically (e.g., call list entries).

Ethernet network

Wired **LAN**.

F

Firewall

You can use a firewall to protect your network against unauthorised external access. This involves combining various measures and technologies (hardware and/or software) to control the flow of data between a private network you wish to protect and an unprotected network (e.g., the Internet).

See also: **NAT**.

Firmware

Device software in which basic information is saved for the functioning of a device. To correct errors or update the device software, a new version of the firmware can be loaded into the device's memory (firmware update).

Fixed IP address

A fixed IP address is assigned to a network component manually during network configuration. Unlike the **Dynamic IP address**, a fixed IP address does not change.

Flat rate

Billing system for an **Internet** connection. The Internet provider charges a set monthly fee. There are no additional charges for the duration of the connection or number of connections.

Fragmentation

Data packets that are too big are split into smaller packets (fragments) before they are transferred. They are put together again when they reach the recipient (defragmented).

Full duplex

Data transmission mode in which data can be sent and received at the same time.

G

G.711 a law, G.711 μ law

Standard for a **Codec**.

G.711 delivers very good voice quality that corresponds to that in the ISDN network. As there is little compression, the necessary bandwidth is around 64 kbit/s per voice connection, but the delay caused by coding/decoding is only approx. 0.125 ms.

"a law" describes the European standard and " μ law" describes the North American/Japanese equivalent.

G.722

Standard for a **Codec**.

G.722 is a **broadband** language codec with a bandwidth of 50 Hz to 7 kHz, a net transmission rate of 64 kbit/s per voice connection and integrated speech pause recognition and comfort noise generation (silence suppression).

G.722 delivers very good voice quality. A higher sampling rate provides clearer and better voice quality than other codecs and enables a speech tone in High Definition Sound Performance (HDSP).

G.726

Standard for a **Codec**.

G.726 delivers good voice quality. It is inferior to the quality with codec **G.711** but better than with **G.729**.

G.729A/B

Standard for a **Codec**.

The voice quality is more likely to be lower with G.729A/B. As a result of the high level of compression, the necessary bandwidth is only around 8 kbit/s per voice connection, but the delay is around 15 ms.

Gateway

Connects two different **Networks**, e.g., a router as an Internet gateway.

For phone calls from **VoIP** to the telephone network, a gateway has to be connected to the IP network and the telephone network (gateway/VoIP provider). It forwards calls from VoIP to the telephone network as required.

Gateway provider

See **SIP provider**.

Global IP address

See **IP address**.

Glossary

GSM

Global System for Mobile Communication

Originally, a European standard for mobile networks. GSM can now be described as a worldwide standard. However, in the USA and Japan, national standards were previously more frequently supported.

H

Headset

Combination of microphone and headphone. A headset enables a comfortable handsfree mode. Headsets that can be connected to the base via a cable (wire-bound) or via Bluetooth (wireless) are available.

HTTP Proxy

Server via which the **Network subscribers** can process their Internet traffic.

Hub

Uses one **Infrastructure network** to connect several **Network subscribers**. All data sent to the hub by one network subscriber is forwarded to all network subscribers.

See also: **Gateway, Router**.

I

IEEE

Institute of Electrical and Electronics Engineers

International body that defines standards in electronics and electrical engineering, concerned in particular with the standardisation of LAN technology, transmission protocols, data transfer rate and wiring.

Infrastructure network

Network with central structure: All **Network subscribers** communicate via a central **Router**.

Internet

Global **WAN**. A series of protocols known as TCP/IP have been defined for exchanging data.

Every **Network subscriber** is identifiable via their **IP address**. **DNS** assigns a **Domain name** to the **IP address**.

Important services on the Internet include the World Wide Web (WWW), e-mail, file transfer and discussion forums.

Internet Service Provider

Enables access to the Internet for a fee.

IP (Internet Protocol)

TCP/IP protocol on the **Internet**. IP is responsible for addressing subscribers in a **Network** using **IP addresses** and transfers data from the sender to the recipient. IP determines the paths (routing) along which the data packets travel.

IP address

A unique address for a network component within a network based on the TCP/IP protocols (e.g., LAN, Internet). On the **Internet**, domain names are usually assigned instead of IP addresses. **DNS** assigns the corresponding IP address to the domain name.

The IP address has four parts (decimal numbers between 0 and 255) separated by full stops (e.g., 230.94.233.2).

The IP address is made up of the network number and the number of the **Network subscriber** (e.g., phone). Depending on the **Subnet mask**, the first one, two or three parts make up the network number and the rest of the IP address addresses the network component. The network number of all the components in any one network must be identical.

IP addresses can be assigned automatically with DHCP (dynamic IP addresses) or manually (fixed IP addresses).

See also: **DHCP**.

IP pool range

Range of IP addresses that the DHCP server can use to assign dynamic IP addresses.

L**LAN**

Local Area Network

Network with a restricted physical range. A LAN can be wireless (WLAN) and/or wired.

Local IP address

The local or private IP address is the address for a network component in the local network (LAN). The network operator can assign any address they want. Devices that act as a link from a local network to the Internet (gateway or router) have a public and a private IP address.

See also **IP address**.

Local SIP port

See **SIP port/Local SIP port**.

M**MAC address**

Media Access Control address

Hardware address by means of which each network device (e.g., network card, switch, phone) can be uniquely identified worldwide. It consists of six parts (hexadecimal numbers) separated by "-" (e.g., 00-90-65-44-00-3A).

The MAC address is assigned by the manufacturer and cannot be changed.

Mbps

Million bits per second

Unit of the transmission speed in a network.

MRU

Maximum Receive Unit

Defines the maximum user data volume within a data packet.

MTU

Maximum Transmission Unit

Defines the maximum length of a data packet that can be carried over the network at a time.

Glossary

Music on hold

Music on hold

Music that is played while you are on a **Consultation call** or during **Call swapping**. The waiting participant hears music while on hold.

N

NAT

Network Address Translation

Method for converting (private) **IP addresses** to one or more (public) IP addresses. NAT enables the IP addresses of **Network subscribers** (e.g., VoIP telephones) in a **LAN** to be concealed behind a shared IP address for the **Router** on the **Internet**.

VoIP telephones behind a NAT router cannot be reached by VoIP servers (on account of the private IP address). To "get around" NAT, it is possible to use either **ALG** in the router, **STUN** in the VoIP telephone, or for the VoIP provider to use an **Outbound proxy**.

If an outbound proxy is made available, you must allow for this in the VoIP settings for your phone.

Network

Group of devices. Devices can be connected in either wired or wireless mode.

Networks can also differ in range and structure:

- Range: Local networks (**LAN**) or wide-area networks (**WAN**)
- Structure: **Infrastructure network** or ad-hoc network

Network subscriber

Devices and PCs that are connected to each other in a network e.g., servers, PCs and phones.

O

Outbound proxy

Alternative NAT control mechanism to STUN and ALG.

Outbound proxies are implemented by the VoIP provider in firewall/NAT environments as an alternative to **SIP proxy servers**. They control data traffic through the firewall.

Outbound proxy and STUN servers should not be used simultaneously.

See also: **STUN** and **NAT**.

P

Paging (handset search)

Base function for locating the registered handsets. The base establishes a connection to every registered handset. The handsets start to ring.

PIN

Personal Identification Number

Protects against unauthorised use. When the PIN is activated, a number combination has to be entered to access a protected area.

You can protect your base configuration data with a system PIN (4-digit number combination).

Port

Data is exchanged between two applications in a **Network** via a port.

Port forwarding

The Internet gateway (e.g., your router) forwards data packets from the **Internet** that are directed to a certain **Port** to the port concerned. This allows servers in the **LAN** to offer services on the Internet without you needing a public IP address.

Port number

Indicates a specific application of a **Network subscriber**. Depending on the setting in the **LAN**, the port number is permanently assigned or it is assigned with each access.

The combination of **IP address/Port** number uniquely identifies the recipient or sender of a data packet within a network.

Pre-dialling

See **Block dialling**.

Private IP address

See **Public IP address**.

Protocol

Describes the agreements for communicating within a **Network**. It contains rules for opening, administering and closing a connection, about data formats, time frames and possible error handling.

Proxy/Proxy server

Computer program that controls the exchange of data between **Client** and **Server** in computer networks. If the phone sends a query to the VoIP server, the proxy acts as a server towards the phone and as a client towards the server. A proxy is addressed via **IP address/Domain names** and **Port**.

Public IP address

The public IP address is the address for a network component on the Internet. It is assigned by the Internet service provider. Devices that act as a link from a local network to the Internet (gateway, router) have a public and a local IP address.

See also: **IP address, NAT**.

Q**Quality of Service (QoS)**

Describes the quality of service in communication networks. Differentiations are made between various quality of service classes.

QoS influences the flow of data packets on the Internet e.g., by prioritising data packets, reserving bandwidth and optimising data packets.

In VoIP networks, QoS influences the voice quality. If the whole infrastructure (router, network server etc.) has QoS, the voice quality is better, i.e., fewer delays, less echoing, less crackling.

R**RAM**

Random Access Memory

Memory in which you have reading and storage rights. Items such as melodies and logos are saved in the RAM after you have loaded them onto the phone via the Web configurator.

Glossary

Registrar

The registrar manages the current IP addresses of the **Network subscriber**. When you register with your VoIP provider, your current IP address is saved on the registrar. This means you can also be reached when on the move.

Ringback when the call is not answered

= CCNR (Completion of calls on no reply). If a party does not reply when called, a caller can arrange an automatic ringback. As soon as the destination phone has completed a call and is free again, the caller is called back. This feature must be supported by the exchange. The ringback request is automatically cancelled after about two hours (depending on the network provider).

Ringback when the number is busy

= CCBS (Completion of calls to busy subscriber). If a caller hears the busy tone, he or she can activate the ringback function. As soon as the connection is free, the caller is called back. As soon as the caller lifts the earpiece, the connection is made automatically.

ROM

Read Only Memory

A type of memory that can only be read.

Router

Routes data packets within a network and between different networks via the quickest route. Can connect **Ethernet networks** and WLAN. Can be a **Gateway** to the Internet.

Routing

Routing is the transfer of data packets to another subscriber in your network. On their way to the recipient, the data packets are sent from one router to the next until they reach their destination.

If data packets were not forwarded in this way, a network like the Internet would not be possible. Routing connects the individual networks to this global system.

A router is a part of this system; it transfers data packets both within a local network and from one network to the next. Transfer of data from one network to another is performed on the basis of a common protocol.

RTP

Real-Time Transport Protocol

Global standard for transferring audio and video data. Often used in conjunction with UDP. In this case, RTP packets are embedded in UDP packets.

RTP port

(Local) **Port** that is used to send and receive voice data packets for VoIP.

S

Server

Provides a service to other **Network subscribers (Clients)**. The term can indicate a computer/PC or an application. A server is addressed via **IP address/Domain names** and **Port**.

SIP (Session Initiation Protocol)

Signalling protocol independent of voice communication. Used for establishing and ending a call. It is also possible to define parameters for voice transmission.

SIP address

See **URI**.

SIP port/Local SIP port

(Local) **Port** that is used to send and receive SIP signalling data for VoIP.

SIP provider

See **VoIP provider**.

SIP proxy server

IP address of your VoIP provider's gateway server.

Static IP address

See **Fixed IP address**.

STUN

Simple Transversal of UDP over NAT

NAT control mechanism.

STUN is a data protocol for VoIP telephones. STUN replaces the private IP address in the VoIP telephone data packets with the public address of the secure private network. To control data transfer, a STUN server is also required on the Internet. STUN cannot be implemented with symmetric NATs.

See also: **ALG, Firewall, NAT, Outbound proxy**.

Subnet

Segment of a **Network**.

Subnet mask

IP addresses consist of a fixed network number and a variable subscriber number. The network number is identical for all **Network subscribers**. The size of the network number part is determined in the subnet mask. In the subnet mask 255.255.255.0, for example, the first three parts of the IP address are the network number and the last part is the subscriber number.

Symmetric NAT

A symmetric NAT assigns different external IP addresses and port numbers to the same internal IP addresses and port numbers – depending on the external target address.

T**TCP**

Transmission Control Protocol

Transport protocol. Session-based transmission protocol: it sets up, monitors and terminates a connection between sender and recipient for transporting data.

TLS

Transport Layer Security

Protocol for encrypting data transmissions on the Internet. TLS is a superordinate **Transport protocol**.

Transmission rate

Speed at which data is transmitted in the **WAN** or **LAN**. The transmission rate is measured in data units per unit of time (Mbit/s).

Glossary

Transport protocol

Controls data transport between two communication partners (applications).

See also: **UDP**, **TCP**, **TLS**.

U

UDP

User Datagram Protocol

Transport protocol. Unlike **TCP**, **UDP** is a non session-based protocol. UDP does not establish a fixed connection. The data packets ("datagrams") are sent as a broadcast. The recipient is solely responsible for making sure the data is received. The sender is not notified about whether it is received or not.

URI

Uniform Resource Identifier

Character string for identifying resources (e.g., e-mail recipient, <http://gigaset.com>, files).

On the **Internet**, URIs are used as a uniform identification for resources. URIs are also described as SIP addresses.

URIs can be entered in the phone as a number. By dialling a URI, you can call an Internet subscriber with VoIP equipment.

URL

Universal Resource Locator

Globally unique address of a domain on the **Internet**.

A URL is a subtype of the **URI**. URLs identify a resource by its location on the **Internet**. For historical reasons the term is often used as a synonym for URI.

User ID

See **User name**.

User name

Name/number combination for access e.g., to your VoIP account or your private address directory on the Internet.

V

Voice codec

See **Codec**.

VoIP

Voice over Internet Protocol

Telephone calls are no longer placed and transmitted over the telephone network but over the **Internet** (or other IP networks).

VoIP provider

A VoIP, SIP or **Gateway provider** is an Internet service provider that provides a **Gateway** for Internet telephony. As the phone works with the SIP standard, your provider must support the SIP standard.

The provider routes calls from VoIP to the telephone network (analogue, ISDN and mobile) and vice versa.

W

WAN

Wide Area Network

Wide-area network that is unrestricted in terms of area (e.g., **Internet**).

Accessories

Gigaset handsets

Upgrade your Gigaset to a cordless PABX:

Gigaset A510H handset

- ◆ Hear whom the call is for with VIP ringtones
- ◆ High-quality keypad
- ◆ 1.8" b/w display
- ◆ Directory for 150 entries
- ◆ Talk/standby time of up to 18 h/260 h, standard batteries
- ◆ Brilliant sound quality in handsfree mode
- ◆ Screensaver (digital clock)
- ◆ ECO DECT
- ◆ Alarm clock
- ◆ No interruptions from anonymous calls
- ◆ SMS with up to 160 characters

www.gigaset.com/gigasetA510h



Gigaset C300H handset

- ◆ Hear whom the call is for with VIP ringtones
- ◆ High-quality keypad with backlight
- ◆ 1.7" CSTN colour display
- ◆ Directory for 250 entries
- ◆ Talk/standby time of up to 20 h/300 h, standard batteries
- ◆ Brilliant sound quality in handsfree mode
- ◆ Screensaver (digital clock or picture)
- ◆ ECO DECT
- ◆ Alarm clock
- ◆ No interruptions from anonymous calls
- ◆ SMS with up to 160 characters

www.gigaset.com/gigasetc300h



Gigaset SL400H handset

- ◆ Genuine metal frame and keypad
- ◆ High-quality keypad backlight
- ◆ 1.8" TFT colour display
- ◆ Bluetooth® and mini USB
- ◆ Directory for up to 500 vCards
- ◆ Talk/standby time of up to 14 h/230 h
- ◆ Large font for call lists and directory
- ◆ Brilliant sound quality in handsfree mode with 4 adjustable handsfree profiles
- ◆ Caller pictures, slideshow and screensaver (analogue and digital clock)
- ◆ Silent alert, download ringtone melodies
- ◆ ECO DECT
- ◆ Alarm clock
- ◆ Calendar with appointment scheduler
- ◆ Night mode with time-controlled ringtone deactivation
- ◆ No interruptions from anonymous calls
- ◆ Room monitor (baby alarm), direct call
- ◆ SMS with up to 640 characters

www.gigaset.com/gigasetSL400h



Gigaset S810H handset

- ◆ Brilliant sound quality in handsfree mode
- ◆ High-quality genuine metal keypad with backlight
- ◆ Plus/minus key for simple volume control
- ◆ 1.8" TFT colour display
- ◆ Bluetooth® and mini USB
- ◆ Directory for up to 500 vCards
- ◆ Talk/standby time of up to 13 h/180 h, standard batteries
- ◆ Large font for call lists and directory
- ◆ Caller pictures, screensaver (analogue and digital clock)
- ◆ Download ringtone melodies
- ◆ ECO DECT
- ◆ Alarm clock
- ◆ Calendar with appointment scheduler
- ◆ Night mode with time-controlled ringtone deactivation
- ◆ No interruptions from anonymous calls
- ◆ Room monitor (baby alarm), direct call
- ◆ SMS with up to 640 characters

www.gigaset.com/gigasetS810h



Accessories

Gigaset C610H handset

- ◆ Social life management with room monitor and birthday reminders
- ◆ Individual programming of ringtones with 6 VIP groups
- ◆ High-quality keypad with backlight
- ◆ 1.8" TFT colour display
- ◆ Directory for up to 150 vCards
- ◆ Talk/standby time of up to 12 h/180 h, standard batteries
- ◆ Large font for call lists and directory
- ◆ Brilliant sound quality in handsfree mode
- ◆ Screensaver (digital clock)
- ◆ ECO DECT
- ◆ Alarm clock
- ◆ Night mode with time-controlled ringtone deactivation
- ◆ No interruptions from anonymous calls
- ◆ Room monitor (baby alarm), direct call
- ◆ SMS with up to 640 characters



www.gigaset.com/gigasetc610h

Gigaset E49H handset

- ◆ Resistant to shocks, dust and water splashes
- ◆ 1.7" CSTN colour display
- ◆ Hardy keypad with backlight
- ◆ Colour display
- ◆ Directory for up to 150 entries
- ◆ Talk/standby time of up to 12 h/250 h, standard batteries
- ◆ Brilliant sound quality in handsfree mode
- ◆ Screensaver
- ◆ ECO DECT
- ◆ Alarm clock
- ◆ Room monitor (baby alarm)
- ◆ SMS with up to 640 characters



www.gigaset.com/gigasete49h

L410 handsfree clip for cordless phones

- ◆ Complete freedom of movement when making calls
- ◆ Practical clip fastening
- ◆ Perfect sound quality in handsfree mode
- ◆ Weight approx. 30 g
- ◆ ECO DECT
- ◆ 5 volume settings
- ◆ LED status display
- ◆ Talk/standby time of up to 5 h/120 h
- ◆ Ranges in buildings up to 50 m, outdoors up to 300 m



www.gigaset.com/gigasetl410

Gigaset repeater

You can use the Gigaset repeater to increase the reception range between your Gigaset handset and the base

www.gigaset.com/gigasetrepeater



Compatibility

You can find more information about the handset functions in connection with the individual Gigaset bases at:

www.gigaset.com/compatibility

All accessories and batteries are available from your phone retailer.



Use only original accessories. This will avoid possible health risks and personal injury, and also ensure that all the relevant regulations are complied with.

Mounting the base on the wall

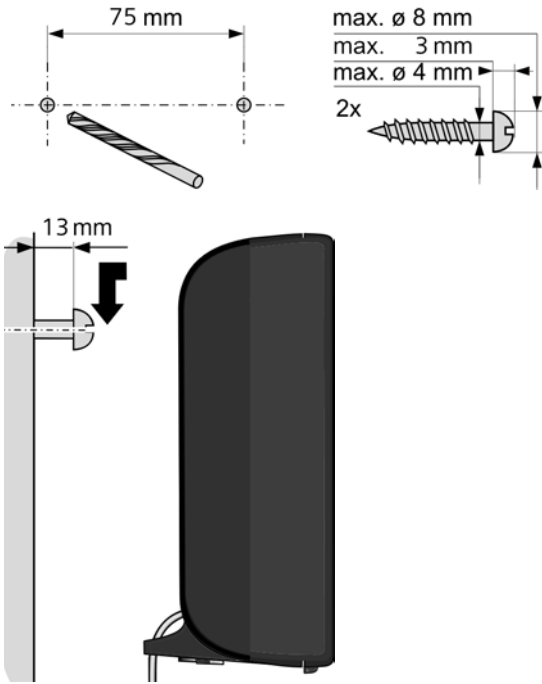

Mounting the charger on the wall

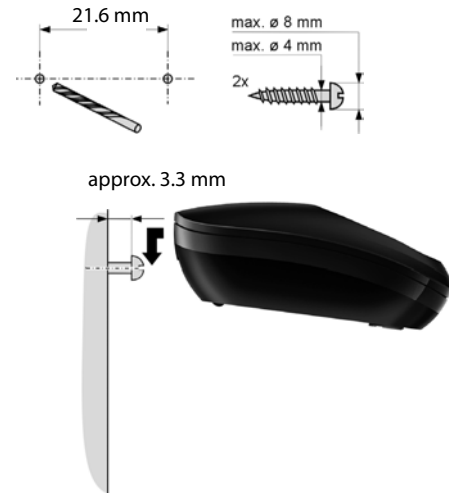

Index

A

- Accept key 5
- Access code
 - for PABX 113
- Accessories 172
- Acknowledge tones 104
- Activating
 - auto answer 101
 - call divert 51
 - handset 37
 - keypad lock 37
 - muting ringtone 77
 - network mailbox 88
 - withholding phone numbers 51
- ADSL 159
- Alarm clock 93
- ALG 159
- Alternative options 122
- Annex B for G.729, enabling 131
- Answering machine
 - configuring for fast access 89
- Application Layer Gateway (ALG) 159
- Arabic characters, entering 123
- Assigning number key 100
- Asymmetric Digital Subscriber Line 159
- Authentication 159
- Authorisation 153
- Auto
 - answer 46, 101
- Auto answer 101
- Auto configuration 22
- Auto configuration code 23
- Automatic version check 130, 140

B

- Base
 - connecting to PABX 113
 - power consumption 156
 - restoring to default settings 111
 - setting 105
 - setting up 16, 17
 - system PIN 106
 - updating firmware 109
- Battery
 - charging 5, 6, 14
 - display 5, 6
 - icon 5, 6

- inserting 11
- tone 104
- Block dialling 159
- Broadband connections 49
- Broadband Internet access 159
- Broadband voice codec 131, 163
- Buttons 123

C

- Call
 - accepting 46
 - ending 46
 - internal 96
 - transferring 56
 - transferring (connecting) 56, 96, 98
- Call divert 51, 159
 - Gigaset.net 51, 134
- Call duration 44
- Call forwarding 160
- Call lists 59
- Call swapping 55, 159
- Call waiting 159, 160
 - accepting/rejecting 54
 - activating/deactivating 53
 - external call 53
 - internal call 97
- Calling
 - entering IP address 45
 - from online directory 67
 - from Yellow Pages 67
 - Gigaset.net 71, 73
 - internal 96
 - unknown 51
- Calling Line Identification 46
- Certificate error 22, 84
- CF 160
- Changing
 - dialling mode 113
 - display language 15, 99
 - earpiece volume 101
 - handsfree volume 101
 - internal numbers 98
 - name of handset 98
 - pauses 114
 - ringtone 102
 - system PIN 106
- Changing the system PIN 106
- Character set 76, 79, 158
- Charge status indicator 5, 6
- Checkboxes 122

Index

- Checking service information 152
- CLI, CLIP 46
- Client 160
- CLIP picture 47
- Codes 160
- Colour scheme 100
- COLP 45, 160
- COLR 45, 160
- Conference (internal) 97
- Confirmation tone 104
- Connected Line Identification
 - Presentation/Restriction 45, 160
- Connecting
 - base to PABX 113
 - to the Web configurator 117
- Connection wizard
 - launching (getting started) 24
- Consultation call 55, 160
- Consultation call (internal) 97
- Consumption of electricity, see Power consumption
- Contrast 100
- Control key 5, 35
- Correcting incorrect entries 35
- Customer Care 142
- Customer Service & Assistance 142
- CW 160
- Cyrillic characters, entering 123
- D**
- Data packets, fragmentation 163
- Deactivating
 - auto answer 101
 - call divert 51
 - handset 37
 - keypad lock 37
 - muting ringtone 77
 - network mailbox 88
 - withholding phone numbers 51
- Delete key 7
- Deleting
 - characters 35
- Demilitarised Zone 161
- De-registering
 - from Web configurator 120
- De-registering (handset) 95
- DHCP 161, 162
- Dialling
 - IP address 45
 - using shortcuts 63
 - with directory 62
- Dialling pause 114
- Dialling plans
 - for emergency numbers 133
- Differentiated Service Code Point 161
- Digital Subscriber Line 161
- Digital Subscriber Line
 - Access Multiplexer 161
- Directory 61
 - copying number from text 64
 - Gigaset.net 70
 - managing entries 62
 - opening 35, 64
 - order of entries 61
 - saving entry 61
 - saving the sender's number (SMS) 79
 - searching for an entry 65
 - sending entry/list to handset 63
 - transferring to/from PC 137
 - using to enter numbers 64
- Directory file
 - content (vCard format) 138
- Directory transfer 137
- Display
 - changing display language 15, 99
 - colour scheme 100
 - contrast 100
 - in idle status 36
 - number (CLI/CLIP) 46
 - setting 99, 100
- Display keys 5, 7
 - assigning 100
- Display name (VoIP) 161
- Disposal 153
- DMZ 161
- DNS 161
- DNS server
 - preferred 107
- Domain name 161
- Domain Name System 161
- Draft message list (SMS) 75
- DSCP 161
- DSL 161
- DSLAM 161
- DTMF signalling for VoIP 134
- Dynamic DNS 162
- Dynamic Host Configuration
 - Protocol 161
- Dynamic IP address 162
- DynDNS 162

- E**
- Earpiece volume 101
 - Echo service from Gigaset.net 48
 - ECO DECT 91
 - Eco Mode 91
 - Eco Mode+ 91
 - ECT 56
 - activating/deactivating 53
 - E-mail
 - deleting 87
 - messages whilst making
 - a connection 86
 - notification 84
 - settings 136
 - viewing the sender's address 87
 - E-mail address 77
 - E-mail list 85
 - Emergency numbers
 - dialling plans for 133
 - End call key 5
 - Ending
 - call 46
 - Entering Cyrillic/Arabic
 - characters 123
 - Entry
 - selecting from directory 62
 - Environment 153
 - Error tone 104
 - Ethernet network 162
 - Explicit Call Transfer 162
 - External call
 - call waiting 53
- F**
- Factory settings 139
 - Fast access 89
 - Fax (SMS) 77
 - Firewall 162
 - Firmware 162
 - automatic update 110, 130, 140
 - checking version 152
 - starting update 109
 - updates 11
 - Fixed IP address 162
 - Flashing message key
 - activating/deactivating 59
 - Flat rate 162
 - Fragmentation of data packets 163
 - Full duplex 163
- G**
- G.711 μ law 131
 - G.711 a law 131
 - G.722 49, 131
 - G.722 broadband language codec 131
 - G.726 131
 - G.729 131
 - Gateway 163
 - Gateway provider 163
 - General troubleshooting 144
 - Gigaset config 117, 118
 - Gigaset HDSP, see HDSP
 - Gigaset.net 48
 - call divert 51, 134
 - calling subscriber 71, 73
 - changing/deleting own name 72
 - directory 70
 - echo service 48
 - entering name 72
 - searching for subscribers 70
 - Global IP address 163
 - Global System for
 - Mobile Communication 164
 - Group call 96
 - GSM 164
- H**
- Handset
- activating/deactivating 37
 - changing internal number 98
 - changing name 98
 - contact with liquid 155
 - de-registering 95
 - display language 15, 99
 - earpiece volume 101
 - handsfree volume 101
 - idle status 36
 - list 35
 - paging 95
 - registering 94
 - restoring to default settings 104
 - searching for 95
 - setting 99
 - setting up 11
 - transferring a call 96
 - using multiple 94
- Handsfree mode 50
 - Hash key 5, 37
 - HDSP 49, 131
 - Headset 164

Index

Hearing aids9
Help 144
High Definition Sound Performance,
 see HDSP
HTTP proxy 164
Hub 164

I

Icon
 alarm clock 93
 for new messages 58
 keypad lock 37
 new SMS 78
 ringtone 103

Idle status
 returning to 36

Idle status (display) 36

IEEE 164

Inbox (SMS) 77, 78

Incoming e-mail list, opening 85

Incoming message list
 opening (e-mail) 85

Incorrect entries (correction) 35

Infrastructure network 164

Initiating a conference 56

Input fields 122

Installation wizard 22

Institute of Electrical and
 Electronics Engineers 164

Interface language
 Web configurator 119

Internal
 conference 97
 consultation 97
 making calls 96

Internal call 96
 call waiting 97

Internal numbers, changing 98

Internet 164

Internet access (broadband) 159

Internet protocol 164

Internet service provider 164

IP 164

IP address 165
 assigning 106
 dialling 45
 display on handset 8
 fixed 162
 obtaining automatically 106

 static 169

IP configuration 106

IP pool range 165

K

Key 1 (fast access)5
 assigning 89

Key lock 37

Key, assigning 100

Keys
 assigning directory entry 63
 control key 5, 35
 delete key 7
 display keys 5, 7
 end call key 5
 fast access 5
 hash key 5, 37
 message key 5
 on/off key 5
 paging key (base) 8
 recall key 5
 shortcut 63
 star key 5
 talk key 5

L

LAN 165

Language
 display 15, 99
 Web configurator 119

List
 call lists 59
 e-mail notifications 85
 handsets 35
 missed calls 59
 network mailbox 58, 90
 SMS draft message list 75
 SMS incoming list 58, 78

Lists 122

Local Area Network 165

Local communication ports 135

Local IP address 165

Local SIP port 169

Locating
 handset 95

Lock
 activating/deactivating keypad
 lock 37

M

MAC address	165
checking	112
Making calls	
accepting a call	46
external	43
internal	96
Manual redial	57
Maximum Receive Unit	165
Maximum Transmission Unit	165
Mbps.	165
Media Access Control	165
Medical equipment	9
Menu	
end tone	104
opening	35
tree	40
using	36
Web configurator overview	125
Menu bar	121
Message	
deleting (e-mail)	87
playing back (network mailbox)	90
Message key	
activating/deactivating flashing	59
opening list	78
opening lists	58
Message list	
e-mail	85
network mailboxes	90
Messages	
key	5
Microphone	5
muting	50
Million bits per second	165
Missed calls	59
MRU	165
MTU	165
Music on hold	106, 166
Muting	
first ring	77
Muting the phone	50

N

Name	
display name (VoIP)	161
of handset	98
NAT	166
symmetric	169
Navigation area	122
Net directory	
Gigaset.net	70
Network	166
Ethernet	162
Network Address Translation	166
Network mailbox	88
activating/deactivating	88
calling	89, 90
configuring for fast access	89
entering number	88
list	90
Network MB, see Network mailbox	
Night mode see Time control	
Notification	
incoming e-mail	84
Notification via SMS	80
Number	
copying to directory	64
displaying caller's number (CLIP)	46
entering number of network mailbox	88
entering with directory	64
saving in the directory	61
Number display, withholding	51
O	
On/off key	5
Online directory	64
selecting	136
Operation (setting up the phone)	10
Options	122
Order in directory	61
Outbound proxy	166
Outside line code	113

Index

P

- PABX
 - connecting base 113
 - pauses 114
 - saving access code 113
 - setting dialling mode 113
 - setting recall 113
 - SMS 81
 - switching to tone dialling 115
- Package contents 10
- Paging 8, 95, 166
- Pause
 - after access code 114
 - after line seizure 114
 - after recall key 114
- PC address book entries
 - transferring to directory 137
- PC to Web configurator, connecting ... 117
- Personal Identification Number 166
- Phone
 - setting up 10
- Phone number display, notes 47
- Phone number display, withholding 51
- Phone number, withholding 51
- PIN 166
- Pin connections 157
- PIN, changing 106
- Port 166
- Port forwarding 167
- Port number 167
- Power adapter 9
- Power consumption (base) 156
- Preferred DNS server 107
- Prepare dialling 167
- Private IP address 167
- Protocol 167
- Proxy 167
- Proxy server 167
- Public IP address 167

Q

- Quality of Service 167
- Questions and answers 144

R

- R key
 - function for VoIP 135
- RAM 167
- Random Access Memory 167
- Read Only Memory 168
- Recall 113
- Recall key 5, 114
- Receive number
 - display on the handset 47
- Reception booster, see Repeater
- Redial 57
- Registering
 - with Web configurator 119
- Registering (handset) 94
- Registrar 168
- Repeater 110
- Resetting to the factory settings 139
- Restarting 139
- RFC 2833 (DTMF signalling) 134
- Ringback
 - when the call is not answered 168
 - when the number is busy 168
- Ringtone
 - changing 102
 - muting 77
 - setting melody 102
 - setting volume 102
- ROM 168
- Router 168
- Routing 168
- RTP 168
- RTP port 168

- S**
- Saving (access code)..... 113
 - Scope of delivery..... 10
 - Screensaver..... 99, 100
 - Searching for subscribers on
 - Gigaset.net..... 70
 - Searching in directory..... 62
 - Select services..... 51
 - Sender's address (e-mail)..... 87
 - Sending
 - directory entry to handset..... 63
 - Server..... 168
 - Services
 - online directory..... 136
 - Setting
 - online directory..... 136
 - Setting melody (ringer)..... 102
 - Setting the date..... 105
 - Setting the time..... 105
 - Setting the wake-up time..... 93
 - Setting up
 - handset..... 11
 - Setting up, base..... 16, 17
 - Shortcut..... 61, 63
 - Silence, suppressing..... 131
 - Simple Transversal of UDP over NAT... 169
 - SIP..... 168
 - SIP address..... 169
 - SIP port..... 169
 - SIP provider..... 169
 - SIP proxy server..... 169
 - SMS..... 74
 - active send service centre..... 80
 - answering or forwarding..... 79
 - deleting..... 76, 79
 - draft message list..... 75
 - forwarding..... 79
 - inbox..... 58, 78
 - notification via SMS..... 80
 - reading..... 76, 79
 - receiving..... 77
 - saving number..... 79
 - self help with error messages..... 83
 - sending as fax..... 77
 - sending to e-mail address..... 77
 - status report..... 75
 - to PABXs..... 81
 - troubleshooting..... 83
 - writing..... 74, 157
 - SMS centre
 - changing number..... 80
 - setting..... 80
 - Snooze mode..... 93
 - Sound, see Ringtone
 - Special functions..... 113
 - Specifications..... 155
 - Speech pauses, suppressing..... 131
 - Star key..... 5
 - Static IP address..... 169
 - Status codes (VoIP)
 - codes table..... 149
 - Structure of IP address..... 165
 - Structure of Web pages..... 121
 - STUN..... 169
 - Subject (e-mail), reading..... 87
 - Subnet..... 169
 - Subnet mask..... 169
 - defining..... 107
 - Symmetric NAT..... 169
 - System settings
 - securing..... 105
- T**
- TCP..... 169
 - Telephone care..... 155
 - Telephone jack
 - pin connections..... 157
 - Text message, see SMS
 - Three-party conference..... 56
 - Time control (night mode)..... 103
 - TLS..... 169
 - Tone dialling..... 113, 115
 - Transmission Control Protocol..... 169
 - Transmission rate..... 169
 - Transport Layer Security..... 169
 - Transport protocol..... 170
 - Troubleshooting
 - e-mail..... 86
 - Troubleshooting (SMS)..... 83

Index

U

UDP.....	170
Uniform Resource Identifier	170
Universal Resource Locator	170
Unknown.....	47
Unknown caller	47
URI.....	170
URL	170
User data (VoIP), entering	
with handset	28
User Datagram Protocol	170
User ID	170
Username	170

V

vCard format.....	138
vcf file.....	137
Version check	
automatic	130, 140
Voice over Internet Protocol.....	170
VoIP.....	170
configuring account (first)	28
loading provider data	27
show called party's number.....	45
status codes (table)	149
VoIP provider	170
downloading data	27
selecting	27
VoIP status messages	
status codes table.....	149
VoIP user data	
entering (connection wizard)	28
Volume	
earpiece.....	101
handset handsfree volume.....	101
ringtone.....	102
speaker	101

W

WAN	171
Web configurator	
connecting with PC	117
de-registering	120
DTMF signalling for VoIP.....	134
interface language.....	119
menu	125
Web page	
structure	121
Wide Area Network.....	171
Withholding	
phone number display	51
suppressing speech pauses (VoIP) ...	131
Withholding number.....	51
Working area	122
Writing (SMS)	74
Writing and editing text	157

Y

Yellow Pages.....	64
-------------------	----

Issued by

Gigaset Communications GmbH
Frankenstr. 2a, D-46395 Bocholt

© Gigaset Communications GmbH 2011

All rights reserved. Subject to availability.

Rights of modification reserved.

www.gigaset.com