

# KRONOS

MUSIC WORKSTATION

## Operation Guide

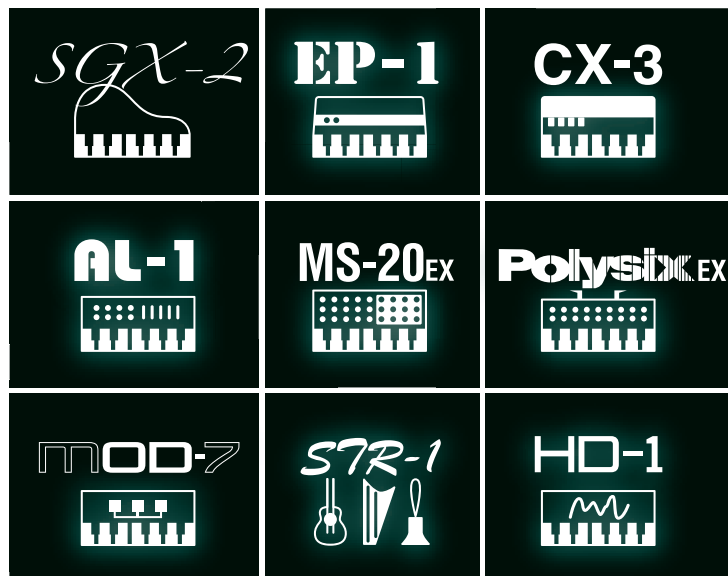

SONDIUS-XG

GENERAL  
MIDI

  
KARMA

KARMA® (Kay Algorithmic Realtime Music Architecture) and the KARMA Logo are registered trademarks representing patented technology licensed from Stephen Kay, Karma Lab LLC, [www.karma-lab.com](http://www.karma-lab.com).

  
Multi-Dimensional  
Synthesis

*SST*  
Smooth Sound  
Transitions

*CMT*

*REMS*

 TouchView  
Graphical User Interface

# KORG



---

Thank you for purchasing the Korg KRONOS. To help you get the most out of your new instrument, please read this manual carefully.

## About this manual

### The owner's manuals and how to use them

#### References to different KRONOS models

These manuals apply to all KRONOS models running software version 3.0 or later, collectively referred to as “the KRONOS.” The front panel and rear panel illustrations show the KRONOS2-61, but they apply identically to the KRONOS and KRONOS X.

#### Three manuals

The KRONOS includes three owner's manuals:

- Quick Start Guide
- Operation Guide
- Parameter Guide

All of these manuals are available as PDFs on Accessory Disc 3, and are included in the on-board Help system. A printed version of the Quick Start Guide is also included.

#### Quick Start Guide

Please read this first. It introduces all of the basic features of the KRONOS, and is designed to get you up and running quickly.

#### Operation Guide

Put simply, the Operation Guide is designed to answer the question, “How do I do this?”

It explains the names and functions of each part of the KRONOS, basic operation, an overview of each mode, how to edit sounds, record on the sequencer, sample, and so on. This guide also explains the basics of effects, KARMA, Drum Track, Wave Sequences, and Drum Kits.

Finally, it also contains a troubleshooting guide and supplemental information such as specifications.

#### Parameter Guide

The Parameter Guide is designed to answer the question, “What does this do?”

Organized by mode and page, the Parameter Guide includes information on each and every parameter in the KRONOS.

#### PDF versions

The KRONOS PDF manuals are designed for easy navigation and searching. They include extensive PDF contents information, which generally appears on the side of the window in your PDF reader and lets you jump quickly to a specific section. All cross-references are hyper-links, so that clicking on them automatically takes you to the source of the reference.

#### On-board Help system\*

The HELP button gives you built-in, context-sensitive access to the user manuals, right from the front panel.

For information on any front-panel button, knob, slider, or real-time controller, just hold down HELP and then press the button or move the controller in question.

For information on the current LCD page, press and release the HELP button.

For more details on using the Help system, see “HELP button” on page 3.

\*English-language only.

## Supplementary guides

### Voice Name List

The Voice Name List lists all of the sounds and setups that are in the KRONOS when it is shipped from the factory, including Programs, Combinations, Multisamples, Drumsamples, Drum Kits, KARMA GEs, Wave Sequences, Drum Track Patterns, Template Songs, and Effect Presets.

### Updating and restoring the KRONOS

This document contains information on updating and restoring the KRONOS software. It's provided separately as a convenience; all of its information may also be found in the Parameter Guide.

## Conventions in this manual

### Abbreviations for the manuals: OG, PG, VNL

In the documentation, references to the manuals are abbreviated as follows.

**QS:** Quick Start Guide

**OG:** Operation Guide

**PG:** Parameter Guide

**VNL:** The Voice Name List

### Symbols , , Note, Tips

These symbols respectively indicate a caution, a MIDI-related explanation, a supplementary note, or a tip.

### Example screen displays

The parameter values shown in the example screens of this manual are only for explanatory purposes, and may not necessarily match the values that appear in the LCD screen of your instrument.

### MIDI-related explanations

CC# is an abbreviation for Control Change Number.

In explanations of MIDI messages, numbers in square brackets [ ] always indicate hexadecimal numbers.

- 
- \* KARMA<sup>®</sup> (Kay Algorithmic Realtime Music Architecture) Technology has been licensed from Stephen Kay, and is protected by U.S. Patents 6,084,171, 6,087,578, 6,103,964, 6,121,532, 6,121,533, 6,326,538, 6,639,141, 7,169,997, and 7,342,166.
  - \* KARMA<sup>®</sup> and the KARMA Logo are registered trademarks, and Kay Algorithmic Realtime Music Architecture, Generated Effect (GE), Melodic Repeat, Direct Index, Manual Advance, SmartScan, Freeze Randomize, Random Capture, Random FF/REW and Scene Matrix are trademarks of Stephen Kay, Karma-Lab LLC. This manual copyright © 1994-2014 by Korg Inc. and Stephen Kay. All rights reserved.
  - \* Screen shots from the KARMA software that appear throughout this guide are © 1994-2014 by Stephen Kay, Karma Lab LLC. Used by permission. All rights reserved.
  - \* KARMA Technology can be located on the internet at: [www.karma-lab.com](http://www.karma-lab.com).
  - \* This product was developed under license of physical modeling tone generator patents (<http://www.sondius-xg.com>) owned by Stanford University USA and Yamaha Corporation.
  - \* Linux is a trademark or registered trademark of Linus Torvalds in the United States and in other countries.
  - \* All product names and company names are the trademarks or registered trademarks of their respective owners.

# Contents

<b>About this manual</b> .....	<b>iii</b>
--------------------------------	------------

---

## **Introduction to KRONOS** .....

### **Front and rear panels**.....

Front panel .....	1
Rear panel .....	8
TouchView user interface .....	10

### **Basic information** .....

About the KRONOS' modes .....	13
About the KRONOS' PCM memory .....	16
About polyphony .....	16
Basic operations .....	17

### **Setup** .....

Turning the power on/off .....	20
Connections .....	21

### **Update information** .....

New features in software version 3.0 .....	26
New features in software version 2.1 .....	27
New features in software version 2.0 .....	28
New features in software version 1.5 .....	28

---

## **Playing and editing Programs** .....

### **Playing Programs** .....

Selecting Programs .....	31
Using Controllers .....	35
Using the Chord Pads .....	39
Using Chord mode .....	40

### **Easy Program Editing**.....

Quick edits using the knobs, sliders, and switches .....	43
--	----

### **Detailed Program Editing**.....

Editing HD-1 Programs .....	47
Using LFOs and Envelopes (EGs) .....	50
Using Alternate Modulation (AMS) and the AMS Mixers .....	51
Controlling Pitch .....	52
Using Filters .....	53
Using the Amp section .....	56
Using EXi .....	58
Using Vector Synthesis .....	60
Effects .....	62
Automatically importing a Program into Sequencer mode .....	62

---

## **Playing and editing Combinations** ....

### **Playing Combinations** .....

Selecting Combinations .....	63
------------------------------	----

### **Easy Combination editing** .....

Changing the Programs within a Combi .....	66
Adjusting the mix .....	66
Easy KARMA editing .....	67

### **Detailed Combination editing**.....

Combination overview .....	68
Layers, Splits, and Velocity Switches .....	69
MIDI Settings .....	70
Altering Programs to fit within a Combination .....	71
Editing Programs from within a Combination or Song .....	72
Effects .....	73
Automatically importing a Combination into Sequencer mode .....	73
Saving your edits .....	74

---

## **Creating songs (Sequencer mode)** ....

### **Sequencer overview**.....

About the KRONOS' sequencer .....	75
Sequencer mode structure .....	75

### **Playing Songs**.....

Playback .....	78
The control surface in Sequencer mode .....	80

### **MIDI recording** .....

Preparations for recording .....	82
Recording MIDI in real-time .....	84
MIDI step recording .....	87
Recording the sound of a Combination or Program .....	88
Recording multiple MIDI tracks from an external sequencer .....	90
Recording System Exclusive events .....	91
Recording patterns .....	92
Other ways to record .....	94

### **Audio recording**.....

Audio recording overview .....	95
Audio input settings and recording source selection .....	96
Recording procedure .....	99
Other variations of audio track recording .....	105
Placing a WAVE file in an audio track .....	107

### **Song editing** .....

Songs .....	109
MIDI Tracks .....	109
Common to MIDI tracks and audio tracks .....	110
Audio Tracks .....	111

### **Using RPPR (Realtime Pattern Play/Record)** ..

Creating RPPR data .....	112
RPPR playback .....	113
Recording an RPPR performance .....	113

### **Sampling in Sequencer mode** .....

### **Saving your Song** .....

### **Other notes about Sequencer mode** .....

KRONOS sequencer file formats .....	117
The Compare function .....	117
Memory Protect .....	118
About MIDI .....	118

---

**Set Lists ..... 119****Set List Overview ..... 119****Selecting and playing sounds ..... 120**

- Selecting Set Lists ..... 120
- Selecting Slots ..... 121
- Using the Comment Pad ..... 122

**Editing Set Lists ..... 123**

- Selecting and re-arranging sounds ..... 123
- Detailed Set List editing ..... 124
- Set Lists and the Control Surface ..... 126

**Smooth Sound Transitions ..... 128**

- Overview ..... 128
- Using Smooth Sound Transitions ..... 128

---

**Sampling (Open Sampling System) .. 131****Sampling overview ..... 131**

- About sampling on the KRONOS ..... 131

**Preparations for sampling ..... 134**

- Audio Settings ..... 134

**Sampling and editing in Sampling mode .... 140**

- Creating multisample indexes and sampling-P0: Recording ..... 141
- Basic examples of sampling ..... 143
- Editing loops ..... 147
- Using Time Slice ..... 149
- Sample waveform editing ..... 152
- Multisample editing ..... 153
- Sampling from an Audio CD ..... 153
- Saving, converting to Programs, and Comparing... 154

**Sampling in Program and Combination modes ..... 156**

- Overview ..... 156
- Resampling a KARMA phrase in Program mode ... 156
- Auto Sampling Setup ..... 157
- Mixing a KARMA drum phrase with a live guitar input, and sampling the result..... 157
- Sampling a guitar from the audio inputs, while listening to a KARMA drum phrase ..... 158

**Sampling in Sequencer mode ..... 159**

- In-Track Sampling ..... 159
- Resampling a song to create a Wave file ..... 160

**User Sample Banks ..... 162**

- Overview ..... 162
- Saving User Sample Banks ..... 162
- Loading User Sample Banks ..... 164
- Editing User Sample Banks ..... 164
- User Sample Bank IDs and limitations ..... 165

---

**Global Settings, Wave Seq., Drum Kits ..... 167****Global mode overview ..... 167****Global Settings ..... 168**

- Basic Setup ..... 168

- Global audio settings ..... 170

- MIDI settings ..... 170

- Pedal and other controller settings ..... 171

- Creating user scales ..... 172

- Setting Category Names for Programs, Combinations, and KARMA ..... 173

**Automatically loading sample data ..... 174**

- Using the KSC Auto-Load list to select which samples to load ..... 174
- Creating and saving .KSC files ..... 175

**Connecting to computers via USB Ethernet and FTP ..... 177****Using Wave Sequences ..... 178**

- Wave Sequence Overview ..... 178
- Programming Basics ..... 179
- Adjusting the sound of an individual step ..... 180
- Using rhythmic Wave Sequences ..... 181
- Creating smooth, evolving timbres ..... 183
- Modulating Wave Sequences ..... 184
- Saving Wave Sequences ..... 185

**Using Drum Kits ..... 186**

- Drum Kit Overview ..... 186
- Before you start editing... ..... 186
- Editing Drum Kits ..... 187
- Saving Drum Kits ..... 189

---

**Loading & saving data, and creating CDs ..... 191****Saving data ..... 191**

- Overview ..... 191
- Writing to internal memory ..... 192
- Saving to disks, CDs, and USB media ..... 196

**Loading data from disk ..... 200**

- Loading Songs, sounds, samples, and KARMA GEs together ..... 200
- Loading individual banks from a .PCG file ..... 203
- Loading data by individual item or bank ..... 203
- Loading the samples required by Programs or Combinations ..... 204

**Creating and playing audio CDs ..... 206**

- Creating audio CDs ..... 206
- Playing audio CDs ..... 208

**Other disk operations ..... 209**

- Setting the date and time ..... 209

---

**Using Effects ..... 211****Effects overview ..... 211**

- Effects basics ..... 211
- Effect I/O ..... 212
- Effects in each mode ..... 212

**Effects selection and routing ..... 214**

- Using effects in Programs ..... 214
- Using effects in Combinations and Songs ..... 216
- Using effects in Sampling mode ..... 218
- Using effects with the audio inputs ..... 219

<b>Detailed effects editing</b> .....	<b>221</b>
Dynamic modulation (Dmod).....	221
MIDI/Tempo Sync.....	221
Common FX LFO.....	222
Effect Presets.....	223

---

## **Using KARMA .....225**

### **Overview - What is KARMA?..... 225**

The structure of KARMA.....	225
-----------------------------	-----

### **Performing with KARMA..... 229**

Performing with KARMA in Program mode.....	229
Performing with KARMA in Combination mode.....	232

### **Editing KARMA ..... 235**

Editing KARMA in Program mode.....	235
Editing KARMA in Combination mode.....	239

### **Using KARMA in Sequencer mode ..... 244**

Auto Song Setup.....	244
Recording using KARMA (single-track recording).....	245
Multi-track recording using settings copied from a Combination.....	246

### **Synchronizing KARMA..... 247**

Synchronization basics.....	247
The “Quantize Trigger” parameter.....	247
Slave operation.....	248
Master operation.....	248

---

## **Using the Drum Track .....249**

### **Overview ..... 249**

What is the Drum Track?.....	249
------------------------------	-----

### **Performing with the Drum Track ..... 250**

Using the Drum Track in Program mode.....	250
Using the Drum Track in Combination mode.....	252

### **Drum Track settings..... 253**

Drum Track settings in Program mode.....	253
Drum Track settings in Combination mode.....	254
Drum Track settings in Sequencer mode.....	254
Using KARMA and the Drum Track together.....	255
Synchronizing the Drum Track.....	256

### **Creating Drum Track patterns..... 257**

Preparing a user pattern.....	257
Converting a Sequencer pattern to a Drum Track pattern.....	257

---

## **Appendices .....259**

### **Troubleshooting ..... 259**

Power supply.....	259
LCD screen.....	259
Audio input and output.....	260
Programs and Combinations.....	261
Songs.....	262
Set Lists.....	263
Sampling.....	264
KARMA.....	265
Drum Track.....	265

Vector.....	265
Drum Kits.....	265
Wave Sequences.....	266
Effects.....	266
MIDI.....	266
Disks, CDs, and USB Media.....	266
Other problems.....	267

### **Error and confirmation messages.....268**

A (ADC–Are You Sure).....	268
B (Buffer).....	268
C (Can’t calibrate–Completed).....	268
D (Destination–Disk).....	269
E (Error–Exceeded).....	270
F (File–Front).....	271
H.....	272
I (Illegal–Index).....	272
K.....	273
M (Master–Multisample).....	273
N (No data–Not enough song memory).....	274
O (Obey copyright rules–Oscillator).....	276
P (Pattern–Program).....	276
R (Rear sample–Root).....	276
S (Sample–Source).....	277
T (The clock–/TEMP folder detected).....	277
U (Unable to create directory–USB Hub).....	278
W (Wave).....	278
Y (You).....	279

### **Disk and Media information.....280**

Types of media supported by the KRONOS.....	280
Operations that the KRONOS can perform on media.....	280
Restoring the factory settings.....	281

### **Specifications .....282**

### **MIDI Implementation Chart .....288**





# Introduction to KRONOS

## Front and rear panels

### Front panel

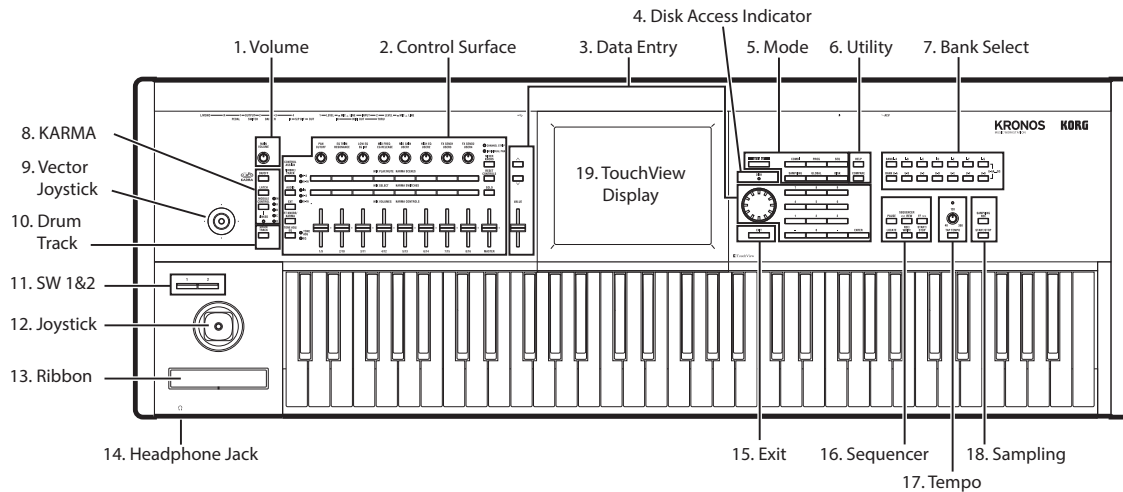

#### 1. MAIN VOLUME knob

This adjusts the volume of the main L/R audio outputs, as well as the volume of the headphone jack.

It does not affect any of the other audio outputs, including S/P DIF, individual outputs 1-4, or the USB output.

#### 2. Control Surface

The Control Surface is the set of 9 sliders, 8 knobs, and 16 switches to the left of the LCD screen. It looks like a mixer, but can do a variety of things such as editing sounds, controlling KARMA, and sending MIDI messages to external devices. You can freely change back and forth between the different functions without losing any of your edits.

#### CONTROL ASSIGN buttons

As explained below, you can use the front panel CONTROL ASSIGN buttons to switch between the various control surface functions. You can also view and edit the control surface settings on the LCD screen (P0– Control Surface page in each mode).

#### TIMBRE/TRACK

**TIMBRE/TRACK** lets you use the control surface to adjust the volume, pan, EQ, and send levels for OSC 1/2, EXi 1/2, or the Drum Track in Program mode, the current Multisample in Sample mode, and each of the 16 Timbres or Tracks in Combi and Sequence modes.

The LEDs to the right of the switch show whether you're currently editing Timbres (or Tracks) 1-8 or 9-16; press the **TIMBRE/TRACK** button to toggle between the two.

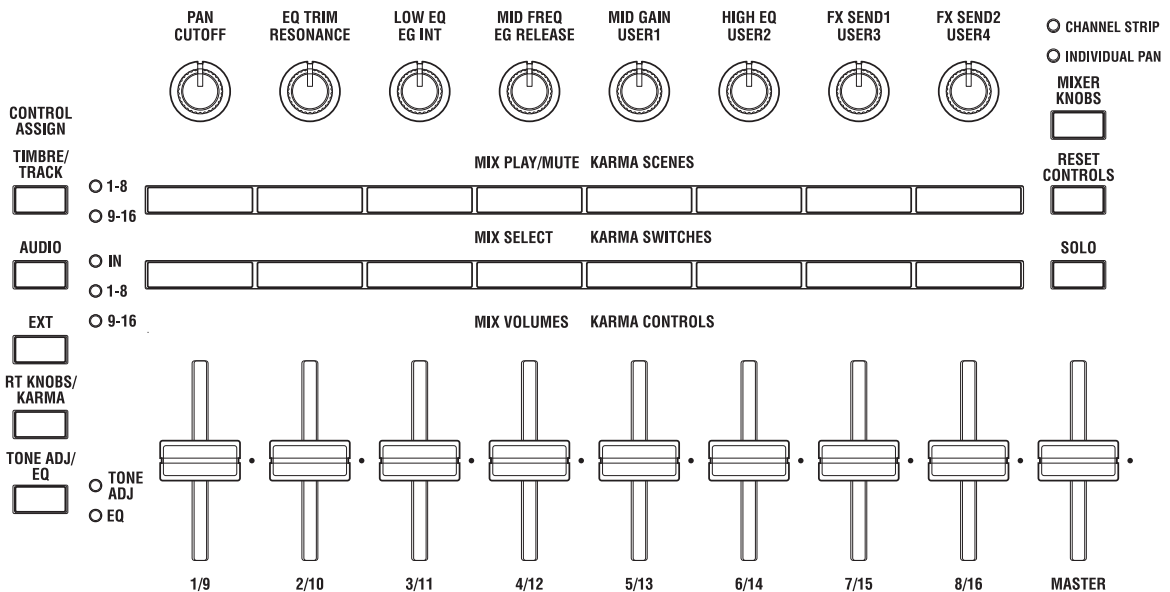

If you switch to one of the other Control Assign modes, and then go back to **TIMBRE/TRACK**, it will automatically return to the previously selected group (1-8 or 9-16).

**AUDIO**

**AUDIO** lets you use the control surface to adjust the volume, play/mute status, solo, pan, and send levels of the analog, S/P DIF, and USB audio inputs. In Sequencer mode, you can also choose to control audio tracks 1–8 (HDR 1-8) or 9–16 (HDR 9-16).

As with **TIMBRE/TRACK**, if you switch to one of the other Control Assign modes, and then go back to **AUDIO**, it will automatically return to the previously selected group (Inputs, HDR 1-8 or HDR 9-16).

**EXT**

**EXT** (External) lets you use the control surface to transmit MIDI messages to external MIDI devices.

**RT KNOBS/KARMA**

**RT KNOBS/KARMA** lets you modulate sounds and effects with the knobs, and control KARMA with the sliders and switches.

**TONE ADJ/EQ**

**TONE ADJ** (Tone Adjust) gives you hands-on access to sound editing, using the sliders, knobs, and switches. In Combi and Sequence modes, it also lets you edit Programs within the context of the Combi or Song, without making any changes to the original Program data.

**EQ** is available only in Set Lists. This is a nine-band graphic EQ applied to the sound after TFX2, which tailors the sound from the main stereo outputs (including the analog L/R outputs, S/P DIF, and USB).

You can use this EQ to compensate for the acoustic environment of a specific club or other performance venue. The sliders are mapped to the nine bands of the EQ, for quick and intuitive adjustments.

**More information on the Control Surface**

For more information on how the Control Surface works in the different modes, see:

- Program mode: “0–9: Control Surface” on page 21 of the Parameter Guide
- Combi mode: “0–9: Control Surface” on page 432 of the Parameter Guide
- Sequence mode: “0–9: Control Surface” on page 538 of the Parameter Guide

**MIXER KNOBS button**

This applies only when **CONTROL ASSIGN** is set to **TIMBRE/TRACK** or **AUDIO**. It toggles the knobs between controlling the pan of all channels or controlling the pan, EQ, and sends of the currently selected channel.

**RESET CONTROLS button**

This feature lets you reset the Vector Joystick to the center position, or reset any of the Control Surface sliders, knobs, or switches to their saved value.

To reset a single control, hold down **RESET CONTROLS** and then move a Control Surface slider or knob, press one of the control surface buttons, or move the Vector Joystick.

To reset all of the sliders, knobs, and switches of the current **CONTROL ASSIGN** mode at once, hold down **RESET CONTROLS** and then press the currently-lit **CONTROL ASSIGN** button again.

You can also reset all of the sliders and switches in the KARMA Module by holding **RESET CONTROLS** and then pressing the **KARMA MODULE CONTROL** button. Similarly, to reset a single KARMA Scene, hold **RESET CONTROLS** and press any of the **SCENE** buttons.

Finally, you can also use this to clear all solos, by holding **RESET CONTROLS** and then pressing the **SOLO** button.

For more information, see “**RESET CONTROLS**” on page 22 of the Parameter Guide.

**SOLO button**

This applies only when **CONTROL ASSIGN** is set to **TIMBRE/TRACK** or **AUDIO**. It toggles the **SELECT** buttons between selecting the current Oscillator, Timbre, Track, or Audio Input (when **SOLO** is off) or soloing the channel (when **SOLO** is on).

For more information on **SOLO** in the various modes, see:



**Programs:** “**SOLO** switch and **SELECT** switches 1–3” on page 23 of the Parameter Guide

**Combinations:** “**Solo** switch and **Select** switches 1–8” on page 434 of the Parameter Guide

**Sequencer:** “**Solo** switch and **Select** switches 1/9–8/16” on page 540 of the Parameter Guide

**3. Data entry**

When you’ve selected a parameter on the TouchView display, you can edit it using any of the four front-panel data entry controls:

- The **VALUE** slider
- The **Inc**  and **Dec**  buttons
- The **VALUE** dial
- The numeric keypad

**VALUE slider**

Use this to edit the selected parameter’s value. This control is convenient for making large changes to the value, such as moving quickly to the minimum or maximum setting.

You can also use the **VALUE** slider as a modulation source, but only when the following are true:

- You’re on the Program mode P0–Main page, and the big Program name is selected, or
- You’re on the Combination mode P0– Prog Select/Mixer page, and the big Combination name is selected.
- You’re on the Set List P0–Play page.

In these cases only, the **VALUE** slider sends MIDI CC#18, and can be used as a modulation source.



**Inc  and Dec  buttons**

These are used to increase or decrease the parameter value by individual steps. They’re convenient for making fine parameter adjustments.

**VALUE dial**

Use this dial to edit the selected parameter’s value. This control is convenient when you want to scroll through a very long list of selections.

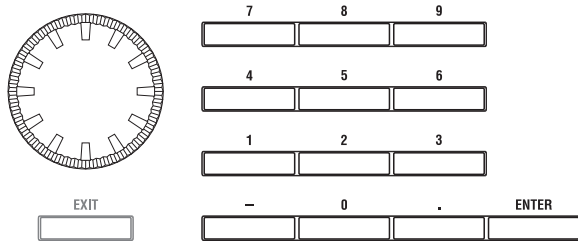

**0-9, -, ., and ENTER buttons**

These buttons are convenient when you know the exact value that you want to enter. Use the 0–9, –, and decimal (.) buttons to enter the value, and then press the ENTER button to confirm the entry.

The – button inverts the sign (+/–) of the parameter value; the decimal (.) button inserts a decimal, for entering fractional values.

**Special functions of the ENTER button**

ENTER has a few special functions when it is pressed in combination with other buttons.

Whenever an on-screen parameter lets you enter a musical note (such as G4 or C#2), or a velocity level, you can enter the note or velocity directly by holding down ENTER while playing a note on the keyboard.

By holding down the ENTER button while you press a numeric button (0–9), you can select the first ten menu commands from the current page.

In Program and Combination modes, you can hold down the ENTER button and press the SEQUENCER REC/WRITE button to use the Auto Song Setup function. This imports the current Program or Combi into Sequence mode for quick and easy recording.

You can use ENTER to jump into the editing pages of a Program from within a Combination or Song—while still hearing all of the other Timbres or Tracks. To do so, go to the Prog Select/Mixer page, hold down the ENTER button, and touch the Program select field in the display. For more information, see “Editing Programs from within a Combination or Song” on page 72.

**4. DISK access indicator**

This LED lights up when data is being saved to or read from the internal disk.

 Never turn off the power while this LED is lit. Doing so can cause all or part of the data on the disk to be lost, or may cause malfunctions such as disk damage.

**5. MODE buttons**

KRONOS has seven different operational modes, each one optimized for a specific set of functions. These buttons select the current mode.

Each button has an LED, which lights up to show the mode you’ve selected.

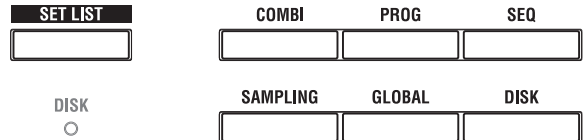

**SET LIST button**

This selects Set List mode. Set Lists make it simple to play and organize any of the sounds loaded into the KRONOS, without regard for what bank they’re stored in or whether they’re Programs, Combinations, or even Songs.

**COMBI button**

This selects Combination mode, for playing and editing complex splits and layers of Programs.

**PROG button**

This selects Program mode, for playing and editing basic sounds.

**SEQ button**

This selects Sequencer mode, for recording, playing, and editing audio and MIDI tracks.

**SAMPLING button**

This selects Sampling mode, for recording and editing audio samples and multisamples.

**GLOBAL button**

This selects Global mode, for making overall settings, editing Wave Sequences and Drum Kits, and more.

**DISK button**

This selects Disk mode, for saving and loading data to and from the internal disk or external USB 2.0 storage devices. You can also create audio CDs using a USB CD-R drive (not included).

**6. UTILITY buttons**

**HELP button**

The HELP button gives you built-in, context-sensitive access to the user manuals, right from the front panel.



For information on any front-panel button, knob, slider, or real-time controller, just hold down HELP and then press the button or move the controller in question.



For information on the current LCD page, press and release the HELP button.

While the help page is on the screen, you can touch any of the on-screen links (highlighted in blue text) for more information. You can scroll through the text by using the on-screen scroll bars, pressing the Inc and Dec buttons, or spinning the Value dial.

The top of the Help page has “breadcrumb” links, which show the hierarchy of pages above the current one. Touch any of these links to jump to the corresponding page.

The backwards and forwards buttons function like the similar buttons on a standard web browser. If you use links to jump between pages, you can then use the backwards and forwards buttons to move through the pages you’ve already viewed.

The Contents page lets you access any part of the Help system, including almost all of the text and graphics in both the Parameter and Operation Guides. The Index contains a shorter list of links to important articles.

To close the help display, just press the HELP button again, press the EXIT button, or press the on-screen **Done** button.

**COMPARE button**

Use this button to compare the sound of the Program or Combination that you are currently editing with the saved, un-edited version of the sound. You can also use this button to make “before and after” comparisons when recording or editing in Sequencer mode.

**7. BANK SELECT buttons**

Use these buttons to change banks when selecting Programs or Combinations. The LEDs in the buttons light up to show the current bank.

To select Program banks U-AA...GG, press both the INT and USER buttons simultaneously. For instance, to select USER-DD, press both I-D and U-D.

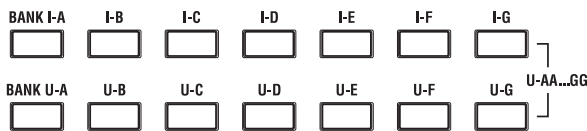

In Program mode, these buttons select the Program bank. They are active only on the Play pages.

In Combination mode, these buttons have two functions:

- When you’re selecting Combinations, they choose the Combination bank.
- When you’re assigning a Program to a timbre within the Combi, they select the Program bank.

In Sequencer mode, when a track’s Program name is selected, these buttons change the Program bank.

**General MIDI banks**

Selecting General MIDI Program banks is a little different from selecting other banks. Each time you press the INT-G button, the bank will step to the next GM(2) bank or GM drum bank in the following order: G, g(1), g(2)–g(8), g(9), g(d), G, g(1), etc.

**What’s in each bank?**

For details on the contents of the Program banks, see “Program bank contents” on page 31. For details on the Combi banks, see “Combination bank contents” on page 63.

**8. KARMA buttons**

KARMA stands for “Kay Algorithmic Realtime Music Architecture.” It’s an immensely powerful recording and live performance tool, which can provide a wide range of musical effects including:

- Arpeggiation
- Drum and instrument grooves

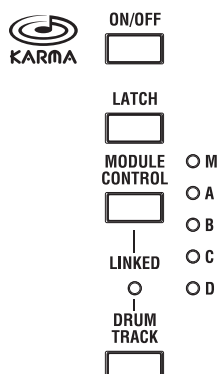

- Complex CC gestures (as if it was automatically moving knobs or joysticks for you)
- Musical phrase generation
- Gated and chopped dance production effects
- Any combination of the above
- ...and much more.

**ON/OFF button**

This switches KARMA on and off. As with the other KARMA buttons, the button’s LED will light up to show you that it is turned on.

**LATCH button**

When LATCH is turned on, KARMA will continue to play even after you’ve stopped holding notes on the keyboard or MIDI In.

This is convenient when you want to play on top of a KARMA-generated groove, for instance.

**MODULE CONTROL button**

In Combi and Sequencer modes, KARMA has four independent Modules, each of which can be generating a different musical effect. When used to control KARMA, the Control Surface sliders and switches are five layers deep: one for each Module (A-D), and then a Master Layer which controls selected parameters from all of the Modules at once.

The **MODULE CONTROL** button selects whether the KARMA SLIDERS, SWITCHES, and SCENES will control either a single Module independently, or the Master Layer. In Program mode, only a single Module is available, and the Master Layer is used to control it; you cannot select other settings).

**9. Vector Joystick**

The Vector Joystick is a powerful real-time controller. Depending on the particular Program, Combi, or Song, it may modulate Program or effects parameters, or adjust the volumes of different components of the sound.

For more information on how Vector Synthesis works, see “Using Vector Synthesis” on page 60.

**10. Drum Track**

The Drum Track is a built-in drum machine, fueled by the KRONOS’s high-quality drum sounds. This button turns the Drum Track on and off.

Depending on various settings, the Drum Track may begin to play immediately, or may wait until you start to play on the keyboard. If the button’s LED is blinking on and off, it’s waiting for you to play.

**LINKED LED**

If the front panel LINKED LED and KARMA ON/OFF switches are lit, KARMA will start and stop together with the Drum Track. For more information, see “Using KARMA and the Drum Track together” on page 255.

**11. SW1 and SW2**

These on/off switches can perform a number of different functions, such as modulating sounds or locking the modulation values of the joystick, ribbon, or aftertouch.

Also, each one may work either as a toggle, or as a momentary switch. In toggle mode, each press alternates between on and off; in momentary mode, the switch only changes for as long as you hold it down.

Each switch has an LED, which lights up when the switch is on.

Each Program, Combination, and Song stores its own settings for what the switches will do, and whether each switch defaults to being on or off.

## 12. Joystick

The joystick moves in four directions: left, right, forwards (away from yourself), and backwards (towards yourself). Each of the four directions can be used to control different program or effects parameters.

The specific assignments can change depending on the current Program, Combi, or Song. Generally, though, they will do something like the functions shown below:

Move the joystick...	Controller Name	Normally controls...
Left	JS-X	Pitch bend down
Right	JS+X	Pitch bend up
Forwards (away from yourself)	JS+Y	Vibrato
Backwards (towards yourself)	JS-Y	Filter LFO (wah)

## 13. Ribbon controller

The Ribbon controller lets you modulate Program or effects parameters by sliding your finger left and right along its touch-sensitive strip.

As with the other controllers, its specific function will change depending on the current Program, Combi, or Song.

## 14. Headphone jack

This stereo 1/4" headphone jack carries the same signal as the Main L/R outputs.

The headphone volume is controlled by the MAIN VOLUME knob.

## 15. EXIT button

This button makes it easy to return to the main page of the current mode:

- Press it once to go to the previously-selected tab on the main P0 page.
- Press it again to go to the first tab on the main P0 page (such as the main Program Play page). If you had previously selected a parameter on this page, that parameter will be selected.
- Press it a third time to select the main parameter on the P0 page, such as the Program name in Program mode.

Wherever you are in Program, Combi, or Sequencer modes, pressing EXIT three times (or fewer) will take you back to Program/Combination/Song Select, where you can immediately use the numeric keys or  $\wedge/\vee$  switches to select a Program, Combination, or Song.

When a dialog box is open, this button cancels the settings made in the dialog box and closes the dialog box, just like pressing the Cancel button. If a popup menu or page menu is open, pressing EXIT closes the menu.

## 16. SEQUENCER buttons

Most of the buttons in this section apply only to Sequencer mode and, in Disk and Sampling modes, to audio CD playback from a connected USB CD drive.

REC/WRITE is the exception; it has special functions in Program, Combination, and Global modes, as described below.

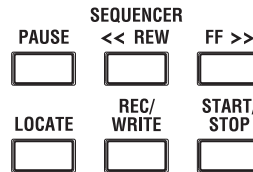

### PAUSE button

In Sequencer mode, this button pauses the playback of the song. When paused, the button's LED will light up. Press PAUSE once again to resume playback, and the LED will turn off.

In Disk and Sampling modes, this button pauses audio CD playback.

### <<REW button

In Sequencer mode, when the Song is playing or paused, this button will rewind the song. When you press and hold this button, its LED will light up, and the playback will rewind. (Rewind is disabled during recording, and while the Song is stopped.)

In Disk and Sampling modes, this button rewinds the audio CD.

### FF>> button

In Sequencer mode, when the Song is playing or paused, this button will fast-forward the song. When you press and hold this button, the button will light, and the playback will fast-forward. (Fast-forward is disabled during recording, and while the Song is stopped.)

In Disk and Sampling modes, this button fast-forwards the audio CD.

### LOCATE button

In Sequencer mode, this button will advance or rewind the song to the specified locate point. This lets you jump immediately to any point in the current Song. The default locate point is the first beat of measure 1.

To set the locate point to the current position, hold down ENTER and then press LOCATE. You can also set the Locate point directly via the on-screen menu.

### REC/WRITE button

In Sequencer mode, pressing this button will enter record-ready mode. Once you're in record-ready mode (shown by the button's lit LED), you can begin recording by pressing the SEQUENCER START/STOP button. For more information, see "Recording MIDI in real-time" on page 84.



In Program, Combination, Set List, and Global modes, pressing REC/WRITE will open the Save dialog box. For more details, see “Writing to internal memory” on page 192, and “Using the SEQUENCER REC/WRITE button” on page 192.

In Program and Combination modes, you can hold down the ENTER button and press the SEQUENCER REC/WRITE button to use the Auto Song Setup function. This imports the current Program or Combi into Sequence mode for quick and easy recording. For more information, see “Auto-Song Setup” on page 2 of the Parameter Guide.

**START/STOP button**

This starts or stops recording and playback in Sequencer mode.

In Disk and Sampling modes, this button starts and stops playback on the audio CD.

**17. TEMPO controls**

**TEMPO knob**

This knob adjusts the tempo for the KRONOS as a whole, including Songs, KARMA, the Drum Track, Tempo-synced LFOs and BPM delays, and EXi Step Sequencers.

The LED will blink at quarter-note intervals of the current tempo.

*Note:* If the GLOBAL MIDI page **MIDI CLOCK** parameter is set to **External MIDI or USB**, or if it is set to **Auto** and a clock is currently being received, then neither the TEMPO Knob nor the TAP TEMPO button will have any effect.

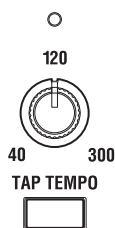

**TAP TEMPO button**

This button lets you enter tempos simply by tapping your finger on the button. You can use this interchangeably with the “TEMPO knob,” above. Two taps are enough to change the tempo; for greater accuracy, you can continue tapping, and the tempo will be averaged over the most recent 16 taps.

For example, you can use TAP TEMPO to control the KARMA tempo:

- In Program mode or Combination mode, start KARMA running.**

Turn on the KARMA ON/OFF switch, and play a key or a pad. If you turn on the LATCH switch, KARMA will continue playing even after you lift up your hands.

- Lightly press the TAP TEMPO switch several times at the desired tempo.**

Notice that the “♩=” in the upper right of the LCD screen will change to show the new tempo.

If you press the TAP TEMPO switch at shorter intervals, the playback tempo will become correspondingly faster.

*Note:* You can also tap tempos using a foot switch. For more information, see “Foot Switch Assignments” on page 1111 of the Parameter Guide.

**18. SAMPLING buttons**

**REC button**

In Sampling, Program, Combination, and Sequencer modes, pressing this button enters the initial sampling-ready mode. The button’s LED will light up.

To continue, press the SAMPLING START/STOP button, as described below.



**START/STOP button**

In Sampling, Program, Combination, and Sequencer modes, pressing this when the SAMPLING REC button is lit will do one of three things, depending on the setting of the **Trigger** parameter (on the Sampling mode Recording - Audio Input page):

- If **Trigger** is set to **Sampling START SW**, sampling will begin immediately.
- If **Trigger** is set to **Note On**, sampling will begin as soon as you play a note on the keyboard.
- If **Trigger** is set to **Threshold**, sampling will begin as soon as the selected audio source reaches a preset volume level.

On the Sampling mode’s P1: Sample Edit page, pressing this button will play the selected sample.

This button is also used to play back WAV files from the disk. You can play back WAV files in the directory window of various Disk mode pages, in the Disk mode Make Audio CD page, in the Sequencer mode audio track editing dialog boxes, and in the **Select Directory/File for Sample to Disk** menu command in Program, Combination, Sequencer, and Sampling modes.

**19. TouchView display**

The KRONOS features our exclusive TouchView graphic interface, based on a touch-panel LCD screen.

By touching objects displayed in the LCD screen, you can select pages, set parameter values, move sliders and knobs, enter text, connect virtual patch cables, and more.

**Shortcuts**

The front-panel controls offer a number of shortcuts for commonly-used features, as detailed below.

**ENTER + numeric keys 0–9: Menu commands**

Each page has a set of menu commands, which provide access to different utilities, commands, and options, depending on the page you’re currently on. You can use the menu commands entirely from the touch-screen, by pressing the menu button in the upper right-hand corner of the screen and then selecting an option from the menu that appears.

Even though each page may have its own unique menu commands, the menus are standardized as much as possible. For instance, WRITE is almost always the first menu item in Program, Combination, and Global modes.

You can take advantage of this standardization by using a shortcut to access any of the first ten menu items:

1. **Hold down the ENTER button.**
2. **Press a number (0-9) on the numeric keypad to select the desired menu command, starting with 0.**

For instance, press 0 for the first menu command, 1 for the second, and so on.

If the menu command just toggles an option on and off (such as Exclusive Solo), then you're done. If the command calls up a dialog box, the dialog will appear on the LCD, and you can proceed just as if you'd selected the command from the touch-screen.

### **ENTER + REC/WRITE: Auto Song Setup**

The Auto Song Setup feature copies the current Program or Combination into a Song, and then puts the KRONOS in record-ready mode.

If inspiration for a phrase or song strikes you while you're playing, you can use this function to start recording immediately. To do so:

1. **Hold down the ENTER key and press the SEQUENCER REC/WRITE key.**

The Setup to Record dialog box will open and ask "Are you sure?"

2. **Press OK.**

You will automatically enter Sequencer mode, and will be in the record-ready state.

3. **Press the START/STOP key to start the sequencer and begin recording.**

### **ENTER + keyboard: Enter note or velocity value**

Generally, if a parameter specifies a note number or velocity, you can enter the value by playing on the keyboard. To do so:

1. **Select one of the Key parameters.**
2. **Hold down the ENTER button.**
3. **While holding ENTER, play a note on the keyboard.**

You can use this shortcut throughout the KRONOS, such as for setting keyboard and velocity zones, or selecting the note to edit in Drum Kits, Multisamples, or RPPR setups.

### **ENTER + LOCATE: Set locate point**

This shortcut sets the Sequencer's locate point to the current measure, beat, and tick, similar to using the **Set Location** menu command (see "Set Location (for Locate Key)" on page 629 of the Parameter Guide).

1. **Hold down the ENTER button.**
2. **While holding ENTER, press the LOCATE key.**

After this, pressing LOCATE returns the Song to the newly set measure, beat, and tick.

### **ENTER + touch Program name: Edit Program**

You can jump directly into the editing pages of a Program from within a Combination or Song—while still hearing all of the other Timbres or Tracks. To do so:

1. **Go to the P0-1: Prog Select/Mixer page in Combination mode, or the P0-1: MIDI Track Prog Select/Mixer page in Sequencer mode.**
2. **Hold the ENTER button, and then touch the Program's name in the Timbre or Track.**

The system will then display the P0 page for the selected Program. The front-panel PROG button's LED will blink, and the COMBI or SEQ LED will remain solidly on, to show that you are editing the Program in context.

3. **Edit as desired.**

Eventually, if you want to keep your changes, you'll need to Write the Program. However, while you're working, you can go back and forth between the edited Program and the Combination or Song.

To return to the Combination or Song:

4. **Press the front-panel COMBI or SEQ buttons.**

For more information, including other ways to move between the modes, see "Editing Programs from within a Combination or Song" on page 72.

### **CONTROL ASSIGN RT KNOBS/KARMA switch (LED ON) + KARMA MODULE CONTROL switch**

In Combination and Sequencer modes, this sets the **Module Control** to **Master**. This is the same as setting **Module Control** to **M** in P0: Control Surface—RT/KARMA.

### **CONTROL ASSIGN TONE ADJ/EQ switch (LED ON) + SWITCH 1...16 switches**

In Combination and Sequencer modes, you can use a shortcut to change the current Timbre directly from the Control Surface, without leaving Tone Adjust mode:

1. **Press and hold the TONE ADJ/EQ button.**
2. **While holding TONE ADJ/EQ, press a MIX PLAY/MUTE or MIX SELECT button to select a Timbre.**

The PLAY/MUTE buttons select Timbres 1–8, and the SELECT buttons select Timbres 9–16.

This is the same as the selected Timbre/Track in TIMBRE/TRACK mode; changing one will also change the other.

3. **Release the TONE ADJ/EQ button.**

The Control Surface and screen will change to show the Tone Adjust parameters for the newly selected Timbre.

### **EXIT switch: Return to main page**

This button makes it easy to return to the main page of the current mode:

- Press it once to go to the previously-selected tab on the main P0 page.
- Press it again to go to the first tab on the main P0 page.
- Press it a third time to select the main parameter on the P0 page, such as the Program name in Program mode.

Wherever you are in Program, Combi, or Sequencer modes, pressing EXIT three times (or fewer) will take you back to Program/Combination/Song Select, where you can immediately use the numeric keys or  $\wedge/\vee$  switches to select a Program, Combination, or Song.

### **EXIT switch: Cancel in dialog boxes**

When a dialog box is displayed, this has the same function as the Cancel, Done, or Exit button.

## Rear panel

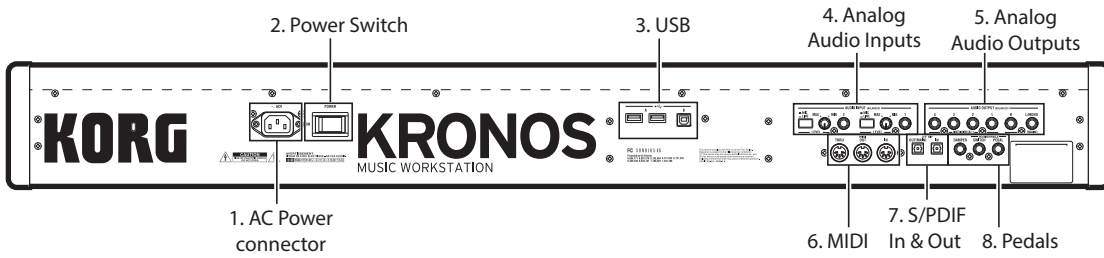

### 1. AC Power connector

Connect the included power cable here.

We recommend that you first connect the power cable to the KRONOS, and then connect the other end of the cable to an AC outlet (see “1. Connecting the power cable” on page 20).

### 2. POWER switch

This switch turns the power on and off. Before turning KRONOS off, make sure that you’ve saved any edits to your Programs, Combis, Songs, or other user data.

After turning the power off, please wait for at least ten seconds before you turn the power on again.

### 3. USB ports

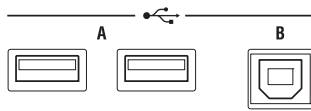

#### USB A ports

There are two external, high-speed USB 2.0 ports. You can use these to connect storage media such as hard disks, flash media, etc, as well as class-compliant USB MIDI controllers. For more information, see “5. Connecting USB devices” on page 23.

#### USB B port

This high-speed USB 2.0 port lets you connect to a Mac or Windows PC, for sending and receiving MIDI and audio, and for connecting to the computer editor program. For more information, see “7. Connecting to computers via USB” on page 24.

### 4. Analog AUDIO INPUTS

You can use the audio inputs for recording, sampling, and real-time mixing through the built-in effects.

#### Mic/Line Inputs 1 and 2

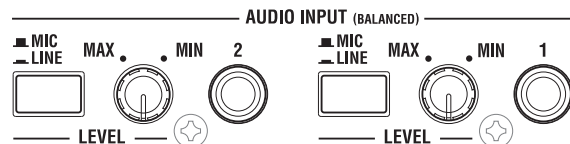

Inputs 1 and 2 provide 1/4” TRS balanced connectors. You can use these for either microphone-level or line-level signals. The two inputs have identical sets of controls, as described below.

#### MIC/LINE switches

These set the input’s nominal signal level. Set these switches according to the type of device that you’re connecting, and then use the LEVEL knobs (described below) to optimize the gain.

Use the LINE setting (button pressed in) when connecting to mixers, computer audio systems, signal processors, or other synthesizers. The nominal level is +4dBu, with 12dB of headroom.

Use the MIC setting (button popped out) only when connecting a microphone.

#### LEVEL knobs

These knobs let you make more precise adjustments to the input level, after setting the basic levels with the MIC/LINE switches.

The MIN setting is unity gain; the MAX setting provides about 40dB of gain above unity.

### 5. Analog AUDIO OUTPUTS

All of the analog audio outputs use balanced TRS 1/4” phone jacks, referenced to a +4dBu signal level.

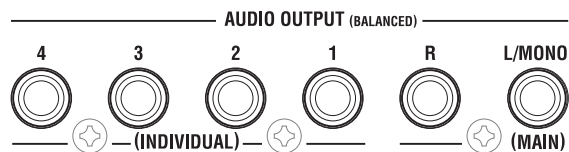

Connect these outputs to the input jacks of your amp or mixer. In addition to the L/MONO and R main stereo audio outputs, the KRONOS provides four individual audio outputs.

The sound from each oscillator, drum, timbre/track, or insert effect can be freely routed to any output. Additionally, you can route the metronome sound to an individual output, to separate it from the stereo mix. For more information, see “Effects selection and routing” on page 214.

#### (MAIN) L/MONO, R

These are the main stereo outputs; their volume is controlled by the MAIN VOLUME knob. All of the factory Programs and Combis are programmed to play through these outputs.



When editing sounds, or when setting up a Song in Sequencer mode, you can access the main outputs by setting **Bus Select** to **L/R**.

If no cable is connected to the R output, L/MONO will carry a mono summation of the stereo signal. So, if you are connecting to a device which does not have stereo inputs (such as a simple keyboard amp), use the L/MONO output.

**(INDIVIDUAL) 1...4**

These 4 additional audio outputs let you isolate sounds, audio inputs, or audio tracks for recording or complex live sound setups.

These can be used as stereo or mono outputs, in any combination. You can also use the Global Audio page **LR Bus Indiv. Assign** parameter to map the main stereo outputs to any of these output pairs, if you like.

Note that the individual outputs are not affected by the MAIN VOLUME knob.

**6. MIDI**

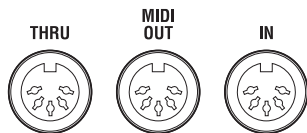

MIDI lets you connect KRONOS to computers or other MIDI devices, for sending and receiving notes, controller gestures, sound settings, and so on. For more information on MIDI connections, please see “MIDI applications” on page 1131 of the Parameter Guide.

**MIDI THRU connector**

MIDI data received at the MIDI IN connector is re-transmitted without change from the MIDI THRU connector.

You can use this to chain multiple MIDI devices together.

**MIDI OUT connector**

This connector transmits MIDI data. Use this to control external MIDI devices, or to record into an external sequencer.

**MIDI IN connector**

This connector receives MIDI data. Use this to play the KRONOS from another MIDI device, or from an external sequencer.

**7. S/P DIF IN & OUT**



These jacks provide 24-bit, 48kHz optical S/P DIF input and output, for connecting to computer audio systems, digital mixers, etc.

Optical S/P DIF is sometimes called TOSLINK, and formally named (hold your breath!) IEC60958, EIAJ CP-1201. Make sure to use optical cables designed for digital audio.

Whenever you use digital audio connections, make sure that all connected systems are set so that there is one and only one word clock master. You can set the word clock for the

KRONOS using the Global page **System Clock** parameter. For more information, see “System Clock” on page 756 of the Parameter Guide.

**OUT(MAIN) jack**

This optical S/P DIF output carries a digital version of the main L/R outputs.

Note that the MAIN VOLUME knob does not adjust the S/P DIF output level.

**IN jack**

You can use this optical S/P DIF input for recording, sampling, and real-time mixing through the built-in effects.

It can be used simultaneously with the analog and USB audio inputs, if you like.

**8. Pedals**

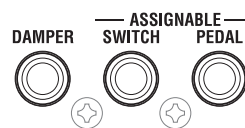

**DAMPER jack**

For the damper—also known as the sustain pedal— you can connect either a standard footswitch, or Korg’s special half-damper pedal, the optional DS-1H.

The DS-1H is a continuous pedal designed specifically for piano-style damper control, with the look and feel of an acoustic piano’s sustain pedal. It allows more subtle control of the damper than a simple switch; the further down you press the pedal, the more that the sound sustains. For more information, see “Half-Damper Pedal and Release Time” on page 40 of the Parameter Guide.

You can also connect a simple footswitch, which will work as a standard on/off damper pedal.

In order to ensure that the pedal functions correctly, please adjust the switch polarity (see “Damper Polarity” on page 781 of the Parameter Guide) and the half-damper sensitivity (see “Half Damper Calibration” on page 806 of the Parameter Guide).

**ASSIGNABLE SWITCH jack**

This lets you connect a simple on/off footswitch, such as the optional Korg PS-1. The footswitch can perform a wide variety of functions, such as modulating sounds and effects, tap tempo, sequencer start/stop, etc.

The switch’s function is set in Global mode (on the Controllers tab of the Controllers/Scales page), so that it always works the same regardless of the current Program, Combi, or Song. For more information, please see “Setting up the Assignable Switch and Pedal” on page 171.

**ASSIGNABLE PEDAL jack**

This lets you connect a continuous controller pedal, such as the Korg EXP-2 foot controller or Korg XVP-10 EXP/VOL pedal, to use as an assignable modulation source.

Like the ASSIGNABLE SWITCH, the pedal’s function is set in Global mode. For more information, please see “Setting up the Assignable Switch and Pedal” on page 171.

## TouchView user interface

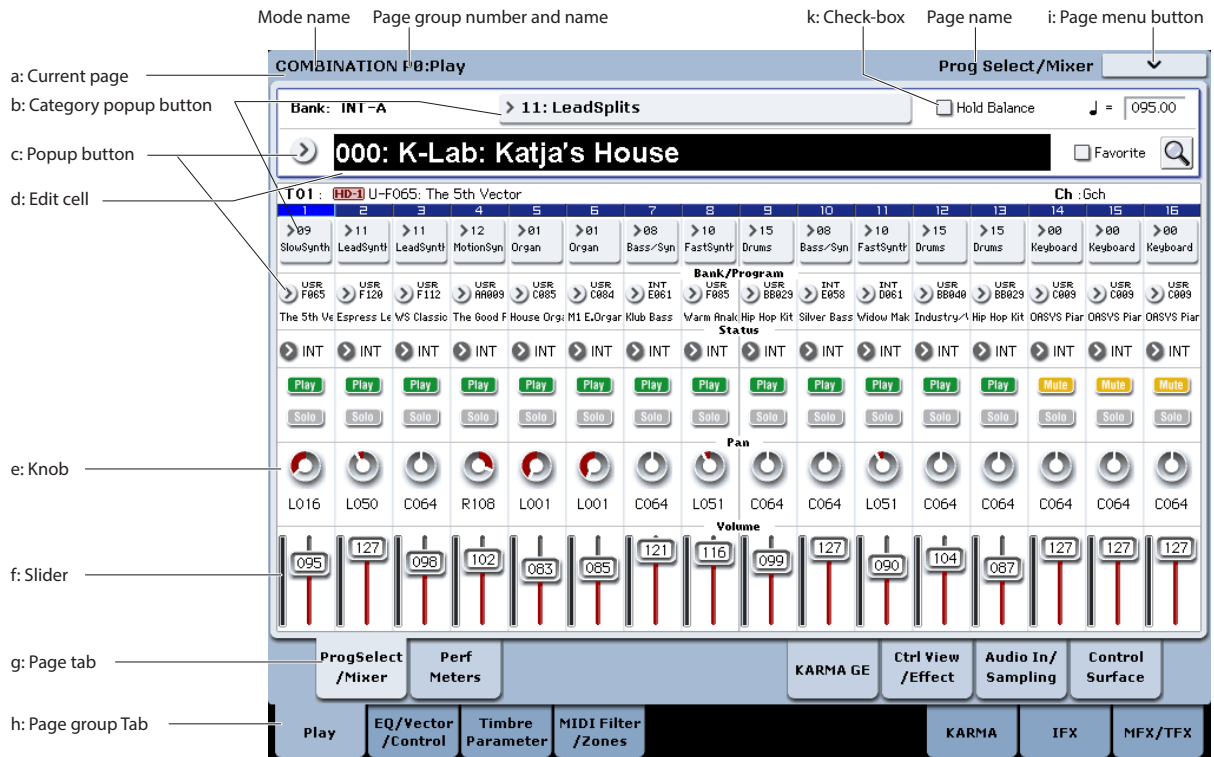

The KRONOS uses Korg’s TouchView graphical user interface. By touching objects displayed in the LCD screen, you can select pages, set parameter values, move sliders and knobs, enter text, connect virtual patch cables, and more.

### a: Current page



From the left, the top of the display shows the current mode, the number and name of the page group, and finally the name of the individual page.

### b: Category button

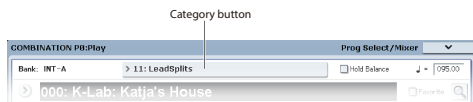

When you press this button, a tabbed popup menu will appear, allowing you to select Programs, Combinations, or GEs organized by category.

For more information, see “Tabbed popup menus,” below.

### c: Popup button & menu

When this button is pressed, a popup menu will appear, showing a list of options. In some cases, these will be parameter values. In others, they may be lists of items, such as Multisamples or FX Presets.

To enter a parameter value, touch the desired value.

### Pin

Many popup menus have a “Pin” in the upper left. This controls what happens after you select a value. Touch the pin graphic to switch between open (unlocked) and closed (locked).

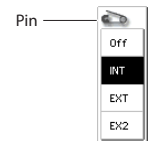

When locked (pin closed), the popup menu will remain displayed even after you select a parameter value. To close the popup, either unlock the pin, or press EXIT.

When unlocked (pin open), the popup menu will close immediately when you press a parameter value, or when you touch the screen outside the menu.

*Note:* In some cases, such as when a parameter is assigned to Tone Adjust, the pin may have no effect.

### Tabbed popup menus

Some popups have a large number of items divided into groups. The groups are represented by tabs on the left-hand side of the screen. These include:

- Bank/Program Select and Bank/Combination Select: Select Programs or Combinations by bank
- Multisample Select: Select a Multisample for a Program oscillator by category
- Wave Sequence Select and Drum Kit Select: Select a Wave Sequences or Drum Kit for a Program oscillators by bank
- Effect Select: Select an effect by category
- Select a user Sample for a user Multisample
- Select a KARMA GE

To close a tabbed popup menu, press the OK button or Cancel button.

### Scroll bar

When a list is too long for all items to fit on the screen at once, the popup includes scroll bars. You can touch in the empty areas of the scroll bar to move back and forth in the list, or touch and drag the scroll handle.

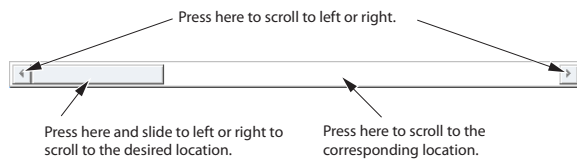

### d: Edit cell

When you touch a parameter in the LCD screen, the parameter or parameter value will usually be highlighted (displayed in inverse video). This is called the **edit cell**, and the highlighted item is now selected for editing.

The parameter value of the edit cell can be modified using the VALUE controllers. In some cases, you may also use a popup menu, as described below.

Alternatively, in most cases you can edit the value by touching the edit cell and dragging your finger up or down. (A few parameters don't support this editing method.) If your hand is obscuring the parameter value on the screen, you can drag your finger to the left or right before editing; as long as you don't lift your finger from the screen, the parameter will stay selected.

For parameters that accept a note number or a velocity value, you can also hold down the ENTER switch and play a note on the keyboard to enter the note number or velocity value.

### e & f: On-screen sliders, knobs, and meters

To edit an on-screen slider or knob, simply touch it and then drag to change its value. Knobs can generally be turned by both up-down and right-left gestures.

Alternatively, you can first touch the slider or knob and then use the VALUE controllers to modify the value.

On-screen meters show audio levels for Program Oscillators (on the Control Surface page), Combination Timbres, Song Tracks, insert, master, and total effects, and the main output.

### g & h: Page group tabs and Page tabs

Press the lower row of tabs to select the page group, and then press the upper row of tabs to select the page. The top of the screen shows the name of the current page and group, as described under "a: Current page" on page 10.

### i: Page menu button

When this button is pressed, a list of menu commands will appear. The available commands will vary depending on the current page. To select a command, just touch it.

The page menu will close when you press the LCD screen at a location other than the page menu, or when you press the EXIT switch.

Even though each page may have its own unique menu commands, the menus are standardized as much as possible. For instance, WRITE is almost always the first menu item in Program, Combination, Set List, and Global modes.

### Menu shortcut: ENTER + numeric keypad

You can use a shortcut to access any of the first ten menu items:

1. Hold down the ENTER key.
2. Press a number (0-9) on the numeric keypad to select the desired menu command, starting with 0.

For instance, press 0 for the first menu command, 1 for the second, and so on.

If the menu command just toggles an option on and off (such as Exclusive Solo), then you're done. If the command calls up a dialog box, the dialog will appear on the LCD, and you can proceed just as if you'd selected the command from the touch-screen.

### Dialog box

Many menu commands use dialog boxes to make additional settings. The dialog box that appears will depend on the currently selected menu command.

To confirm settings in a dialog box, press the OK button. To exit without making changes, press the Cancel button. After pressing either OK or Cancel, the dialog box will close.

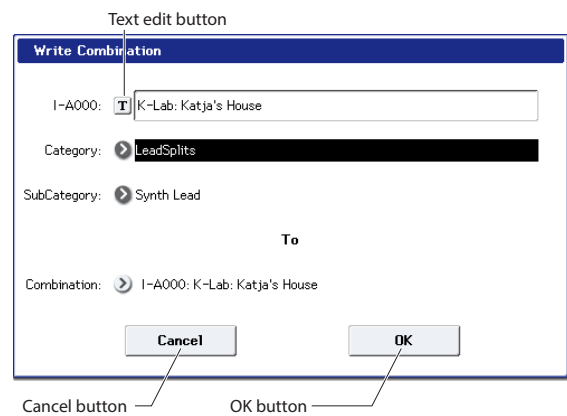

### Text edit button

Pressing this button brings up an on-screen keyboard, for changing the name of Programs, Combis, Songs, Wave Sequences, Drum Kits, etc. For more information, see "Editing names and entering text" on page 193.

## Other objects

### j: Radio button

Press a radio button to select one value from two or more choices.



### k: Check box

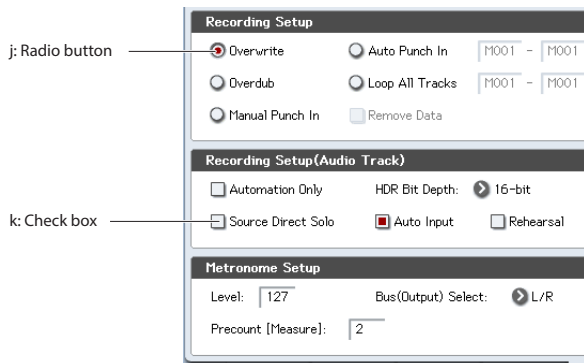

Each time you press a check box, it alternates between the checked (red) and unchecked states.

The parameter will be active if it is checked, and inactive if it is unchecked.



Play/Rec/Mute buttons in Sequencer mode:  

Solo On/Off buttons in Sequencer mode:  

Effects On/Off buttons:  

## Patch panel

The MS-20EX and MOD-7 use on-screen patch panels to route audio and control signals.

To make a connection between two patch points:

- **Touch one of the two jacks (either input or output), and drag your finger across the screen to the second jack.**

A yellow line appears as you drag across the screen, and is replaced by a patch cable once the connection is made.

To delete a connection between two patch points:

- **Touch the input jack, and drag off of the jack.**

The selected connection will be deleted.

## Program Play page Overview/Jump graphics

The main P0 Play page in Program Mode features an interactive overview of the most important parameters, such as oscillators, filters, envelopes, LFOs, and so on. Just touch any of these overview areas, and you'll jump to the corresponding edit page.

## CX-3 Drawbars

You can edit CX-3 drawbars just as you would other slider controls, by touching and dragging the individual drawbars one by one.

There's also a special feature that allows you to drag shapes across all of the drawbars at once. To use this feature, enable the **Drag Across Drawbars** check-box in the lower right of the P: 5-2: Drawbars page. Then, drag a shape across all of the drawbars horizontally.

## Toggle buttons

This type of button will change its function or switch on/off each time it is pressed.

## Basic information

### About the KRONOS' modes

The KRONOS has a large number of features that let you play and edit programs and combinations, record and play sequence data, record and play back samples, and manage data on disk. The largest unit used to organize these features is called a mode.

The KRONOS has seven modes.

---

#### Set List mode

Set Lists make it simple to play and organize any of the sounds loaded into the KRONOS, without regard for what bank they're stored in or whether they're Programs, Combinations, or even Songs.

Large on-screen buttons make sound selection fast and foolproof, and the Program Up or Down footswitch assignments can be used for hands-free sound changes. Cut, copy, paste, and insert tools make re-ordering a snap.

Smooth Sound Transitions (SST) let the previous sound and its effects ring out naturally, making it easy to change sounds during a live performance. SST is active in all of the KRONOS modes, but Set Lists give you greater control over the transitions. You can fine-tune the ring-out time for each sound, so that (for instance) one sound fades out very quickly, while another sound's delays continue to repeat for ten or twenty seconds.

Set Lists are great for live performance, but they're also handy for organizing sounds in general. For example, you could create a Set List with all of your favorite String sounds, including both Programs and Combinations.

---

#### Program mode

Programs are the basic sounds of KRONOS. In Program mode, you can:

- Select and play Programs
- Edit Programs
 

Make detailed settings for oscillators, filters, amps, EGs, LFOs, effects, KARMA, vector synthesis, etc. The specific parameters will vary depending on the synthesis type: HD-1, AL-1, CX-3, STR-1, MS-20EX, PolysixEX, MOD-7, EP-1, or SGX-2.
- Create drum programs using drum kits (as created in Global mode)
- Play and control one KARMA module
- Sample and resample
 

For example, you can sample an external audio source while listening to a performance generated by KARMA, or you can play a Program and resample your performance.

---

#### Combination mode

Combinations are sets of up to 16 Programs that can be played simultaneously, letting you create sounds more complex than a single Program. In Combination mode, you can:

- Select and play Combinations
- Use KRONOS as a 16-track multitimbral tone generator
- Edit Combinations
 

Assign Programs to each of the 16 Timbres, each with separate volume, pan, EQ, and keyboard and velocity zones; make settings for effects, vector synthesis, Drum Track, and KARMA.
- Control and play up to four KARMA modules
- Sample or resample
 

For example you can sample an external audio source while listening to the performance of the KARMA, or resample a performance you play using a combination.

---

#### Sequencer mode

Sequencer mode lets you record, play back, and edit MIDI tracks and audio tracks. You can:

- Select and play Songs
- Edit Songs
 

Assign Programs to each of the 16 MIDI Tracks, with separate volume, pan, EQ, and keyboard and velocity zones; make settings for effects, vector synthesis, Drum Track, and KARMA
- Record up to sixteen MIDI tracks simultaneously
- Record up to four of the sixteen audio tracks simultaneously, mix using automation, and import WAVE files.
- Control and play up to four KARMA modules
- Sample or resample
 

You can sample an external audio input source while playing a song, and use In-Track Sampling to automatically create a note event that triggers the sample at the same time as it was recorded.

You can also resample an entire song, and then use Disk mode to create an audio CD.
- Use KRONOS as a 16-track multitimbral tone generator
- Record patterns and assign them to individual keys, using RPPR (Realtime Pattern Play/Recording)
- Create your own Drum Track Patterns

---

### Sampling mode

Sampling mode lets you record and edit your own Samples and Multisamples. For example, you can:

- Record samples from external audio sources, including sampling through effects
- Edit the recorded samples, or samples loaded from disk; set loop points, truncate, time-slice, etc.
- Create and edit Multisamples, which consist of one or more Samples spread out across the keyboard
- Quickly convert Multisamples into Programs
- With a USB CD-R drive (not included), sample directly from audio CDs
- Create massive sounds using the generous internal RAM: if you like, a single Multisample can use about 6 hours of sampling time
- Load a number of these huge Multisamples at once, via User Sample Banks and Virtual Memory

---

### Global mode

Global mode lets you make overall settings for the entire KRONOS, and edit wave sequences and drum kits. For instance, you can:

- Make settings that affect the entire KRONOS, such as master tune and global MIDI channel
- Set up sample auto-loading at startup
- Manage currently loaded samples
- Create user scales
- Create user Drum Kits and Wave Sequences using samples from ROM, EXs, User Sample Banks or Sampling Mode
- Rename Program, Combination, and KARMA GE categories
- Set the function of the assignable pedals and assignable switches
- Transmit MIDI System Exclusive data dumps

---

### Disk mode

Disk mode lets you save, load, and manage data using the internal disk and external USB 2.0 storage devices. You can:

- Save and load Programs, Combinations, Songs, Samples, and Global setup data
- Format disks and storage media, copy and rename files, etc.
- Load AKAI, SoundFont 2.0, AIFF, and WAVE samples, and export RAM samples in AIFF or WAVE formats
- Export and import sequences to and from SMF (Standard MIDI Files)
- Use the Data Filer function to save or load MIDI System Exclusive data
- With a USB CD-R drive (not included), create and play back audio CDs

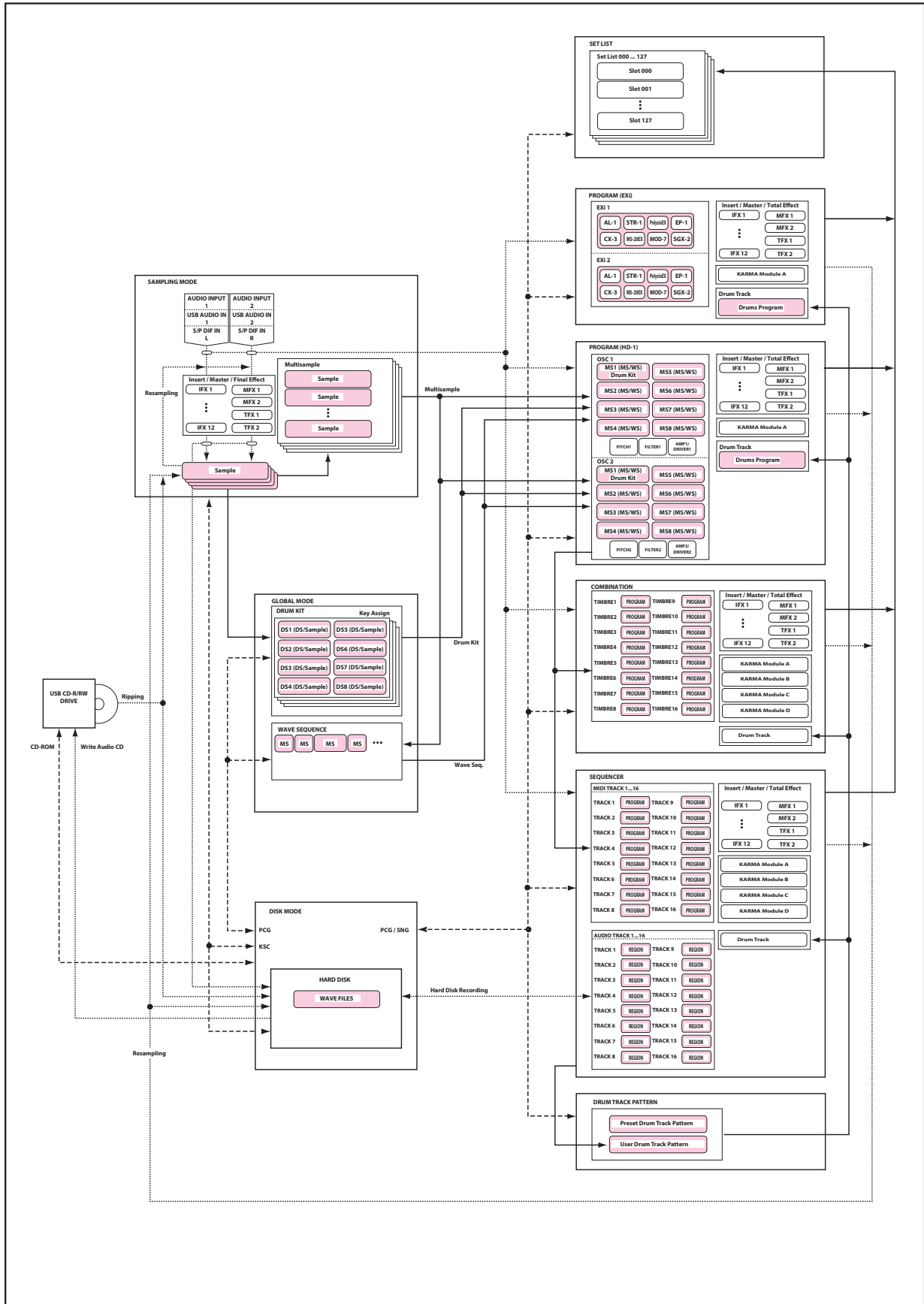

## About the KRONOS' PCM memory

“PCM” is another way of saying “samples.” The KRONOS has several types of PCM banks, as described below: ROM, EXs, User Sample Banks, and Sampling Mode data

For more information on the contents of the included ROM and EXs sample data, see the Voice Name List (VNL).

### ROM

The KRONOS ROM contains the basic multisamples and samples, and is always loaded and available.

### EXs

EXs stands for EXpansion Samples. These can be loaded or not, as you wish. The KRONOS comes with a number of EXs libraries, including multiple gigabytes of samples.

### User Sample Banks

User Sample Banks may be sounds that you create yourself, or load from imported Akai or SoundFont 2.0 libraries, or WAV or AIFF files.

### Sampling Mode data

Sampling Mode is used to create and edit samples. When you save Sampling Mode data, it becomes available as a User Sample Bank.

### Using samples in your own sounds

You can use any of these bank types, together or separately, when making your own sounds. Simply set the Bank as desired in the Program or Wave Sequence Step's

**Multisample Select** fields, or the Drum Kit **Drumsample Select** fields. For more information, see:

- Program: “Bank (Multisample),” on page 57 of the Parameter Guide
- Wave Sequence: “Bank (Multisample),” on page 793 of the Parameter Guide
- Drum Kit: “Bank,” on page 798 of the Parameter Guide

### Lossless compression

When EXs data is loaded into RAM, the KRONOS uses a lossless compression technique. This yields a modest reduction in size; for instance, EXs1 uses 284MB of RAM for 313MB of data.

You'll notice that this is much milder than the dramatic size reductions of mp3, or the PCM compression sometimes found in other synthesizers. There is a strong advantage over these other methods, however: the KRONOS compression is completely lossless, and causes absolutely no degradation in audio quality.

### Loading samples at startup

The KRONOS can load your favorite samples automatically at startup. For more information, see “Automatically loading sample data” on page 174.

### User sampling RAM capacity

The KRONOS is equipped with 3 GB of RAM. Approximately 1 GB of this RAM is used by the operating system and ROM sample data. The remainder is shared between the samples in EXs, User Sample Banks, and Sampling Mode.

This means that the size of the currently loaded EXs and User Sample Banks trades off against the memory available for Sampling Mode. The more space used by EXs and User Sample Banks, the less is available for Sampling Mode.

Using Virtual Memory for EXs and User Sample Banks generally lets you load more samples at once, but may still use a substantial amount of RAM.

*Note:* To check the amount of sample RAM available, see “0–1f: Free Sample Memory/Locations” on page 686 of the Parameter Guide.

For more information, see “Free RAM and approximate sampling times” on page 131.

---

## About polyphony

Most hardware synthesizers offer a single, fixed method of synthesis, a predetermined number of voices, and a fixed amount of effects processing power for a specific number of effects. KRONOS is different; it has no fixed synthesis method, its polyphony varies depending on which synth engines are being used, some synth engines provide additional effects (augmenting the 16 normal effects slots), and there are sometimes trade-offs of processing power between voices and effects.

This flexibility means that the system can deliver power where you need it the most. As you play different sounds from different synth engines, the KRONOS automatically divides its processing power appropriately.

Unlike most computer-based systems, KRONOS also monitors the overall processing power, reducing the overall number of voices if necessary, to make sure that there are never problems with the audio.

Normally, you shouldn't need to think about this at all; it will just happen automatically. Sometimes, however, it can be convenient to know how the system is allocating its resources. The Performance Meters page shows this information; you can find it on the Perf Meters tab of P0 in Program, Combination, and Sequencer modes. For more information, see “0–2: Performance Meters” on page 7 of the Parameter Guide.



## Basic operations

After you've turned on the KRONOS, here's how to perform basic operations such as selecting modes and pages.

### 1. Selecting modes

In order to use a particular function on the KRONOS, you must first select the appropriate mode.

Press one of the front panel mode buttons to enter the corresponding mode. These include **SET LIST**, **COMBI** (Combination mode), **PROG** (Program mode), **SEQ** (Sequencer mode), **SAMPLING**, **GLOBAL**, and **DISK**.

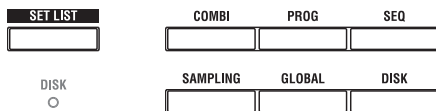

### 2. Selecting pages

Each mode has a large number of parameters, which are grouped into pages. These are further subdivided by tabs into up to nine tab pages.

#### 1. Select the desired mode, as described above.

We'll use Program mode as an example for our explanation, so press the PROG switch.

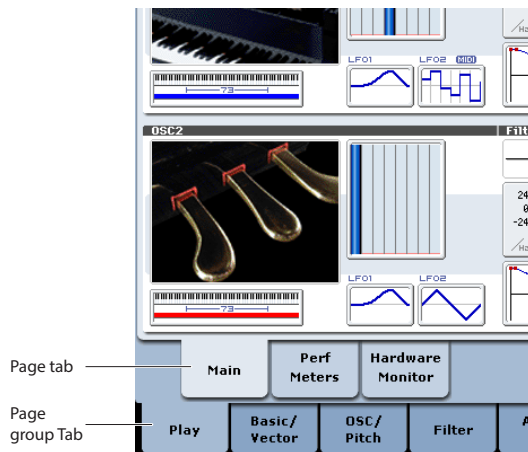

#### 2. Press a tab in the lower line (page group tabs).

As an example here, press the Basic/Vector tab. The current page indication in the upper left of the LCD screen will indicate "PROGRAM P1: Basic/Vector," and the page group will change.

When you press the EXIT switch, you will return to P0 from any page.



Basic Vector tab

#### 3. Press a tab in the upper line (page tabs) to select a page.

As an example here, press the Vector Control tab. The current page indication in the upper left of the LCD screen will stay the same, but the upper right indication will change to "Vector Control." You've selected the Vector Control page.

*Note:* In some cases, there may not be any tabs in the upper line.

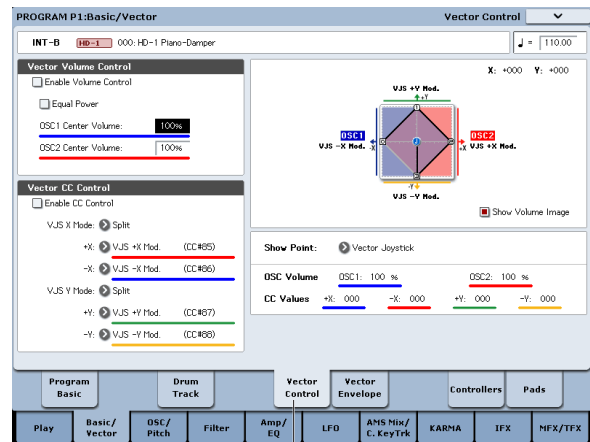

Vector Control tab

### 3. Editing parameters

The parameter value in the edit cell can be set by using the front panel VALUE controllers, including the VALUE slider,  $\wedge/\vee$  switches, VALUE dial, numeric keys 0-9, and the -, ENTER, and (.) switches.

Alternatively, in most cases you can edit the value by touching the edit cell and dragging your finger up or down. (A few parameters don't support this editing method.)

The COMPARE button lets you switch back and forth between edited and saved versions of sounds.

For some parameters, you can use the BANK SELECT switches to select the bank of a program etc., or press a popup button to access a popup menu where you can specify the value of the parameter. In some cases, you can hold down the ENTER switch and play a note on the keyboard to specify a note or a velocity value.

## VALUE entry

### VALUE slider

Use this when you wish to make major changes in the value.

In Program mode and Combination mode, this slider can also be used as a control source for alternate modulation or dynamic modulation. (This is active in Program or Combination P0: Play when the “Program Select” or “Combination Select” (the large characters in the upper part of the LCD) is selected).



VALUE

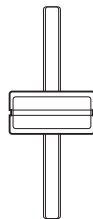

### ^/∨ buttons

Use these when you wish to make small changes in the value.

### VALUE dial

Use this when you wish to make large changes in a value.

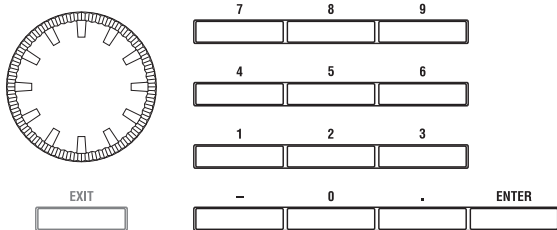

### Numeric keys 0–9, ENTER, –, (.)

Use these when you know the parameter value that you wish to input.

After using the numeric keys 0–9 to input a number, press the ENTER switch to finalize the parameter value.

Use the – switch to enter negative numbers.

Use the (.) switch to enter a decimal point.

### BANK I–A...G, U–A...G buttons

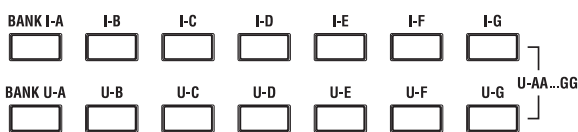

The BANK I–A...G, U–A...G buttons are used in Program mode to select the program bank and in Combination mode to select the combination bank. In combination, and Sequencer modes, these switches are used to select the bank of the program used by each timbre/track.

### COMPARE switch



Use this when you wish to compare the edits you have made to a program or combination’s sound with the un-edited original (i.e., the sound that is written into memory).

When editing a program or combination, press this switch. The LED will light, and the last-written settings for that program number or combination number will be recalled.

When you press the COMPARE switch once again, the LED will go dark and you will return to the settings that you were editing.

If you edit the settings that are recalled by pressing the COMPARE switch (i.e., the settings that are written into memory), the LED will go dark, and it will not be possible to return to the previous edits by pressing the COMPARE switch again.

In Sequencer mode, you can use the COMPARE switch to make “before and after” comparisons immediately after using realtime recording or step recording to record a song, or after performing a track edit operation.

For example, this can be used effectively when realtime-recording a track for a song.

1. **Realtime-record a MIDI track. (Take 1)**
2. **Once again, realtime-record on the same track. (Take 2)**
3. **Press the COMPARE switch. The LED will light, and take 1 will be recalled.**
4. **Press the COMPARE switch once again. The LED will go dark, and take 2 will be recalled.**
5. **If at step 3 you once again realtime-record on the same track (take 3), the object of the Compare function will now be take 1.**

If at step 4 you once again realtime-record on the same track (take 3), the object of the Compare function will be take 2.

In this way, the Compare function lets you recall the previous recording or the previous state of event editing.

The Compare function does not work in Global mode, with the exception of Sampling, Disk, Wave Sequence, and Drum Kit editing.

### Popup buttons and popup menus

You can press a popup button to access a popup menu, and then set parameter values.

### Keyboard input

When entering a note number or a specific velocity as the value of a parameter, you can use the keyboard to input the setting. Hold down the ENTER switch and play the note that you wish to enter as a value. The note number or velocity value will be input.

When the Global P5: Drum Kit page is displayed, you can hold down the ENTER switch and play a note to recall the settings that have been assigned to that note. (If the parameter you’ve selected expects you to enter a velocity value, the velocity you played will be entered.)

In Sampling mode, you can hold down the ENTER switch and play a note to recall the index that is assigned to that note.

---

## 4. Selecting and executing menu commands

The menu provides commands that are specific to each page, such as Write (save) or Copy. The available functions will depend on the current page.

For example, the utility functions in Program mode let you write (save) the settings, perform convenient editing operations such as copying settings between oscillators or effects, “Sync” EGs so that you can edit two of them at once, and so on.

### 1. In the upper right of the display, press the menu button.

A list of menu commands will appear.

### 2. Select a menu command by pressing it with your finger.

A dialog box for the selected menu command will appear. Check-type commands will not display a dialog box; their status will be switches, and the list will close. By holding down the ENTER switch and pressing a numeric key 0–9 you can access the dialog box for the first ten utility functions without going through the menu.

- To close the list without selecting a command, press the display somewhere other than the list, or press the EXIT switch.

### 3. For a parameter in a dialog box, select it by pressing it with your finger, and use the VALUE controllers (e.g., VALUE dial or Inc/Dec buttons) to enter its value.

When selecting a program or combination number in a dialog box, you can also use the BANK SELECT switch to enter the bank as an alternative to using the VALUE controllers.

### 4. To execute the command, press the OK button. If you decide not to execute the command, press the Cancel button or the EXIT button.

The dialog box will close.

Preset/user Drum Track patterns are saved in internal memory even when the power is turned off. Patterns you create in Sequencer mode can be converted into user Drum Track patterns and saved in internal memory.

- User template songs: see “Saving your own Template Songs” on page 84

Preset/user template songs are saved in internal memory even when the power is turned off. Track settings and effect settings of a song you create can be saved in internal memory by the menu command Save Template Song.

For more information, see “Writing to internal memory” on page 192 and “Saving to disks, CDs, and USB media” on page 196.

---

## 5. Writing and saving

After you edit, you should write or save your changes as necessary. For example if you’ve edited a program, your changed will be lost if you select another program or turn off the power. The same applies to a combination. Settings you edit in Global mode will be remembered as long as the power is on, but your changes will be lost when you turn off the power.

For details on the Write operations, see the following pages.

- Programs: see “Saving your edits” on page 46
- Combinations: see “Saving your edits” on page 74
- Effect presets: see “Saving Effect Presets” on page 223
- Global settings: see “Writing Global settings” on page 195
- Wave Sequences: see “Saving Wave Sequences” on page 185
- Drum kits: see “Saving Drum Kits” on page 189
- User Drum Track patterns: see “Converting a Sequencer pattern to a Drum Track pattern” on page 257

## Setup

### Turning the power on/off

#### 1. Connecting the power cable

1. Set the KRONOS's rear-panel POWER switch to the off position.
2. Connect the included power cable to the KRONOS' rear panel AC power inlet.
3. Connect the other end of the power cable to the AC power outlet.

 If your power cable uses a separate ground wire, you must connect this ground wire before inserting the plug into the AC outlet. When disconnecting, you must first disconnect the plug before you disconnect the ground wire. If you are unsure of how to make connections, please contact your Korg Distributor.

 Make sure that your AC outlet is the correct voltage for your instrument.

#### 2. Turning the power on

1. Press the rear panel POWER switch to turn on the power.
2. Turn on your powered monitors or stereo amp.
3. Turn the KRONOS's MAIN VOLUME knob clockwise to an appropriate level, and adjust the volume of your powered monitors or stereo amp.

 After you've turned off the power, you must wait approximately ten seconds before turning the power on again.

*Tip:* You can set the **Power On Mode** (Global P0: Basic Setup page) so that the mode and page that had been selected when you turned the power off will appear when the power is turned on.

For more information, see "Recalling the last-selected mode and page at power-on" on page 169.

#### 3. Turning the power off

 When you turn off the power, the programs and combinations etc. will revert to their unedited state. If you want to keep your edits, you'll need to Write them. For more information, see "Saving data" on page 191.

 Similarly, Songs and user multisamples and samples will disappear when you turn off the power. If you want to use these songs, user multisamples, and samples the next time you turn on the power, you'll need to load them again.

1. Set the front panel MAIN VOLUME knob and the volume of your powered monitor or stereo amp to zero.
2. Turn off the power of your powered monitor or stereo amp.
3. Press the KRONOS's POWER switch to turn off the power.

 Never turn off the power while data is being written into internal memory. The display will show the message "Now writing into internal memory" when this is in progress.

 Never turn off the power while media such as the internal drive is being accessed, **such as while recording or playing audio tracks, or sampling to disk for an extended time.** Turning off the power while disk access is occurring may render the media unusable. The DISK LED shows when the internal drive is being accessed.

#### Auto Power-Off

The KRONOS can be set to automatically turn off the power when the system has not been active for a certain length of time. "Activity" includes using the TouchView display and most front panel controls, playing sounds, sending or receiving MIDI, local or ftp disk activity, etc. It *does not* include usage of the MASTER VOLUME or AUDIO INPUT knobs or the MIC/LINE buttons, however.

 When the power turns off, any un-saved edits or settings will be lost. Make sure that you save important settings before this occurs.

You can control the amount of time before the system turns off, or disable Auto Power-Off entirely. To do so:

1. Go to the **Global P0: Basic Setup** page.
2. In the menu, select the **Auto Power Off Setting...** command.

The dialog box below will appear.

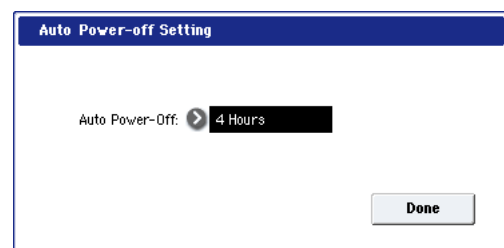

3. Press the "Auto Power-off" popup button to select the length of idle time after which the power will turn off. If you don't want the power to turn off automatically, set this to Disabled.

4 hours is the default.

You can also reach this dialog box from the two warning dialogs associated with Auto Power-Off, as described below.

#### Changing the Auto Power-off setting at startup

If Auto Power-off is enabled, a dialog box indicating the time until automatic power-off will appear immediately after start-up.

The dialog box will close automatically after a few seconds. The hourglass icon shows how much time is left before it closes. If you touch this icon, the hourglass will pause (shown by a red "X") and the dialog box will remain open. To close the dialog box, press the Change Setting or OK buttons, or simply wait for the hourglass to complete.

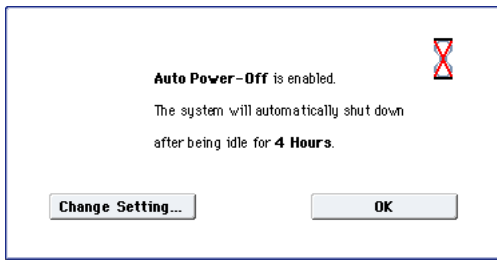

**1. To change the auto power-off setting, press the Change Setting button.**

The **Auto Power-Off Setting** dialog box will appear, just as if you'd selected the Global menu command described above.

**Auto power-off warning message**

When the specified length of time has elapsed without any user input on the KRONOS, a message will appear, warning you that the auto power-off function is about to turn off the power.

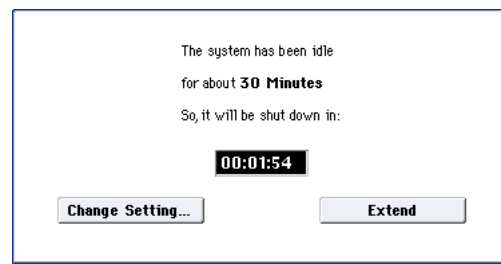

If you want to continue using the system, press the keyboard, a button, or some part of the display such as the Extend button. The Auto power-off function will be reset. If the specified length of time again elapses with no user input, the same message will appear again. You can also use the Change Setting button to bring up the **Auto Power-Off Setting** dialog, as described above.

**Earlier models may not support Auto Power-Off**

On KRONOS models which do not support Auto Power-Off, the menu command and related dialogs will not appear.

## Connections

-  Connections must be made with the power turned off. Please be aware that careless operation may damage your speaker system or cause malfunctions.

### 1. Analog audio output connections

Here's how to connect the KRONOS to your analog amp or mixer.

-  If you're using a home stereo system, be aware that playing at high volume may damage your speakers. Be careful not to raise the volume excessively.

**AUDIO OUTPUT (MAIN) L/MONO and R**

These are the main outputs, accessed by setting **Bus Select** to L/R. All of the factory sounds use these outputs, and the Master and Total Effects are always routed here as well.

All of the KRONOS analog outputs use 1/4" balanced TRS jacks. For best results, use balanced connections to your audio system.

**1. Connect the AUDIO OUTPUT (MAIN) L/MONO and R outputs to the inputs of your amp or mixer.**

If you're using KRONOS in stereo, use both the (MAIN) L/MONO and R jacks. If you're using KRONOS in mono, use only the (MAIN) L/MONO jack.

**2. Use the MAIN VOLUME knob to adjust the volume.**

The MAIN VOLUME knob affects only the main stereo outputs and the headphones; it does not affect the individual outputs, the S/P DIF output, or the USB output.

**AUDIO OUTPUT (INDIVIDUAL) 1...4**

These are 4 additional analog outputs, which can be used as individual mono outputs, stereo pairs, or any combination of the two. Almost any signal source can be routed to these outputs, including:

- Each note in a Drum Kit
- Insert Effect outputs
- Individual Programs in a Combination or Song (or the sum of the Program's oscillators in Program mode)

- Audio tracks
- Audio inputs

You can use these to isolate or group together sounds for recording, or for complex live performance setups.

- 1. Connect the (INDIVIDUAL) 1...4 outputs to the your amp or mixer inputs.**
- 2. Use the Bus Select parameters to send the desired sounds, audio tracks, inputs, or effects to the individual outputs, as either mono (1...4) or stereo (1/2 and 3/4) signals.**

If the signal is going through one or more insert effects, the output is set at the last IFX in the chain, via the **Bus Select** parameter on the P8-5 Insert FX page.

If a Program, Timbre, or Track is *not* going through any insert effects, the output is set using the **Bus Select** parameters on the P8-1 or 8-2 Routing page.

To assign audio inputs directly to outputs, use **Bus Select** parameters in the P0- Audio Input (Sampling) page.

In Global mode, the Audio page **L/R Bus Indiv. Assign** setting lets you mirror the MAIN stereo L/R output on any pair of individual outputs. You can use this to create a private monitoring setup in live and studio environments. For more information, see "L/R Bus Indiv. Assign" on page 761 of the Parameter Guide.

*Note:* The MAIN VOLUME knob doesn't affect the volume of the individual outputs.

**Headphones**

- 1. If you're using headphones, connect them to the KRONOS' headphone jack.**
- 2. Use the VOLUME slide to adjust the volume of the headphones. The KRONOS' headphone jack outputs the same signal as the (MAIN) L/MONO and R jacks.**

*Tip:* To monitor the signals from the individual outputs, use an external mixer.

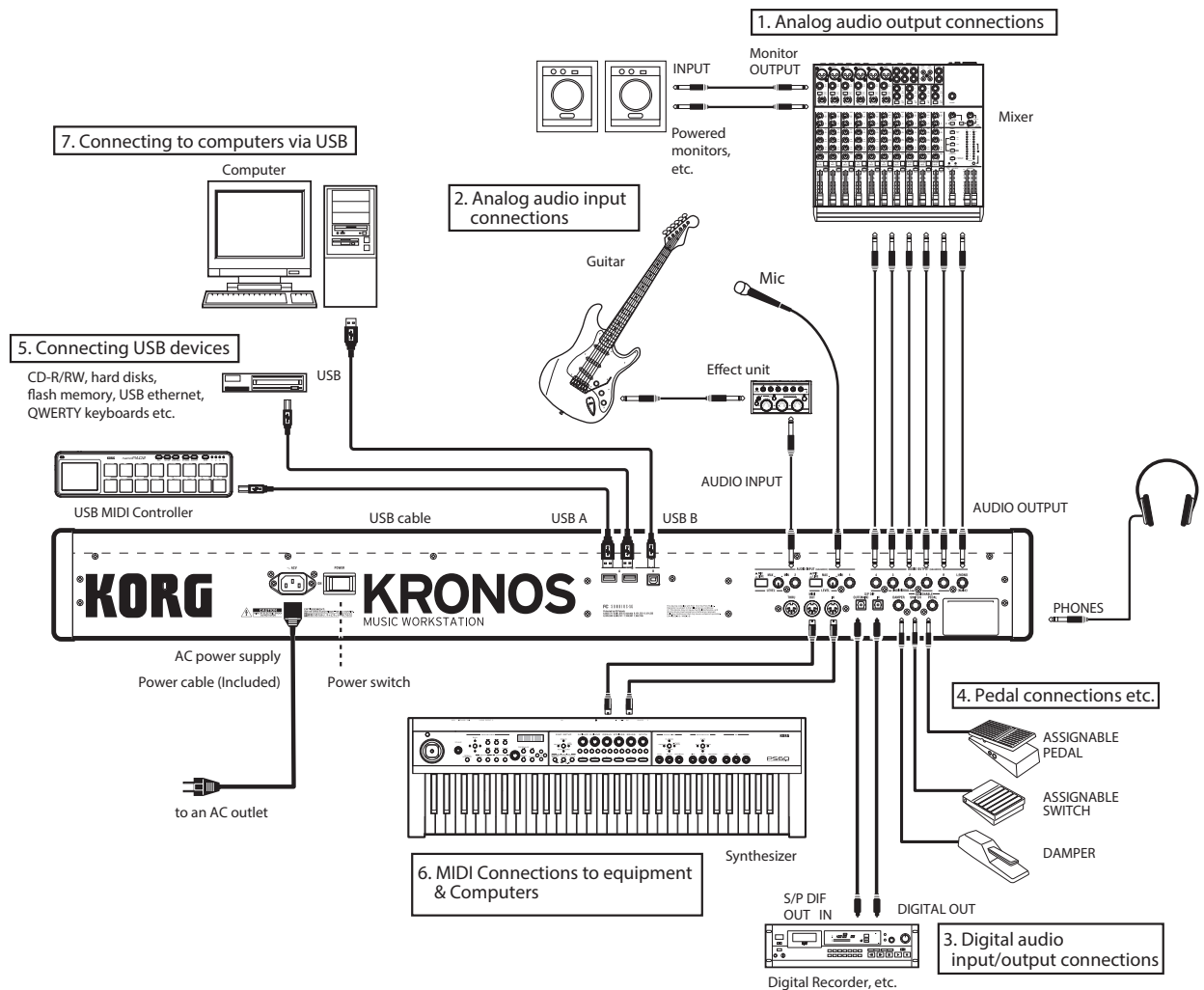

## 2. Analog audio input connections

You can bring external analog audio sources into the KRONOS for sampling, recording, or processing through the internal effects.

### AUDIO INPUT 1, 2

These two inputs use 1/4" TRS balanced jacks, and include preamps with adjustable gain. To set up the audio inputs:

1. Connect your mics or the output jacks of your external audio sources to the INPUT 1 and 2 jacks.
2. Set the MIC/LINE switch as appropriate for the device you've connected, and use the LEVEL knob to adjust the gain.

Choose the LINE setting (switch pressed inward) if you've connected a mixer, computer, audio system, signal processor, or another synthesizer. For best results, use balanced line connections.

*Note:* Guitars with active pickups can be connected directly. Guitars with passive pickups (i.e., guitars that do not have an internal preamp) can be used, but the impedance mismatch will cause both a change in tone and a reduction in volume. For best results, route such guitars through a pre-amp or effects unit before connecting them.

Choose the MIC setting (switch in the outward position) only when connecting a mic. Note that some microphones, such as condensers, may require external phantom power, which is not supplied by the KRONOS.

3. Adjust the output level on any connected external equipment.
4. After turning on the power, use the Audio Input page to set up the volume, pan, bus routing, and send levels for the inputs, as desired.

For more information, see "0-8: Audio Input/Sampling" on page 14 of the Parameter Guide.

## 3. Digital audio input/output connections

### Digital audio output

The KRONOS main stereo output can be digitally transmitted to an audio system, digital mixer, or other device that can accept a sampling rate of 48 kHz.

- Use an optical cable to connect the S/P DIF OUT (MAIN) jack to the optical digital input jack of your device.

This will carry the same audio signal as the AUDIO OUTPUT (MAIN) L/MONO and R jacks.

*Note:* The MAIN VOLUME knob doesn't affect the volume of the digital output.



## Digital audio input

You can record or sample the digital output of a S/P DIF device running at 48 kHz, such as a computer audio system or digital mixer. You can also route the input directly to the KRONOS outputs, or through the internal effects.

1. Use an optical cable to connect the optical digital output of your digital audio device to the S/P DIF IN jack of the KRONOS.
2. Set System Clock (on the Global P0: Basic Setup page) to S/P DIF.
3. After turning on the power, use the Audio Input page to set up the volume, pan, bus routing, and send levels for the inputs, as desired.

For more information, see “0–8: Audio Input/Sampling” on page 14 of the Parameter Guide.

You can use the S/P DIF inputs simultaneously with the analog and USB inputs.

## 4. Connecting Foot Pedals and Switches

### Connecting a damper pedal

The damper pedal is also sometimes called the sustain pedal. It acts like the similarly-named pedal on an acoustic piano; when you hold down the pedal, notes will continue to sustain even when you lift your hands off of the keyboard.

1. Connect an optional DS-1H damper pedal to the DAMPER jack. If you’ve connected a DS-1H, you’ll be able to obtain half-damper effects.

After turning the power on:

2. Go to the Global P2: Controllers/Scales page, and use the Damper Polarity parameter to set the damper polarity.
3. Go to the Global P0 page, and use the Half Damper Calibration menu command to adjust the sensitivity if desired.

For more information, see “Damper Pedal (Sustain)” on page 38, and “Damper Polarity” on page 781 of the Parameter Guide.

### Connecting a foot switch

You can use a connected foot switch to perform functions such as controlling sostenuto, soft pedal on/off, KARMA on/off, selecting Programs, Combinations, or Set List Slots, starting/stopping the sequencer, and controlling tap tempo.

1. Connect a foot switch such as the optional PS-1 to the ASSIGNABLE SWITCH jack.
2. After turning the power on, use Global P2: “Foot Switch Assign” and “Foot Switch Polarity” to assign the function controlled by the foot switch and to specify the polarity.

For more information, see “2–1a: Foot Switch & Pedal/Damper” on page 781 of the Parameter Guide.

### Connecting a foot pedal

You can use a connected foot pedal to control volume, modulation, or other functions.

1. Connect an optional XVP-10 or EXP-2 etc. to the ASSIGNABLE PEDAL jacks.

2. After turning the power on, use Global P2: “Foot Pedal Assign” to assign the function controlled by the foot pedal.

For more information, see “Foot Pedal Assign” on page 781 of the Parameter Guide.

## 5. Connecting USB devices

The KRONOS supports high-speed USB 2.0 for connecting to storage devices, such as hard drives, flash media, and CD-R/RW drives, as well as class-compliant USB MIDI controllers.

### USB storage devices

You can save and load samples, sounds, sequences, and other data to and from USB 2.0 storage devices for backup, transferring to computers, etc.

Note that HDR tracks must be played from and recorded onto the internal disk. You can back them up to USB devices, however.

The maximum supported capacity depends upon the format of the USB device. With FAT16 format, the maximum capacity is 4 GB; with FAT32, the maximum is 2 Terabytes (2,000 GB).

1. Use a USB cable to connect your USB storage device to one of the KRONOS’s USB A ports.

Standard USB cables have a different connector at each end. Plug the flat, rectangular connector into the KRONOS, and plug the square-ish connector into the external USB storage device.

**Note:** If the device you are using does not support hot-plugging, make connections with the device powered-off, and then turn on the power of your device.

2. Wait a few seconds for the device to be recognized.
3. Use the Disk mode Drive Select screen to check the connection.

For more information, see “Loading & saving data, and creating CDs” on page 191.

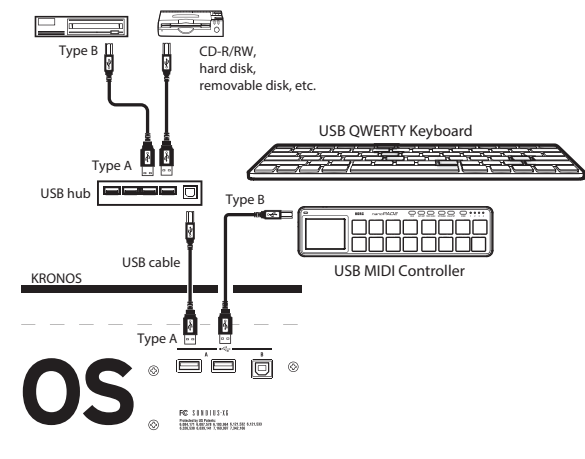

### USB MIDI controllers

You can connect class-compliant USB MIDI controllers directly to the KRONOS, and use them just as you would controllers connected to the 5-pin MIDI jacks. To do so:

1. Use a USB cable to connect your USB MIDI controller to one of the KRONOS’s USB A ports.

If the controller is set to a different MIDI channel than the KRONOS's Global MIDI Channel, you can use it to play a different sound than the local keyboard in Combinations or Songs, as controlled by the Timbre or Track MIDI settings.

You can also play the chord pads using Korg USB MIDI controllers equipped with drum pads, including:

- nanoPAD and nanoPAD2
- microKONTROL
- padKONTROL
- KONTROL49

When these controllers are connected, the KRONOS will automatically determine the MIDI assignments of the controller's pads 1-8, and map them directly to the KRONOS pads.

For more information, see "USB MIDI controllers" on page 1132 of the Parameter Guide.

### USB alphanumeric keyboards

Anywhere that you can enter text, you can use a connected USB alphanumeric keyboard as an alternative to the touch-screen keyboard. The standard US "IBM PC" QWERTY keyboard layout is recommended.

### Hot-plugging

The KRONOS supports USB hot-plugging. This means that you can connect or disconnect the USB cable while the power is on.

**Note:** In order to use hot-plugging, the USB device you are connecting must also support hot-plugging.

### 8 USB devices maximum

KRONOS has two separate USB 2.0 ports, and can support up to 8 USB devices simultaneously. Note that it doesn't matter how the devices are connected; even if you use hubs or different ports, the maximum is always 8 devices.

### USB Power

Some USB devices get their power from the USB connection. These are called "bus-powered" devices, and they are supported by the KRONOS.

Other USB devices may require a separate power source, in addition to the USB connection; in this case, you'll need to use an appropriate power adaptor for the device.

There is a limitation to the total current supplied to all connected USB devices, as defined by the USB specification. If the total current consumption of the connected devices exceeds this limit, the KRONOS may not correctly recognize the connected USB devices. If this happens, the error message "USB Hub Power Exceeded!" will appear.

To avoid this problem, if you connect more than one USB device, please use a self-powered USB hub in self-powered mode. For details on connections and settings for your hub, please refer to its documentation.

For details on the electrical current used by a specific USB device, refer to its owner's manual.

---

## 6. MIDI connections to equipment & computers

### Connections to MIDI equipment

The keyboard, controllers, and sequencer etc. of the KRONOS can be used to control an external MIDI tone generator. Conversely, another MIDI keyboard or sequencer can control the tone generator of KRONOS to produce sound.

- Use MIDI cables to connect the MIDI connectors of KRONOS with the MIDI connectors of your external device.

For more information, see "Connecting MIDI devices & computers" on page 1131 of the Parameter Guide.

### Connections to a computer via MIDI

In conjunction with MIDI software on your computer, you can use the KRONOS as a MIDI controller, and transmit the KRONOS sequencer playback as MIDI data. You can also play the KRONOS sounds from the computer. To do so:

- Use a MIDI interface to connect the MIDI connectors of KRONOS to the MIDI connectors of your computer.

For more information, see "Connecting MIDI devices & computers" on page 1131 of the Parameter Guide.

*Note:* Some USB-MIDI interfaces may not be able to transmit or receive the KRONOS's MIDI System Exclusive messages.

---

## 7. Connecting to computers via USB

The KRONOS's USB B port lets you connect to a USB-equipped Mac or Windows PC, for sending and receiving MIDI and audio, and for connecting to the KRONOS Editor.

To do so:

- 1. Install the Korg USB MIDI driver from the included Accessory Disc 3, or as downloaded from the Korg website.**

On Accessory Disc 3, the installers are located in the following directories. Double-click the driver installer to start the installation.

*Windows:* Windows folder/DrvTools folder/DrvTools\_e.exe

*Mac OSX:* Mac folder/KORG USB-MIDI Driver folder/KORG MIDI-Driver.pkg

- 2. Follow the on-screen instructions to complete the installation.**

For both Windows and Mac OSX the KRONOS uses the standard, built-in USB audio drivers, so no additional installation is necessary for audio.

- 3. Turn on the KRONOS.**

- 4. Connect the KRONOS's USB B port to one of your computer's USB ports.**

When the KRONOS is connected, the computer will recognize it as a USB MIDI Device and USB Audio Device.

For more information, including details on setting up and using the KRONOS Editor/ Plug-In Editor, please see the "KRONOS Editor/Plug-In Editor Manual" (PDF).



### **About the software**

The most recent versions of the Korg drivers and Editor/Plug-In Editor can be downloaded from the Korg website (<http://www.korg.com/kronos>).

### **Please note before use**

Copyright to all software included in this product is the property of Korg Inc.

The license agreement for this software is provided separately. You must read this license agreement before you install this software. Your installation of this software will be taken to indicate your acceptance of this agreement.

### **Windows System Requirements**

Computer: USB port required (a USB host controller made by Intel is recommended)

Operating system: All editions of Microsoft Windows Vista, Microsoft Windows 7, and Microsoft Windows 8

### **Macintosh System Requirements**

Computer: USB port required

Operating system: Mac OSX 10.6.4 or later

## Update information

---

### New features in software version 3.0

The KRONOS (2014) comes with KRONOS software version 3.0 pre-installed; all previous models of KRONOS may be upgraded to this version.

KRONOS software version 3.0 is a major upgrade, featuring the new SGX-2, system-wide touch-drag gestural input from the touch-screen, larger on-screen fonts, the ability to edit Programs in the context of Combinations and Songs, 12 vintage effects, and a raft of improvements to Set Lists.

There's also a new Find feature for locating Programs and Combinations by name, audio level meters for Oscillators, Timbres, Tracks, and effects, improved support for non-equal-tempered scales, and support for editing text via USB alphanumeric keyboards. Last but not least, if a sound requires samples which aren't currently loaded, you can now load those samples in a single step.

In addition to these new features, the update includes various improvements and resolutions to specific operational issues.

If you're using an older version, you can download the latest software free of charge from the Korg website (<http://www.korg.com/kronos>).

---

#### SGX-2

The updates to the SGX-1 are so significant that we thought it deserved an updated name as well—hence, the SGX-2.

First, the SGX-2 now includes modeled String Resonance, for an even more realistic playing experience (older sounds will need to be edited manually to enable this feature).

Under-the-hood changes also enable powerful new Piano Types with up to 12 velocity zones and dedicated Una Corda samples—such as those of the EXs17 Berlin D Piano. For more information, see “SGX-2 Premium Piano” on page 58.

---

#### Touch-drag gestural input

Throughout the KRONOS, you can now simply touch your finger to a parameter and drag on the display to change its value. This applies to all knobs, sliders, drawbars, and numeric parameters. You can also touch and drag to create and delete connections on the MS-20EX and MOD-7 patch panels.

---

#### Editing Programs from within a Combination or Song

You can now jump directly into the editing pages of a Program from within a Combination or Song—while still hearing all of the other Timbres or Tracks. Tweak a step sequencer pattern, for instance, or experiment with patch cables in the MS-20EX. For more information, see “Editing Programs from within a Combination or Song” on page 72.

---

#### Vintage effects

The new Vintage effect category includes 12 effects based on the CX-3 and EP-1. Classics such as the Small Phase and Vox Wah, are now available as insert, master, and total effects.

---

#### Set List improvements

Set Lists now support different colors for each Slot, to make them easier to distinguish quickly. Slots can now also be transposed individually.

You can make more room for comments by showing only 4 or 8 Slots at a time, or show 16 Slots so that you have the maximum number of sounds under your fingertips. A new Comment Panel, accessible by touching the comment area and swiping downwards, temporarily dedicates the entire screen to the comment. You can also choose different font sizes for each Slot's comments, from small (to fit more text without scrolling) to ultra-large (for easy visibility).

---

#### Find

The new Find feature, accessed by a magnifying-glass-shaped button in most selection dialogs, lets you search for Programs, Combinations, and other data by name. For more information, see “Using the Find feature” on page 33.

---

#### Meters

On-screen meters now show audio levels for Program Oscillators (on the Control Surface page), Combination Timbres, Song Tracks, insert effects, and the main output.

---

#### Improved scale support

A new Global parameter, **Osc/Timbre/Track Transpose**, determines how the Program Oscillator, Combination Timbre, and Song Track Transpose parameters interact with the Scale and Key. For more information, see “Interaction between Transpose and Scale” on page 169.

---

#### Load Required Samples

If a Program, Combination, or Song uses EXs, User Sample Bank, or Sampling Mode data which is not currently loaded, the **Samples Not Loaded** message appears at the top of the display. You can now use the **Load required samples** command to load all of the required samples in a single step. For more information, see “Load required samples” on page 149 of the Parameter Guide.

---

#### USB alphanumeric keyboard support

Anywhere that you can enter text, you can now use a connected USB alphanumeric keyboard as an alternative to the touch-screen keyboard. A keyboard with the standard US “IBM PC” QWERTY layout is recommended. For more information, see “Editing names and entering text” on page 193.

---

#### Other improvements

Program banks I-A...F may now be configured as either HD-1 or EXi.

---

## New features in software version 2.1

KRONOS software version 2.1 adds several new features, including a newly improved CX-3 and three new features tailored for live performance: a polyphony-saving option for Timbre/Track Mute, realtime indication of Rotary Speaker speed in all performance modes, and the ability to assign external MIDI CCs (from a pedal controller, for instance) to a number of special functions.

In addition to these new features, the update includes various improvements and resolutions to specific operational issues.

---

### Improved CX-3

We've added a brand-new effects section to the CX-3, with many updates and improvements to the Amp, Rotary Speaker, and Vibrato Chorus, including:

- New amp model with warmer, smoother overdrive and more natural control from the expression pedal
- Three new speaker types, including one based on new measurements of a classic rotary speaker, another inspired by a popular rotary speaker pedal effect, and a third for bright sounds to cut through the mix, each with an option to include some of the direct signal for greater high- and low-frequency extension
- Improved stereo sensation, including revised mic distance control
- Many other improvements to the rotary speaker's timbre and authenticity
- Improved Vibrato/Chorus, more true to the original hardware

A new parameter on the CX-3 Basic page, **Amp/VC/Rotary Mode**, lets you switch between the old (**Classic CX-3**) and new (**Custom**) versions of the effects independently for each CX-3 instance, as desired. For more details, see “4-1c: Amp/VC/Rotary mode” on page 229 of the Parameter Guide.

To prevent unwanted changes to your data, existing sounds are not automatically updated to use the new effects. For information on converting sounds, see “Changing a Program from Classic CX-3 to Custom” on page 229 of the Parameter Guide. We've also provided a revised version of the factory preload Programs, which you can load separately if desired (see “New CX-3 Programs,” below).

With either **Classic CX-3** or **Custom**, you also can now use JSX (pitchbend) like the speaker speed switch on a vintage organ: move it to the left for Chorale (slow) and to the right for Tremolo (fast).

### Rotary Speaker speed indicators

If you're using a Rotary Speaker, either as an effect or in the CX-3, a new graphic at the top of the display shows the current state of the Rotary Speaker (Fast, Slow, or Stop). Note that this is the current state—in other words, what you actually hear—which is a combination of the **Speed SW**, **Mode SW**, **Rotary On**, and **Amp Type** parameter settings and all associated AMS modulation. The CX-3's Play page graphics now show this as well. For more information, see “Rotary Speaker speed indicator” on page 226 of the Parameter Guide.

### New CX-3 Programs

We've updated the factory preload Programs to take advantage of the new CX-3. To prevent unexpected changes to your data, these new Programs are not loaded automatically. Instead, please download the separate file **PRELOAD\_V2.PCG** and copy it to your KRONOS. You can then load the new sounds just as you would any other PCG file. The original **PRELOAD.PCG** file remains on your disk as well, so you can re-load it at any time if desired.

Before loading the new sounds, make sure to back up your data to a PCG file on disk; the Save All command is a quick and easy way to do so (see “Saving memory contents to disk” on page 197).

---

### Mute Mode

Version 2.1 gives you a choice as to how the Mute buttons work in Combinations and Songs.

Previously, in Combis the Mute buttons muted the Timbre's audio output, which is convenient for sound design; in Songs, they stopped only the sequencer's output to the Track, while leaving the keyboard active.

These behaviors are still available when the new **Mute Mode** parameter is set to **Studio**. A second setting, **Live**, provides alternative behaviors designed for use in live performance.

In **Live** mode, Combination Mute buttons stop the MIDI input to the Timbre; this saves polyphony, and is well-suited to muting and un-muting layered sounds as you play. Similarly, Song Mute buttons control MIDI input from both the sequencer and the keyboard.

For more information, see “Mute Mode” on page 757 of the Parameter Guide.

---

### Function Assign for External MIDI In

You can now map incoming MIDI controllers to any of the special functions previously available only to the rear-panel foot switch input and SW1/2. This is particularly useful in conjunction with third-party MIDI and USB MIDI foot controllers with multiple built-in switches, each of which can now be mapped to a different function on the KRONOS. For instance, you can have multiple switches assigned to Program Up, Program Down, Octave Up, Octave Down, Tap Tempo, Chord On/Off, Ribbon Lock, etc.—all at the same time.

For more information, see “2-3: Function Assign” on page 784 of the Parameter Guide.

---

## New features in software version 2.0

KRONOS software version 2.0 adds a number of new features, including User Sample Banks, support for installing a second internal SSD, improved Akai and SoundFont 2.0 import, and support for USB ethernet adapters for transferring files between the KRONOS and your computer.

In addition to these new features, the update includes various improvements and resolutions to specific operational issues.

---

### User Sample Banks

User Sample Banks bring the benefits of EXs to your own custom sample libraries. You can load and play gigabytes of your custom or converted samples at once, using Virtual Memory. Disk and memory management is improved: you can create subsets of User Sample Banks, and mix and match parts of different banks, without duplicating samples on disk.

It's also easy to share sounds with friends and collaborators, since Programs maintain links to User Sample Banks even when samples are moved on disk or loaded onto different systems.

For more information, see "User Sample Banks" on page 162.

---

### Improved Akai and SoundFont 2.0 import

Version 2.0 features significantly improved Akai and SoundFont 2.0 import functionality. Most notably, up to 16 stereo velocity zones are now supported within a single HD-1 Program, by using stereo Multisamples and both OSC1 and OSC2.

---

## New features in software version 1.5

KRONOS software version 1.5 adds a number of new features, including the ability to load more sounds and samples at once, support for installing additional RAM, and support for Korg USB pad controllers such as the nanoPAD2.

Version 1.5 also supports the KRONOS Editor and Plug-in Editor software, providing editor/librarian capabilities for Mac OSX and Windows and compatibility with popular DAW software.

In addition to these new features, the update includes various improvements and resolutions to specific operational issues.

---

### 7 additional User Banks

KRONOS version 1.5 adds 7 more User Banks each of Programs, Wave Sequences and Drum Kits, numbered USER-AA through USER-GG. These banks are initialized by default, free for storing either your own sounds or libraries from Korg and third party sound developers.

---

### Second Internal SSD support

The KRONOS now supports installation of a second internal SSD, for more storage of samples, audio tracks, and program data. Installation must be done by an authorized service center; user installation is not supported and may void your warranty. Contact your Korg Distributor for details on purchase and installation.

---

### USB Ethernet and FTP support

The KRONOS now supports USB Ethernet adaptors and includes a built-in FTP server for fast, easy file transfer with personal computers. You can back up files to your computer, transfer samples to the KRONOS, and organize and re-name files and directories on the KRONOS internal disks.

The KRONOS supports a specific set of off-the-shelf USB Ethernet adaptors. Supported devices as of May 2012 are listed below.

- Apple USB Ethernet Adapter (MC704ZM/A)
- Cisco Linksys USB-300M
- TRENDnet TU2-ET100
- BUFFALO LUA3-U2-AGT
- BUFFALO LUA3-U2-ATX
- BUFFALO LUA-U2-KTX
- IODATA ETX3-US2
- Logitech LAN-TX/U2B
- Logitech LAN-TX/U2H3
- Planex UE-100TX-G3

Adaptors other than those listed above will not function properly.

For more information, see "Connecting to computers via USB Ethernet and FTP" on page 177.

Program Banks are easily accessed from the front-panel hardware by pressing both the INT and USER buttons simultaneously. For instance, to select USER-DD, press both INT-D and USER-D.

---

### Support for additional RAM

Installation of an additional 1GB of RAM is now supported, and can be performed at any authorized Korg service center. This approximately doubles the maximum available sample RAM, up to about 2 GB. Of course, when loading EXs using Virtual Memory, the total size of the loaded sample data can be much greater.

The KRONOS uses widely available, off-the-shelf DIMMs. Installation by an authorized Korg service center is required; user installation is not supported and may void your warranty. For more information on how to purchase and arrange for installation of RAM, please contact your country's Korg Distributor:

<http://www.korg.com/corporate/distributors/>

For compatibility with the KRONOS, RAM must comply with the following specification:

240-Pin PC2-6400 CL-5 (or CL-6) DDR2-800 non-ECC  
Unbuffered DIMM 1GB

---

## **4x increase to Sampling Mode Multisamples, Samples and Multisample Indexes**

The maximum number of Multisamples in Sampling Mode has been increased from 1,000 to 4,000, and the maximum numbers of Samples and Multisample Indexes have each been increased from 4,000 to 16,000. These 4x increases will be especially helpful when loading libraries with large numbers of relatively short samples, such as drums.

Note that EXs and User Sample Bank data does not count towards these maximums; they apply to the Sampling Mode data only.

---

## **Support for USB MIDI and Korg USB pad controllers**

Version 1.5 adds support for connecting USB MIDI class-compliant controllers directly to the KRONOS. For instance, you can use a Korg microKEY as an auxiliary synth-action keyboard for a KRONOS 73 or 88.

Even better, Korg USB MIDI controllers with pads—including the nanoPAD, nanoPAD2, padKONTROL, microKONTROL, and KONTROL49—are automatically mapped to the KRONOS chord pads, for playing and programming drums, triggering chords, and selecting and assigning chords for Chord Mode.

For more details, see “USB MIDI controllers” on page 1132 of the Parameter Guide.

---

## **KRONOS Editor and Plug-In Editor**

Version 1.5 adds support for the KRONOS Editor and Plug-In Editor, which let you edit and organize sounds from your Mac OS X or Windows computer. Plug-in operation allows you to save settings as part of your project with any VST-compatible Windows software, or any VST- or AU-compatible software on Mac OS X. The KRONOS Editor and Plug-In Editor will be available for free download at [www.korg.com/kronos](http://www.korg.com/kronos).



# Playing and editing Programs

## Playing Programs

### What's a Program?

Programs are the basic sounds of the KRONOS. You can play them by themselves, layer them together in Combinations, or play a different Program on each of the 16 MIDI tracks, either from the internal sequencer or from external computer-based sequencers.

This section of the manual takes a quick look at playing Programs, including tours of the front-panel controllers and basic editing techniques.

## Selecting Programs

There are several different ways to select Programs. Each one is convenient in a different way:

- Using the front-panel buttons, value slider, and value knob, you can select Programs quickly via physical controls
- Selecting by Bank and number (via the touch-screen) lets you browse through all of the Programs in memory, to find the one that you want
- Selecting by Program category (via the touch-screen) lets you filter Programs by sound type, such as Pianos or Drums
- Using Find (via the on-screen magnifying-glass icon) lets you search for Programs by name
- Using a foot-switch lets you change Programs even while both hands are busy playing on the keyboard – convenient for live applications
- MIDI program change messages let you select Programs remotely, from either a MIDI sequencer or an external MIDI controller

### Set Lists

Programs can also be selected in Set Lists, along with Combinations and Songs. For more information, see “Set Lists” on page 119.

## Overview: Program Banks

KRONOS ships from the factory with over 2,000 Programs loaded into memory. All of the factory Programs can be over-written with your own edits, if desired—except for the GM banks.

Hundreds of other Program slots are left open for your own programming or additional sound libraries. The exact contents may differ depending on the KRONOS model.

Programs are organized into 21 Banks, as described below. You can also store many more Programs on the internal disk(s), or on external USB 2.0 devices. Additional banks of sounds may already be on the internal disk as shipped from the factory.

USER-G is the default location for Programs created by resampling.

### Program Bank Contents

As shipped from the factory, the contents of the Program Banks are as follows:

*Program bank contents*

Bank	Contents	Bank Type
INT-A	Featured EXi sounds	Bank type can be set to either HD-1 or EXi
INT-B	Featured HD-1 sounds	
INT-C	SGX-2, EP-1, and “best of” other EXi	
INT-D	AL-1	
INT-E	AL-1 and CX-3	
INT-F	STR-1	
GM (I-G)	GM2 main Programs	GM
g(1)...g(9)	GM2 variation Programs	
g(d)	GM2 drum Programs	
USER-A	MS-20EX & PolysixEX	Bank type can be set to either HD-1 or EXi
USER-B	MOD-7	
USER-C...F	HD-1	
USER-G	Initialized HD-1 Programs	
USER-AA...BB	HD-1	
USER-CC...EE	Initialized EXi Programs *	
USER-FF...GG	Initialized HD-1 Programs *	

\* Bank contents may differ depending on the KRONOS model.

### Changing the Program Bank Types

Banks can contain either HD-1 Programs or EXi Programs, but not both. This assignment can be set separately for each bank. To do so:

1. **Press the front-panel GLOBAL button to enter Global mode.**
2. **Select the Basic tab.**
3. **Press the page menu button, and select Set Program Bank Type.**
4. **Change the Type for the desired banks. Leave all of the other banks set to “No Change.”**

**Important:** Setting a bank's type will erase all of the Program data in the bank - so make sure that you're not erasing any Programs you want to keep!

### 5. Press the OK button.

An “are you sure?” dialog appears.

### 6. If you’re certain of the change, press OK again.

The selected banks will now be initialized to use the new Program types.

## Selecting with the front-panel buttons

You can select Programs using the front-panel buttons, without touching the screen. To do so:

### 1. Make sure that the front-panel PROG button is lit.

This means that you’re in Program mode, in which you can select and edit Programs. If the button isn’t lit, press it now; it will light up, and the main Program Play page will appear.

### 2. Go to the main Program Play page.

The main Play page shows an overview of the sound structure, such as oscillators, filters, etc.

### 3. Make sure that the Program name is selected.

If it is not selected, go to the PROGRAM P0: Play page and touch the Program’s name, so that it’s highlighted.

### 4. Use the VALUE controllers to select the program number that you wish to play.

You can use the following methods to select a program.

- Turn the **Value** dial.
- Press the Inc  $\wedge$  or Dec  $\vee$  buttons.
- Use the numeric keypad [0]–[9] to specify the number, and press the **ENTER** key.

### 5. To select banks INT–A...G or USER–A...G, press and release the corresponding BANK button.

For example, to select bank INT–B, press the I–B button in the top row of Bank buttons. The I–B button will light, and the name INT–B will appear in the upper left of the LCD screen.

When you select a Bank, the button’s LED will light, and the selected bank will appear on the upper left side of the LCD screen.

### 6. To select banks USER–AA...GG, press and hold a pair of I and U BANK buttons together.

For example, to select bank USER–CC, press and hold the I–C button, and then press the U–C button. If you prefer, you can also press them in the opposite order: first U–C, and then I–C.

## Selecting by bank and number

You can select Programs from a list organized by Program bank.

### 1. Press the Program Select popup button.

The Bank/Program Select dialog appears.

*Bank/Program Select menu*

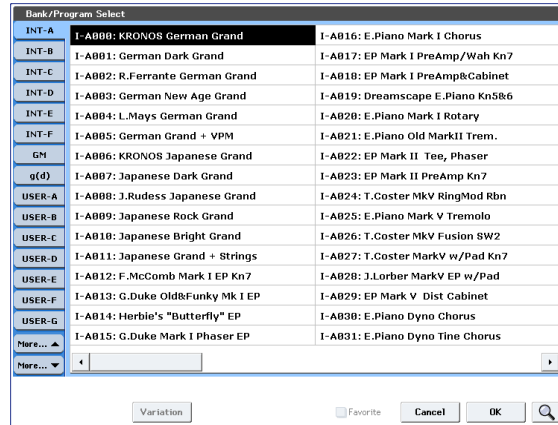

In this illustration, bank INT–A is selected. The list on the right shows the Programs contained in that bank.

### 2. Press the tabs on the left side of the display to select a bank.

There are more banks than can be shown at one time, so the banks are divided into two groups of tabs: INT–A...USER–G and USER–AA...USER–GG.

### 3. If necessary, use the “More...” buttons below the tabs to switch between showing the tabs for INT–A...USER–G and USER–AA...USER–GG.

### 4. Press one of the Program names in the list to select a Program.

The selected Program will be highlighted, and the keyboard will immediately switch to the new sound.

### 5. If you like, play a few notes to hear the new Program.

You can play the new Program while the menu is still showing, without needing to press OK.

### 6. When you are satisfied with the selected Program, press the OK button to close the popup menu.

If you press the Cancel button, the selection you made here will be discarded, and you will return to the program that had been selected before you opened the menu.



## Selecting by Category

You can select Programs from within a category, such as keyboard, organ, bass, and drums. When shipped from the factory, the Programs are organized into 16 categories, each with several sub-categories. There are also 2 more categories, initially named User 16 and User 17, which you can use and rename as desired.

### 1. Press the Category popup button.

The Category/Program Select dialog appears.

*Category/Program Select menu*



In the illustration above, the Motion Synth category is selected. The list on the right shows the Programs which belong to that category.

### 2. Press the tabs located to the left side of the display to select a different category.

The name of the selected category will be displayed in full in the lower left of the display.

### 3. Optionally, focus on a more specific group of sounds by selecting a sub-category from the second column of tabs.

The full name of the sub-category also appears in the lower left of the display.

### 4. Press one of the names in the center area to select a Program.

The selected Program will be highlighted.

### 5. When you are satisfied with the selected program, press the OK button to close the popup menu.

If you press the Cancel button, your selection will be discarded, and you will return to the Program that had been selected when you opened the popup menu.

## Using the Find feature

Near the top right corner of the Program P0:Play page, you'll see a button marked with a magnifying glass. Pressing this button brings up the Find dialog. You can use Find to search for Programs by name. To do so:

1. Press the magnifying glass to open the Find dialog.
2. Enter the text to search for.

For instance, you can enter "Pian" to search for Programs with "piano" in the name. **Ignore Case** is enabled by default; disable this if you want the find function to distinguish between upper and lower case.

In addition to the on-screen keyboard, you can use a USB alphanumeric keyboard to enter text. For more information, see "Editing names and entering text" on page 193.

### 3. Press Find to find matches to the entered text.

The names of Programs which match the provided text will appear, displayed one at a time.

### 4. Use the Next and Previous buttons to step through the Programs. Alternatively, use the front-panel Inc and Dec buttons.

You can audition the Programs by playing on the keyboard.

### 5. To select a found Program, press the OK button. To exit without selecting a new Program, press the Cancel button.

## Find is available throughout the system

Find is also available on the Combination Play page, and at the bottom right of the selection dialogs for Programs, Combinations, Songs, Set Lists, Samples, Multisamples, Wave Sequences, Drum Kits, Effects, MOD-7 algorithms, and KARMA GEs.

## Using the Favorites check-box

The Bank and Category select pop-ups both include a **Favorite** check-box at the bottom of the screen. This lets you trim the list to show only Programs you've marked as favorites.

If the selected Bank or Category contains no Programs marked as Favorites, the check-box will be grayed out and unavailable. When shipped from the factory, no Programs will be marked (we leave that up to you, since they should be *your* favorites!).

To mark a Program as a Favorite:

1. Go to the Program P0: Play page.
2. Touch the Favorite box, underneath the Tempo parameter, so that the box is filled in with a red square (this shows that the box is "checked").
3. Write the Program.

This is an important step. If you don't write the Program, the change to the Favorites check-box won't be retained.

For details on how to write Programs, see "Saving your edits" on page 46.

## Using a footswitch to select Programs

You can assign a footswitch to step through Programs one by one, either going up (0, 1, 2, 3, etc.) or going down (3, 2, 1 etc.). This lets you change Programs without using your hands—great for quick Program changes in live performance situations.

There are two ways of doing this: by assigning the footswitch to Program Up/Down, or to Value Inc/Dec. Program Up/Down is recommended for normal use, while Value Inc/Dec is a special-purpose setting, as described below.

**Note:** These settings apply to Set Lists and Combinations, as well.

### Assigning the footswitch to Program Up/Down

Assigning the footswitch to Program Up or Program Down lets you directly control Program changes from the footswitch.

To set this up:

1. **Connect a foot switch to the rear-panel ASSIGNABLE SWITCH input.**
2. **Press the GLOBAL button to enter Global mode.**
3. **Go to the Controllers tab of the Controllers/Scales page.**
4. **Set the Foot Switch Polarity parameter to match the connected switch.**
5. **At the top of the page, set the Foot Switch Assign parameter to Program Up (or Program Down).**

For this setting to persist after power-down, you need to write the Global settings.

6. **Open the menu, and select the Write Global Setting command.**

The Write Global Setting dialog will appear.

7. **Press OK, and then OK again to confirm.**

Now, when you return to Program mode, the foot switch will step through the Programs one by one.

### Assigning the footswitch to Value Inc/Dec

This lets you use the Assignable Foot Switch to duplicate the functions of the front-panel Inc  $\triangle$  or Dec  $\nabla$  buttons.

This is a special-case setting, but it may be convenient if you like to keep the Bank or Category select windows open as you play, so that you can see the list of available Programs or Combinations. While the window is open, the Program Up/Down assignments still change sounds as usual, but the window does not update to show the currently selected sound. However, assigning the Foot Switch to the Inc or Dec button lets you step through the items in the list, one by one—just like pressing the front-panel buttons.

To set this up:

1. **Follow steps 1-4 under “Assigning the footswitch to Program Up/Down,” above.**
2. **At the top of the page, set the Foot Switch Assign parameter to Value Inc (or Value Dec).**

For this setting to persist after power-down, you need to write the Global settings.

3. **Open the menu, and select the Write Global Setting command.**

The Write Global Setting dialog will appear.

4. **Press OK, and then OK again to confirm.**

Now, the foot switch will act just like pressing the front-panel Inc or Dec button.

**Note:** The footswitch will work like this for the entire KRONOS—not just when the Program or Combination Select window is open.

### Assigning incoming MIDI CCs to Program Up/Down or Value Inc/Dec

In addition to using the built-in footswitch input, you can also map incoming MIDI CCs to Program Up/Down or Value Inc/Dec. This allows you to assign multiple switches

to the different functions—for instance, one for Program Up and a second for Program Down—using an external MIDI or USB MIDI foot controller. For more information, see “2-3: Function Assign” on page 784 of the Parameter Guide.

---

## Selecting Programs via MIDI

You can select any Program from any bank by using MIDI Program Change messages in conjunction with MIDI Bank Select messages. When you select Programs from the front panel, the appropriate MIDI messages are sent automatically (unless MIDI filters are active; see below).

If you are entering the MIDI messages manually into a sequencer, note that the Bank Select message needs to come before the Program Select message.

### In Program mode, use the Global MIDI Channel

With the exception of the Drum Track, all transmission and reception of MIDI data in Program mode is performed on the Global MIDI Channel. You can set this on the Global mode P1 MIDI page.

### Bank Map

Bank Select messages can work in one of two ways, as controlled by the Bank Map parameter on the Global P0 Basic Setup page. The factory default setting will work for most standard applications, and most people will never need to change it. If you use General MIDI sequences, the alternative GM(2) setting may be helpful. For more information, see “Bank Map” on page 755 of the Parameter Guide.

### MIDI filters

You can use MIDI filters to control whether or not Program Change and Bank Select messages will be transmitted and/or received. The filters are set up on the Global mode P1 MIDI page. For more information, see “1-1c: MIDI Filter” on page 776 of the Parameter Guide.

### KRONOS Plug-In Editor

The KRONOS Plug-In Editor includes support for patch lists, allowing you to select Programs, Combinations, Songs, and Set Lists Slots by name from within your DAW software of choice.

---

## General MIDI Programs

Internal bank G contains a full set of General MIDI 2 Programs, as well as sub-banks g(1)–g(9) (GM2 variation programs), and bank g(d) (drums).

When you select Programs using the Bank or Category windows, you’ll notice that a **Variation** button appears when you select bank INT-G. Each time you press this button, or repeatedly press the front-panel INT-G button, you’ll step through the General MIDI banks in the following order: G→g(1)→g(2)...g(8)→g(9)→G...

## Using Controllers

The KRONOS provides a lot of hands-on ways to control the sound—the mod and pitch-bend joystick, the Vector joystick, the ribbon controller, two switches (SW1 and SW2), and the Control Surface knobs, sliders, and switches.

These controls let you modify the tone, pitch, volume, effects, etc. in realtime while you play.

### Joystick

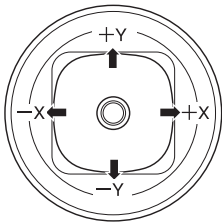

The joystick moves in four directions: left, right, forwards (away from yourself), and backwards (towards yourself). Each of the four directions can be used to control a different function, such as modulating Program or effects parameters. These assignments can be different for every Program, but generally, they do the following:

*Standard Joystick functions*

Move the joystick...	Controller Name	Normally controls...
Left	JS-X	Pitch bend down
Right	JS+X	Pitch bend up
Forwards (away from yourself)	JS+Y	Vibrato
Backwards (towards yourself)	JS-Y	Filter LFO (wah)

### Joystick Lock

The joystick is spring-loaded, so that it automatically returns to the center position when you let go.

However, you can use either of the two front-panel switches (SW1 or SW2), or a foot-switch, to “lock” the current position of the joystick. This leaves your hands free to play on the keyboard, or to use other controllers. For more information, please see “Using the Lock function” on page 36.

### Vector Joystick

The Vector Joystick lets you control the volume balance between OSC1 and OSC2, and can also generate CC messages to modulate Program and effects parameters.

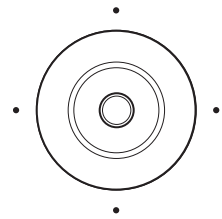

In Combi and Sequence modes, the Vector Joystick can do all of this, plus balance the volumes of the different Programs in the Combi.

The Vector Joystick does all of this in conjunction with the Vector Envelope, which is a flexible, multi-segment envelope with a few interesting twists. For more information, see “Using Vector Synthesis” on page 60.

### Resetting the Vector Joystick to the center

You can use the front-panel RESET CONTROLS button to reset the Vector Joystick’s output value to its default center position. To do this:

1. **Hold down the RESET CONTROLS button.**
2. **While holding RESET CONTROLS, move the Vector Joystick.**
3. **Release the RESET CONTROLS button.**

The joystick’s output value will now be reset to the center position.

### Ribbon Controller

Move your finger to the left and right on the ribbon controller to apply an effect.

Normally, this is used to control pitch, volume or filter etc.

You can use the Lock function of SW1 or SW2 keys to hold the effect even after you release your finger from the ribbon controller. For more details, see “Using the Lock function” on page 36.

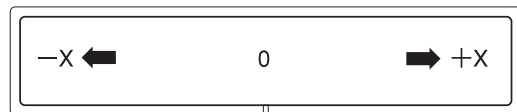

### SW1 and SW2

These are the two switches above the joystick and ribbon.



You can use SW1 and SW2 to control program parameters via AMS (Alternate Modulation), or effect parameters via DMod (Dynamic Modulation).

They can also transpose the keyboard by octaves, turn portamento on/off, or lock the modulation values of the ribbon controller, joystick, or aftertouch.

Each switch may work as either as a toggle or a momentary switch. In **Toggle** mode, each press alternates between on and off; in **Momentary** mode, the switch only changes for as long as you hold it down.

Each Program, Combination, and Song stores its own settings for what the switches will do, and whether each switch is on or off (based on their current states when the Program, Combination, or Song is saved). You can also make settings for Sampling mode as a whole.

In Program mode, you can check the assignments of SW1 and SW2 on the Play page Assignment tab.

In all modes, you can edit the assignments for SW1/2 on the Set Up Controllers page.

Programs (HD-1 and EXi)	P1: Basic/Vector
Combinations and Songs	P1: EQ/Vector/Controller
Sampling mode	P4: EQ/Controller

When using SW1/2 for AMS or Dmod, the default settings are SW1 Mod.:CC#80 and SW2 Mod.:CC#81.

For an example, see “Using Dmod to change the feedback level via SW1” on page 221. For a complete list of the possible assignments, see “SW1/2 Assignments” on page 1109 of the Parameter Guide.

*Note:* If you wish to keep these settings after the power is turned off, you must save the Program, Combination, or Song. Settings for Sampling mode cannot be saved.

*An example of settings in a Program*

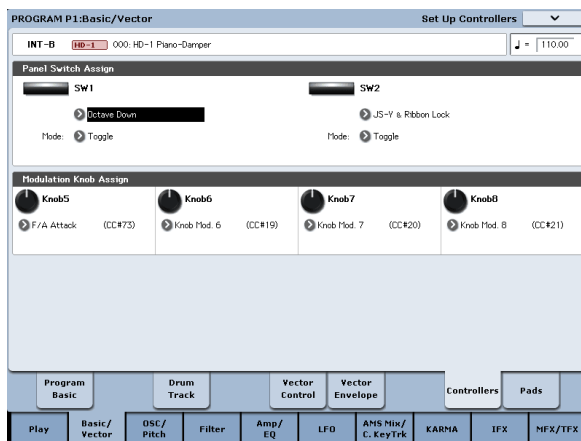

## Using the Lock function

### Locking the Joystick

1. Using the factory sounds, select Program **USER-C044: Real Suit E.Piano**, and play the keyboard.
2. Move the joystick away from yourself (the +Y direction).

The vibrato effect will deepen.

3. While holding the joystick away from yourself, press the SW2 switch.

When you press the switch, its LED will light up, and the modulation effect at this point will be maintained.

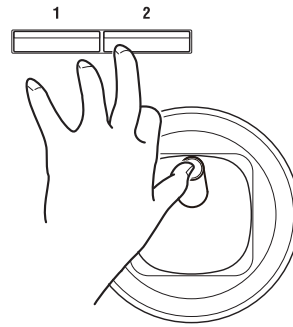

4. Release the joystick, and play the keyboard.

The modulation will stay the same as it was when SW2 was pressed. Moving the joystick away from yourself will not affect the sound.

5. Press the SW2 key once again to release the Lock function.

### Locking the Ribbon Controller

1. Select Program **USER-C044: Real Suit E.Piano**.
2. Press the SW2 key.

The LED on SW2 will light up.

3. Touch the ribbon controller, and move your finger left and right.

Movement in the +X direction will brighten the tone, and movement in the -X direction will darken the tone.

4. Lift your finger up from the ribbon controller.

The sound will remain as it was when you last touched the ribbon.

5. Press the SW2 key once again to release the Lock function.

6. Press the tab labeled **Cntrl/View Effect**, to go to the Controller/View Effect page.

In the upper right-hand portion of the screen, notice that SW2 is assigned to **JS Y & Ribbon Lock**, and is set to **Toggle**. This means that SW2 is assigned to control the Lock function for both the joystick’s Y axis and the ribbon controller. Many Programs and Combinations use this assignment.

You can also lock both the ribbon and the joystick at the same time:

1. Move the joystick in the +Y direction
2. Press the SW2 key to turn on the Lock function.
3. Move your finger on the ribbon controller.
4. Release the joystick, and lift your finger up from the ribbon.

The effects of both the ribbon and the joystick will be maintained until you press SW2 again to release the lock.

Lock can also be applied to aftertouch, by assigning SW1 or SW2 to **After Touch Lock**.

For details on the functions that you can assign to SW1 and SW2, please see the “SW1/2 Assignments,” on page 1109 of the Parameter Guide.

You can also map incoming MIDI CCs to any of the lock functions; see “2–3: Function Assign” on page 784 of the Parameter Guide.

## Control Surface knobs, sliders, & switches

The Control Surface has 8 knobs, 8 sliders plus a master slider, and 16 switches. You can use these for many different tasks:

- Controlling mixer features, including volume, pan, EQ, FX sends, mute, and solo
- Modulating and editing sounds
- Controlling KARMA
- Controlling external MIDI devices

You can switch the Control Surface between its different functions using either the on-screen tabs on the Control Surface page (the left-most tab on P0 Play), or the front-panel Control Assign switches. The tabs and the front-panel switches mirror one another; when you change one of them, the other changes as well.

In Program mode, you can select one of five different functions:

**TIMBRE/TRACK** lets you adjust the volume, pan, and send levels for Oscillators 1 and 2, along with the Program EQ (plus similar controls for the Drum Track, with the exception of pan). In Combi and Sequence modes, you can also use this to select two different banks of Timbres or Tracks, as shown by the LEDs to the right of the switch.

**AUDIO (INPUTS)** lets you adjust the volume, pan, and send levels for the analog, S/P DIF, and USB audio inputs. In Sequence mode, you can also use this to select two banks of hard-disk recording tracks, as shown by the LEDs to the right of the switch.

**EXT** (External) lets you send MIDI messages to external MIDI devices.

**RT KNOBS/KARMA** (“RT” stands for Realtime) lets you modulate sounds and effects with the knobs, and control KARMA with the sliders and switches. For more details, see “Editing sounds & effects with the Realtime Knobs” on page 43.

**TONE ADJ/EQ** (Tone Adjust/EQ) gives you hands-on access to sound editing, using the sliders, knobs, and switches. For more details, see “Using Tone Adjust” on page 45.

You can freely change back and forth between the different functions, without losing any of your edits.

### Resetting controls to their saved values

The front-panel **RESET CONTROLS** button lets you recall the stored or default settings for any slider, knob, or switch on the control surface.

To reset a single knob, slider, or switch:

1. **Hold down the RESET CONTROLS button.**
2. **While holding down RESET CONTROLS, move a slider or knob, or press one of the control surface buttons.**

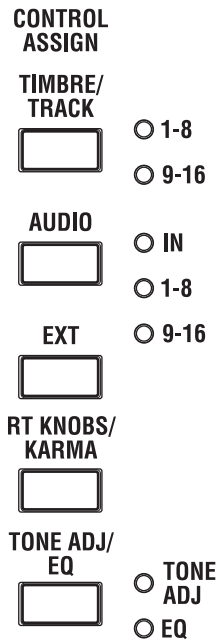

The slider, knob, or switch will be reset to the value stored in the Program (or, if applicable, the default value).

3. **When you’re done, release the RESET CONTROLS button.**

To reset a group of controls at once:

1. **Make sure that the Control Surface is showing the parameters you want to reset.**

As a safety precaution, you can only reset the parameters currently displayed on the Control Surface. This takes into account both the current Control Assign setting, and the MIXER KNOBS button.

For instance, if you want to reset the volume and pan for both Oscillators, make sure that Control Assign is set to TIMBRE/TRACK, and that MIXER KNOBS is set to INDIVIDUAL PAN.

2. **Hold down the RESET CONTROLS button.**

3. **While holding down RESET CONTROLS, press the current Control Assign button again.**

All of the sliders, knobs, and switches in the Control Assign group will be reset to the values stored in the Program.

You can also reset all of the faders and switches in the KARMA module, by holding RESET CONTROLS and then pressing the KARMA MODULE CONTROL button. Similarly, to reset a single KARMA Scene, hold RESET CONTROLS and press any of the SCENE buttons.

Finally, you can also use this to clear all solos, by holding RESET CONTROLS and then pressing the SOLO button.

For more information, see “RESET CONTROLS” on page 22 of the Parameter Guide.

## VALUE slider

When a program number is selected in Program P0: Play page, or when a combination number is selected in Combination mode page P0: Play page, you can use the VALUE slider to modulate Program and effects parameters.

## Keyboard

### Velocity

Velocity is a measure of how hard you play a note on the keyboard. This can be used to modulate many different aspects of the sound, such as volume, brightness, or the character of the attack.

### After Touch

The keyboard can also measure how hard you press down after you play a note—hence the term “after touch.” You can use this to shape notes over time, controlling (for instance) volume or vibrato amount.

### Note Number

Sounds can be programmed to change in character based on the note being played. As you play higher or lower on the keyboard, the note number can modulate the timbre—such as becoming brighter as you play higher. Envelopes may also become faster or slower; the volume may change; and so on.



### Foot Pedals and Switches

#### Damper Pedal (Sustain)

The damper pedal is also sometimes called the sustain pedal. It acts like the similarly-named pedal on an acoustic piano; when you hold down the pedal, notes will continue to sustain even when you lift your hands off of the keyboard.

#### Damper Switch vs. Half-Damper

You can use either a standard footswitch (such as the Korg PS-1) or a special half-damper pedal (such as the Korg DS-1H) as the Damper.

If you use a footswitch, it will work like a normal synthesizer sustain pedal: notes will sustain forever, as long as the pedal is held down.

A half-damper pedal is a special type of continuous foot pedal (normal foot pedals won't work properly for this application). It offers more subtle control of sustain, which can be especially useful for piano sounds.

The off and full-on positions of the half-damper work just like the footswitch, but intermediate positions modulate the release time to increase sustain without making it infinite.

The KRONOS will automatically sense when a half-damper is connected to the rear-panel DAMPER input. For proper operation, you will also need to calibrate the pedal, using the Calibrate Half-Damper command in the Global page menu.

#### Damper and MIDI

The Damper Pedal is sent and received as MIDI CC #64. In Combi and Sequence modes, you can "filter" CC# 64 so that it only affects some of the sounds in the Combi or Song.

#### Assignable Foot Switch

This lets you use a simple footswitch, such as the Korg PS-1, as an assignable controller. The footswitch can perform a wide variety of functions, such as:

- An assignable source for modulating sounds and effects
- Portamento on/off
- Una Corda on/off (convenient for the SGX-2)
- Program select up or down
- Sequencer start/stop or punch in/out
- Tap Tempo
- KARMA on/off, Latch on/off, or Scene select
- Drum Track on/off
- Chord SW
- Duplication of many front panel controls, including the modulation joystick, ribbon, value slider, Real-Time Knobs, SW 1/2, the pads, KARMA sliders, or KARMA switches

The switch's function is set in Global mode (on the Controllers tab of the Controllers/Scales page), so that it always works the same regardless of the current Program, Combi, or Song.

For more information, please see "Setting up the Assignable Switch and Pedal" on page 171.

#### Assignable Foot Pedal

This lets you use a continuous controller pedal, such as the Korg EXP-2 foot controller or Korg XVP-10 EXP/VOL pedal, as an assignable controller.

Like the Assignable Foot Switch, described above, the Foot Pedal can be used for many different functions, including:

- Master Volume
- Channel Volume, Pan, or Expression
- Assignable sound modulation, as several different AMS or Dmod sources (convenient for CX-3 expression)
- Effects Send level control
- Duplication of many front panel controls, including the modulation joystick, ribbon, value slider, Real-Time Knobs, or KARMA sliders

The pedal's function is set globally (on the Controllers tab of the Controllers/Scales page), so that it always works the same regardless of the current Program, Combi, or Song. For more information, please see "Setting up the Assignable Switch and Pedal" on page 171.

## Using the Chord Pads

### Overview

Programs, Combinations, and Songs all have a Pads page on the ninth tab of P1:

**Programs:** Basic/Vector->Pads

**Combinations and Songs:** EQ/Vector/Controller->Pads

You can use these pads for:

- Storing and selecting chords for Chord mode
- Selecting and triggering chords, especially for use with KARMA
- Playing drum sounds, especially in conjunction with a compatible USB MIDI pad device

The pads can play up to eight-note chords—and they even remember the velocities of the individual notes within the chord.

In addition to playing sounds directly, the pads are also used to select chords for Chord mode. For more information, see “Using Chord mode” on page 40.

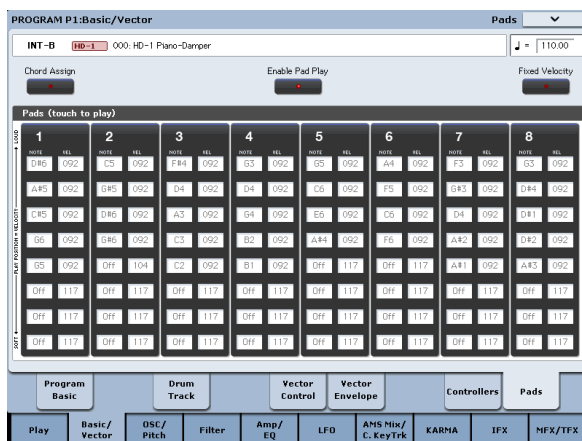

To avoid damaging the display, use care when playing the on-screen pads. Do not press strongly on the display or strike forcefully; instead, use a light and precise touch. “Velocity” is controlled by position, and not by force.

### Playing the pads

#### Playing the pads from the screen

You can play the pads directly from the screen. “Velocity” is controlled by where you touch the pad; lower is softer, and higher is louder. (You can also enable Fixed Velocity mode; see “Fixed Velocity” on page 40.)

If individual notes in the chord have different stored velocities, these are scaled by the overall velocity.

*Note:* from the screen, only one pad can be played at a time.

#### Playing the pads from MIDI or the keyboard

Pads can be triggered by incoming MIDI notes or CCs, or from the local keyboard. To do so:

1. Go to the Global P2: Controllers page.
2. Under MIDI CC# Assign — Vector Joystick / Pads, set Pads 1-8 to the desired MIDI notes.

You can also use MIDI CCs, if you prefer. With CCs, the value of the CC is used as the pad’s “velocity.” (For an alternative method, see “Playing the pads from external MIDI CCs,” below.)

It’s as simple as that; the pads will now respond to the specified notes or CCs on the Global channel.

Be aware, however, that this will completely dedicate these notes to triggering the pads; they will no longer trigger sounds normally. For this reason, you may wish to assign notes either below or above the standard keyboard range (for instance, C-1 through G-1).

All of this also applies to notes played on the Global Channel from the local keyboard, with the same restriction: the assigned notes become dedicated to playing the pads.

For more information, see “2-1c: MIDI CC# Assign — Vector Joystick / Pads” on page 782 of the Parameter Guide.

### Playing the pads from external MIDI CCs

The method above applies to both the local keyboard and MIDI input on the Global Channel. As an alternative, you can use the Global Function Assign page to play the pads from MIDI or USB MIDI input only, without affecting the local keyboard. This alternative method also allows you to control the pads from any MIDI Channel—not just the Global channel.

For more information, see “2-3: Function Assign” on page 784 of the Parameter Guide.

### Playing the pads from Korg USB MIDI controllers

You can also play the pads using Korg USB MIDI controllers equipped with drum pads, including:

- nanoPAD and nanoPAD2
- microKONTROL
- padKONTROL
- KONTROL49

To use any of these Korg controllers, simply connect the controller to one of the KRONOS’s two USB A ports. The KRONOS will automatically determine the MIDI assignments of the controller’s pads 1-8, and map them directly to the KRONOS pads.

For more details, see “USB MIDI controllers” on page 1132 of the Parameter Guide.

### Enable Pad Play button

The pads play every time you touch within their boundaries. If you’re editing the stored notes and velocities manually, you may wish to temporarily disable this feature. To do so:

1. Touch the Pad Play button at the top of the display, to turn it off.

The button’s light will go dark, to show that it is disabled.

Once you’re finished editing, turn it on again:

2. Touch the Pad Play button again, to turn it on.

The button’s light will go on, to show that it is enabled.

*Note:* Enable Pad Play applies only to the on-screen pads, and does not affect pad triggering from MIDI, the local keyboard, or USB MIDI devices.

---

### Assigning notes and chords to pads

You can assign single notes and chords to the pads in three different ways.

#### Play the notes, and then press Chord Assign

1. Play a single note, or a chord of up to 8 notes.
2. Press the Chord Assign button.
3. Press the pad to which you'd like to assign the notes.

That's it! The notes are now assigned to the pad.

#### Press Chord Assign, and then play notes

This method lets you create a chord out of widely-spaced notes, even if you can't play all of the notes simultaneously.

1. Press the Chord Assign button.
2. Play a single note, or a chord of up to 8 notes.

You can play a single note, or a simple chord.

If you like, you can also play up to 8 notes as a legato phrase. As long as you take care that the notes overlap each other, the entire phrase will be recorded as a single chord. You can take as long as you like to play the phrase.

3. Press the pad to which you'd like to assign the notes.

After pressing the pad, you're done!

#### Editing notes and velocities

Once assigned, you can edit the recorded notes and velocities. If you like, you can also enter new notes this way, by manually entering them as parameter values. For more information, please see "1–9: Pads" on page 54 of the Parameter Guide.

---

### Copying pads

Copying one pad to another is just like assigning notes from the keyboard.

As with assigning notes to the keyboard, you can either play the pads first, or press Chord Assign first. In the interest of saving space and time, only the first method is described below.

---

## Using Chord mode

---

### Overview

Chord mode lets you choose one of the chords assigned to the pads, and then play it from the keyboard. The chord is transposed according to the note that you play; the played note specifies the lowest note of the chord, and the higher notes are transposed to match. As when playing chords from the Pads themselves, each note in the chord can have a different stored velocity, scaled by the played note.

In addition to using the on-screen parameters, you can turn Chord mode on and off via SW1/2 or the Foot Switch, and change chords simply by pressing the pads. In Combination and Sequencer modes, you can make these settings for each Timbre or Track, as desired. Naturally, you can control all of this via MIDI as well.

Chord mode can duplicate the way that similar features worked on classic analog synths (such as the original Polysix), but it can also use all of the Voice Assign options to

### Copying notes from one pad to another

To copy the note assignments from one pad to another:

1. Press and release the pad whose notes you want to copy.
2. Press the Chord Assign button.
3. Press the pad to which you'd like to copy the notes.

The new pad will now play the same notes as the original pad.

### Merging two or more pads together

Using the on-screen pads, only one pad can be played at a time. When using MIDI, the keyboard, or a Korg USB MIDI pad controller, however, multiple pads can be played at once. You can use this to merge together the assignments from two or more pads, as long as the total number of notes is 8 or fewer. To do so:

1. Play and hold all of the pads that you'd like to merge, so that they're all sounding at the same time, and then release them.

All of the pads must be held down at the same time.

2. Press the Chord Assign button.
3. Press the pad to which you'd like to copy the notes.

You can even use one of the pads that was being merged, if you like. After pressing the destination pad, you're done.

---

### Fixed Velocity

Each pad stores a velocity level for each of its 8 notes. The **Fixed Velocity** button, on the display above the pads, controls whether or not the pads respond to the touch location.

When **Fixed Velocity** is on, the pads always use their stored velocity settings, regardless of where you touch the pad.

When **Fixed Velocity** is off, touching the top of the pad produces the preset velocities. When you play lower on the pad, the preset velocities are scaled down accordingly, maintaining the balance between the notes in the chord.

---

create different effects—such as mono legato chords with fingered portamento, or poly chords that overlap one another.

Finally, note that you don't have to use Chord mode to play full chords; you can also use it to create more subtle effects, such as stacked octaves or fifths. You can even adjust the relative levels of these additional pitches via the stored velocities of the individual chord notes.

---

### Chord Switch

The Chord Switch (abbreviated **Chord SW**) lets you turn Chord mode on and off via SW1/2 or the Foot Switch.

**Important:** Programs will only respond to the **Chord SW** if their Chord parameter has been set to either **Basic** or **Advanced**. If it's set to **Off**, then the switch will have no effect.



### Assigning SW1/2 to control Chord on/off

Within any individual Program, Combi, or Song, you can set either SW1 or SW2 to turn Chord mode on and off. To do so:

1. In the Program, Combi, or Song, go to the Set Up Controllers page.
2. Select Chord SW as the assignment for SW1 or SW2.

### Assigning the Foot Switch to control Chord on/off

You can also assign the Foot Switch to turn Chord mode on and off, so that you don't need to move your hands from the keyboard while performing. This setting will apply globally, regardless of the current Program, Combi, or Song. To do so:

1. Go to the Global Foot Switch Assign page.
2. Select Chord SW for the Assignable Foot Switch.

## Enabling Chord mode

### Program mode

To enable Chord mode for a Program:

1. Go to the Program Basic page
2. Set the Chord parameter to Basic (Bsc) or Advanced (Adv).

Once you've selected either **Basic (Bsc)** or **Advanced (Adv)**, Chord mode is enabled immediately. Optionally, you can then turn Chord mode off and on via the **Chord SW**, using either SW1/2 or the Assignable Foot Switch.

If you set **Chord** to **Off**, then it will always remain off, regardless of the **Chord SW**. This is particularly useful in Combi and Sequencer modes, since it allows you to create splits and layers in which some Timbres/Tracks use Chord mode, but others do not.

### Combination and Sequencer modes

To enable Chord mode for a Timbre in a Combi, or a track in a Song:

1. Go to page 2-2 OSC (under Timbre Parameters or Track Parameters, respectively).
2. Set the Timbre/Track's Chord parameter to **Basic** or **Advanced**.

Alternatively, you can set the Timbre/Track to **PRG**. This is the default, which uses the setting from the Program. Note that if the Program's Chord mode is set to **Off**, the Timbre/Track will not respond to the Chord Switch.

### What if Timbres/Tracks share the same channel, but have different Chord settings?

If Timbres/Tracks share the same channel, but have different Chord settings, then the Chord SW affects each Timbre/Track individually, as below:

	Stored Setting		
	Off	Basic	Advanced
<b>Chord SW = On</b>	Off	Basic	Advanced
<b>Chord SW = Off</b>	Off	Off	Off

### Example setup: keyboard split

To create a split with a single-note bass in the left hand, and a chord on the right:

1. Select a bass Program for Timbre 1, and a piano Program for Timbre 2.

2. Set Timbre 1's Chord to **Off**, and Timbre 2's Chord to **Basic**.

Now, the Chord SW will enable/disable the chord for the right hand only.

### Details: initial state of Chord on/off

Normally, when you select a Program, Combi, or Song, Chord mode will be on or off as set by the **Chord** parameter.

The exception is when SW1 or SW2 is assigned to the Chord Switch. In this case, the stored on/off state of SW1/2 controls whether Chord mode will be on or off by default.

Note that this default state is slightly more complex in Combination and Sequencer modes:

- In Combination mode, SW1/2 affect only Timbres on the Global channel. Other tracks will be as set by their Chord parameters.
- In Sequencer mode, SW1/2 affect only the Tracks on the same channel as the current Keyboard Track. This determines the initial state when a Song is first selected, since the current Keyboard Track is stored with the Song. Other tracks will function as set by their Chord parameters.

## Basic and Advanced modes

There are two "on" settings for Chord mode: **Basic (Bsc)** and **Advanced (Adv)**.

**Basic** re-creates the chord mode of the original Polysix. Each time you play a new chord, it will cut off the previous chord. This option ignores the Voice Assign settings.

**Advanced** uses the Program's Voice Assign parameters to create a variety of different effects, such as mono legato chords with fingered portamento, or poly chords that overlap one another. The Voice Assign settings apply as if the entire chord was a single note, with each pitch in the chord created by an additional transposed oscillator.

**Poly, Poly Legato, Single Trigger, Mono, Mono Legato, Mono "Mode," Legato Offset, Mono Priority, and Mono and Poly Unison** all apply.

You can achieve the same effect as **Basic**, above, by setting **Chord** to **Advanced**, **Voice Assign** to **Mono**, **Priority** to **Last Note**, and **Legato** to **Off**.

## Creating and editing chords

Chords are assigned to the pads, stored, and edited as described under "Using the Chord Pads" on page 39.

## Selecting chords

The Chord function uses the chords assigned to the Pads. To select a chord to play from the keyboard (or via MIDI):

1. Select the desired Pad from the Source pop-up menu or:  
When Chord is enabled, play a Pad using any of the methods described under "Playing the pads" on page 39.

When Chord mode is enabled, playing a Pad edits the **Source** parameter. The Pad will not play any sounds by itself; it only selects the chord to be played from the keyboard.

Chord mode is enabled when the Chord SW is either unassigned or turned On, and...

- In Program mode, **Chord** is set to **Basic** or **Advanced**
- In Combi mode, **Chord** is set to **Basic** or **Advanced** on any Timbre (with Status set to **INT**) on the Global channel
- In Sequencer mode, **Chord** is set to **Basic** or **Advanced** on any Track (with Status set to **INT** or **BTH**) on the same MIDI channel as the current Keyboard Track

In Combi mode, selection via the Pads affects all Timbres on the Global Channel. In Sequencer mode, this affects Tracks on the same MIDI channel as the current Keyboard Track.

### What if Timbres/Tracks share the same channel, but have different Source settings?

If Timbres/Tracks share the same channel but have different Source settings, they will maintain the different settings as long as the Pads are not used to select a different chord. As soon as a Pad is used, all the Timbres/Tracks will be set to the same chord—unless they are set to **PRG**.

When Source is set to **PRG**, the Timbre/Track uses the Source chord stored in the Program, instead of any of the chords from the current Combi or Song. This makes it easy to use Chord mode for sound-specific effects, such as octaves, stacked fifths, and so on.

---

## Playing chords

The lowest note of the selected chord is transposed to match the note played on the keyboard. Higher notes are transposed accordingly. For instance, let's say that:

- The stored chord is F4, Bb4, and Eb5
- You play a D3 on the keyboard (or via MIDI)

In this case, the resulting chord will be D3, G3, and C4.

Just as with the Pads, the stored velocities are scaled by the velocity of the played note.

In Combi and Sequencer modes, as long as the root note of the chord is within the Timbre/Track keyboard zone, the entire chord will be played in that Timbre/Track—even if some of the notes extend beyond the Timbre/Track's key zone.

---

## Chords and MIDI

The **Chord SW** and **Source Pad** settings (including selections via the Pads) are transmitted and received via SysEx, which can be recorded and played back via internal or external sequencers.

In Combi and Sequencer modes, there are discrete SysEx messages per Timbre/Track for both **Chord SW** and **Source Pad**, so that each Timbre/Track can be set individually if desired. Note that this allows more flexibility than when using the local keyboard's **Chord SW** and Pads.

When the Chord SW or the front-panel Pads are used to change the chord state, separate messages are sent for each affected Timbre or Track, including:

- In Combi mode, each Timbre on the Global Channel
- In Sequencer mode, each Track on the same MIDI channel as the Keyboard Track

## Easy Program Editing

### Quick edits using the knobs, sliders, and switches

You can edit any of the Programs shipped with KRONOS, or you can start with an initialized Program to create sounds from scratch.

You can do many basic edits directly from the front panel Control Surface knobs, switches, and sliders, without ever delving deeper into the LCD interface. For instance, you can use the knobs to change attack and release times, make sounds brighter or darker, alter effects depths, modulate KARMA's phrase generation, and so on.

The knobs, sliders, and switches will do different things, depending of the Control Surface CONTROL ASSIGN setting. For editing Programs, the three important CONTROL ASSIGN settings are **TIMBRE/TRACK**, **RT KNOBS/KARMA**, and **TONE ADJ/EQ**.

**TIMBRE/TRACK** lets you adjust the volume, pan, and send levels for Oscillators 1 and 2 and the Drum Track, along with the Program EQ.

**RT KNOBS/KARMA** lets you modulate sounds and effects with the knobs, and control KARMA with the sliders and switches.

**TONE ADJ/EQ** (Tone Adjust) gives you hands-on access to more detailed sound editing, using the sliders, knobs, and switches.

Note: EQ is only available in Set List mode. For more information, see "Graphic EQ" on page 127.

#### Adjusting volume, Pan, EQ, and FX sends

In **TIMBRE/TRACK** mode, the Control Surface puts all of the basic mixing controls under your fingertips.

1. Press the **TIMBRE/TRACK** button under **CONTROL ASSIGN**.

The button's LED will light up.

2. Optionally, go to the **Control Surface** tab of the **Play** page.

This page mirrors the Control Surface. Often, it will show you a little more information about the knob assignments, exact values, and so on.

3. Press the **MIXER KNOBS** button until the **INDIVIDUAL PAN** LED lights up.

This makes knobs 1 & 2 control pan for OSC1 and OSC2, respectively.

4. Use sliders 1 ...3 to adjust the volumes of OSC1, OSC2, and the Drum Track.
5. Use knobs 1 & 2 to adjust the pan positions of OSC1 and OSC2.

The Drum Track's pan is controlled separately, in the Drum Kit itself.

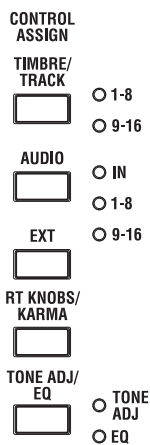

6. Press the **MIXER KNOBS** button until the **CHANNEL STRIP** LED lights up.

This makes the knobs control a virtual channel strip, including pan, EQ, and effects sends.



7. Use knobs 2-6 to adjust the Program's 3-band EQ.

The EQ affects both OSC1 and OSC2. Notice that the display shows you the gain values in dB, and the Mid Frequency in Hz. Also note that knob 2, **EQ Trim**, lets you compensate for gain changes caused by the EQ.



8. Press **SELECT** button 1.

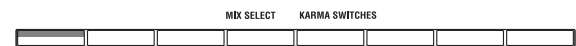

This selects OSC1. When the knobs are in **CHANNEL STRIP** mode, the selected Oscillator is important. While EQ always applies to both Oscillators, the **Pan** and **Effects Send 1/2** knobs affect only the selected Oscillator.

Notice that Pan is available, in different ways, with both settings of the **MIXER KNOBS** button.

9. Use knobs 7 and 8 to adjust Effects Sends 1 and 2 for OSC1.

Internally, the system figures out how the Oscillator is routed to the Master Effects, and automatically adjusts the appropriate send parameters.

#### Editing sounds & effects with the Realtime Knobs

The Realtime Knobs are a traditional feature of Korg workstations, combining modulation, quick edits, and hands-on control.

In **RT KNOBS/KARMA** mode, knobs 1-4 have dedicated functions, as printed on the front panel: Filter Cutoff, Filter Resonance, Filter EG Intensity, and Release Time. All of these correspond to standard MIDI CCs.

Knobs 5-8 can be assigned to a wide variety of functions, many of which also have corresponding MIDI CCs. Often (but not always), knobs 5 and 6 modulate synthesis parameters, knob 7 controls the depth of a chorus or other modulation effect, and knob 8 controls reverb depth.

### Real-Time Knob functions

Knob	MIDI CC	Normally controls...
1	74	Filter Cutoff Frequency
2	71	Filter Resonance
3	79	Filter EG Intensity
4	72	EG Release Time
5-6	Varies for each Program	
7	Often Chorus Depth - but can vary per Program	
8	Often Reverb Depth - but can vary per Program	

When you move a knob, it sends out the corresponding MIDI CC. Also, when the CC is received via MIDI or generated by KARMA, the knob value changes to match the CC value.

Generally, the knobs “scale” the Program’s internal settings. When the knob is in the center, the settings are as programmed. To move the settings to their maximum value, turn the knob all the way to the right; to move them to their minimum value, turn the knob all the way to the left.

#### Knob scaling

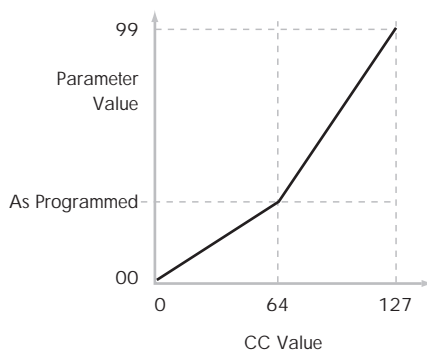

For example:

#### 1. Select Program USER-C 016, “Smooth Operators.”

This is an electric piano sound; let’s see what we can do to make it sound a bit different.

#### 2. Press the RT KNOBS/KARMA button under CONTROL ASSIGN.

The TONE ADJUST LED will light up.

#### 3. While playing the sound, turn knob 1 (Filter Frequency) to the right, slowly, to about 3 o’clock.

Notice how the piano becomes a sort of synth sweep.

#### 4. Next, turn knob 2 (Filter Resonance) to the right, also to about 3 o’clock.

#### 5. With knob 2 in that position, try moving knob 1 back and forth as you play.

With the resonance increased, it now sounds like you’re playing through a wah pedal.

Next, let’s say that you decide that’s not really what you wanted—so, we’ll set the knobs back to their default values. You could move them back to the straight-up, 12 o’clock position, and then adjust them so that they’re exactly in the middle, but there’s an easier way...

#### 6. Hold the RESET CONTROLS button.

#### 7. While holding RESET CONTROLS, move first knob 1, and then knob 2.

As you move the knobs, their values will be reset to the default, center positions.

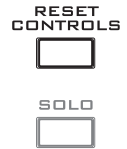

#### 8. Release the RESET CONTROLS button.

Now, you’re back to the original electric piano sound.

### Knob edits can be saved

The Real-Time Knobs are great for modulating sounds in performance, or for recording. If you like, you can also save the edited version of the sound, using the normal Write Program command (see “Saving your edits” on page 46).

Internally, a single knob usually affects several different parameters. When you write a Program, the edits are saved into the individual parameters, and not to the knob itself. After writing the Program, you’ll notice that the knobs have returned to their center positions—since the old “edited” values are now the new “saved” values.

### Assigning functions to REALTIME KNOBS 5–8

When the Control Surface CONTROL ASSIGN is set to RT KNOBS/KARMA, the four knobs on the right function as Realtime Knobs 5-8 (User 1-4). These can perform a number of different functions, such as modulating sounds or effects, adjusting effects send levels, and so on.

Each Program, Combination, and Song stores its own settings for what the knobs will do. You can also make settings for Sampling mode as a whole.

When using the knobs for AMS or Dmod, it’s important to understand that assignment is a two-step process. First, you assign the knob to send a MIDI controller, such as Knob Mod.1 (CC#17). Second, you assign that MIDI controller to modulate one or more Program or effects parameters.

For the first part of the above, use the mode’s Set Up Controllers page. For more information, See “SW1 and SW2” on page 35.

The default assignments for knobs 5-8 are Knob Mod.1 (CC#17), Knob Mod.2 (CC#19), Knob Mod.3 (CC#20), and Knob Mod.4 (CC#21), respectively. For a complete list of the possible assignments, see “Realtime Knobs 5–8 Assignments” on page 1110 of the Parameter Guide.

Here’s an example of how to set up knob 5 (User 1) to control a Program’s filter and amp EG attack time:

1. Press the PROG switch to enter Program mode.
2. Press the Basic/Vector tab, and then the Controllers tab above it, to go to the P1: Basic/Vector– Set Up Controllers page.
3. Press the Modulation Knob Assign “Knob 5” popup button, and choose F/A Attack.
4. Press the front-panel RT KNOBS/KARMA button (under CONTROL ASSIGN).
5. Turn knob 5 (USER 1) to control the filter and amp EG attack.

*Note:* If you wish to keep these settings after the power is turned off, you must save the Program, Combination, or Song.

## Using Tone Adjust

Tone Adjust lets you use all of the sliders, knobs, and switches on the Control Surface to edit Program parameters, like the knobs on an analog synth. Each physical control can be assigned to any one of a number of Program parameters.

The specific parameters available through Tone Adjust will vary depending on the type of Program. HD-1 Programs support a certain set of parameters; each EXi also has its own set of parameters. For more information, see:

“Common Tone Adjust Parameters” on page 32 of the Parameter Guide.

“HD-1 Tone Adjust Parameters” on page 33 of the Parameter Guide.

“AL-1: Tone Adjust” on page 222 of the Parameter Guide.

“CX-3: Tone Adjust” on page 245 of the Parameter Guide.

“STR-1: Tone Adjust” on page 294 of the Parameter Guide.

“MS-20EX: Tone Adjust” on page 321 of the Parameter Guide.

“PolysixEX: Tone Adjust” on page 336 of the Parameter Guide.

“MOD-7: Tone Adjust” on page 387 of the Parameter Guide.

“SGX-2: Tone adjust” on page 398 of the Parameter Guide.

“EP-1: Tone Adjust” on page 417 of the Parameter Guide.

### Editing HD-1 sounds

#### 1. Select Program USER-C 016, “Smooth Operators.”

#### 2. Press the TONE ADJ/EQ button under CONTROL ASSIGN.

The button’s LED will light up.

#### 3. Go to the Control Surface tab of the Play page.

This page mirrors the Control Surface. It’s very useful with Tone Adjust, since it shows you the parameter assignments, exact values, and so on.

#### 4. Look at the assignments for sliders 5, 6, and 8.

Slider 5 is assigned to **Amp EG Attack**; slider 6 is assigned to **Amp EG Decay**; and slider 8 is assigned to **Amp EG Release**.

#### 5. Raise each of the three sliders so that they are about 4/5 of the way to the top.

The LCD should show their values as between +60 and +70. In other words, you’ve just edited the amp envelope so that the attack, decay, and release are all much longer than they were before.

#### 6. Play a few notes.

Notice that the sound has changed from an electric piano into a soft pad. Next, let’s add just a bit of pitch modulation, to make the sound more rich.

#### 7. Look at the assignments for knobs 2 and 5.

Knob 2 is assigned to **Pitch LFO 1 Intensity**—in other words, the amount of pitch modulation from LFO1. Knob 5 is assigned to **LFO1 Speed**.

#### 8. Turn knob 2 ever so slightly to the right, so that the LCD reads +01 or +02.

#### 9. Turn knob 5 to the right, until about 2 o’clock, so that the LCD reads about 40.

#### 10. Play a few more notes.

The pitch modulation has added some shimmer to the sound. Now, maybe it could use a bit more edge...

#### 11. Look at the assignments for SELECT switches 1 and 2.

These are programmed to raise the **Filter Frequency** and **Filter Resonance**, respectively. Switches are just on/off, but you can set a specific value for the **On** position; notice the +10 and +40 in the switch’s value boxes.

#### 12. Press the two switches, one by one.

The sound now has a more interesting character, due to the filters. Since it’s brighter, we’ve also restored some of the electric piano character.

Pretty easy, huh? Note - depending on the parameter, you may sometimes hear glitches in the sound as you move the control.

### Changing parameter assignments

The factory Programs include default assignments of Tone Adjust parameters to the knobs, sliders, and switches. If you like, you can change any of the assignments. To do so:

#### 1. Go to the Control Surface tab of the Play page.

On this page, you can see the parameter assignments for each controller, such as **Filter EG Attack**, **Pitch Stretch**, and so on.

#### 2. Press the popup button next to one of the parameter assignments.

A popup window will appear, with a long list of parameters. You can tell various things about the selections, just from the way they appear in the list:

- Parameters which affect only OSC1 or OSC2 are prefixed with [OSC1] and [OSC2], respectively.
- Parameters which affect both Oscillators, but which are specific to HD-1 Programs, are prefixed with [OSC1&2].
- The other group of parameters, at the beginning of the list, are “Common.” That is, you can use them with most EXi Programs, as well as HD-1 Programs.
- Parameters can only be assigned to one Tone Adjust control at a time. If a parameter is already assigned, it’s grayed out.

#### 3. Select a parameter from the list.

The parameter is now assigned to the control. To cancel out of the list without making a change, just touch on the screen outside of the popup window.

### Editing EXi sounds

The PolysixEX works particularly well with Tone Adjust, so let’s take a look at it now.

#### 1. Select Program INT-C085: Polysix Strings.

This uses the PolysixEX.

#### 2. Under CONTROL ASSIGN, press the TONE ADJ/EQ button.

#### 3. Play the keyboard while moving sliders 1-4 and knobs 1-2.

Notice as the knob graphics on the display move as well. Sliders 1-4 control the envelope shape; knobs 1-2 control the filter cutoff and resonance.

#### 4. On the display, press the Control Surface tab.

This page shows the assignments and values for all of the sliders, knobs, and switches.

5. Press the **Main** tab to return to the main **Play** page.
6. Touch the **PolysixEX** graphic around the **Cutoff** and **Resonance** knobs.

The display jumps to the PolysixEX Main page.

7. **Experiment with playing while using the Control Surface sliders, knobs, and switches.**

Notice how the graphics respond, as well. You can also select a graphic control on the screen and edit its value using any of the data entry controls.

---

### Using COMPARE

When you're in the process of editing a sound, pressing the **COMPARE** button will recall the saved version of the sound, as it was before you started editing. To indicate that you are listening to the saved version, the button's LED will light up.

Pressing **COMPARE** again returns you to the version you are editing, and the LED will go out again.

If you edit while the **COMPARE** LED is lit, the key will again go dark and your previous edits will be lost.

### Resetting individual controls

The **RESET CONTROLS** button lets you revert an individual knob, slider, or switch to its saved setting. For more information, see "Resetting controls to their saved values" on page 37.

---

### Saving your edits

Once you've tweaked the sound to perfection, you'll want to save your work. To save your edits:

1. **Select the Write Program command from the page menu, at the upper right-hand corner of the screen.**

You can also call up this menu command by holding **ENTER** and pressing **0** on the numeric keypad.

This brings up a dialog box which allows you to save the Program. Optionally, you can also select a new location, change the Program's name, and assign it to a sound category (such as keyboard, guitar, etc.).

2. **Press the "T" button to bring up the text edit dialog.**

You can give the Program a descriptive name using the on-screen keyboard.

3. **After entering the name, press OK.**

The text edit window will disappear, returning you to the main Write dialog.

4. **Under "To" at the bottom of the dialog, press the popup button next to Program to bring up the save location dialog.**

5. **Select a location to save the edited Program.**

You can write to any location in banks **INT-A...F**, **USER-A...G**, and **USER-AA...GG**. To avoid overwriting the factory sounds, it's safer to use a slot in one of the empty User banks.

 **Important:** HD-1 Programs can only be written to HD-1 Banks, and EXi Programs can only be written to EXi Banks. For more information on the default Bank types, and on how to change them, please see "Program Bank Contents" on page 31, and "Changing the Program Bank Types" on page 31.

6. **After selecting the location, press OK.**

7. **Press OK again to start the write process.**

8. **If you're sure you want to write to this location, press OK again.**

After that, you're done!

For more information, see "Writing Programs and Combinations" on page 192.

 Do not turn off the power for at least 10 seconds after writing the Program. This allows the system time to complete the process, which includes saving a backup of the data to the internal disk.

### Saving edits to GM Programs

You can edit GM Programs, but you must then save them to a Bank other than **INT-G**; the GM Programs themselves cannot be over-written.

### Shortcut: SEQUENCER REC/WRITE

You can also use the **SEQUENCER REC/WRITE** button to quickly update the current Program, using the existing name, bank, number, and category. To do so:

1. **Press the SEQUENCER REC/WRITE button.**

The Update Program dialog will appear.

2. **Press OK to write the program.**

### Saving to disk

You can also save and manage Programs on the internal hard drive, and on USB storage devices. For more information, see "Saving to disks, CDs, and USB media" on page 196.

## Detailed Program Editing

### Editing HD-1 Programs

#### Creating your own Programs

You can create your own original HD-1 sounds by editing the factory Programs, or by initializing a Program and starting from scratch. You can save these Programs into any bank other than INT–G (which contains General MIDI Programs).

You can also create Programs using your own Multisamples, either from Sampling Mode or User Sample Banks. In addition, you can play a Program and resample your performance, or sample an external audio source while listening to the sound of a Program.

#### Overview of editing pages

P0: Play is where you select and play programs, make quick edits using the Control Surface, and adjust the KARMA settings. The other pages let you modify the sound in more detailed ways.

Page	Main features
P0: Play	<ul style="list-style-type: none"> <li>• Select and play Programs</li> <li>• Perform easy edits using the Realtime Knobs, KARMA sliders, and Tone Adjust</li> <li>• Adjust mix parameters including volume, pan, EQ, and send levels</li> <li>• Quick sampling and re-sampling</li> </ul>
P1:Basic/ Vector	<ul style="list-style-type: none"> <li>• Set the Program to Single, Double, Single Drum, or Double Drum</li> <li>• Select Mono or Poly voice allocation</li> <li>• Select a scale (e.g., Equal Temperament)</li> <li>• Set up controllers</li> <li>• Set up Vector synthesis</li> <li>• Set up the Drum Track</li> <li>• On-screen pads</li> </ul>
P2: Osc/Pitch	<ul style="list-style-type: none"> <li>• Select Multisamples, Wave Sequences, or Drum Kits</li> <li>• Settings related to the pitch, including the pitch EG.</li> </ul>
P3: Filter	<ul style="list-style-type: none"> <li>• Settings related to the filter (tone), including the filter EG.</li> </ul>
P4: Amp/EQ	<ul style="list-style-type: none"> <li>• Settings related to the amplifier (volume), including amp EG and pan.</li> <li>• Settings for the 3-band EQ</li> </ul>
P5: Common LFO	<ul style="list-style-type: none"> <li>• For each of the two LFOs provided for each oscillator, select the LFO type and speed, etc. (Settings in the pitch, filter, and amp pages determine how much the LFOs affect the sound.)</li> </ul>
P6: AMS Mixer/ Common Key Track	<ul style="list-style-type: none"> <li>• Mix and modify AMS sources using the two AMS mixers provided for each oscillator.</li> <li>• Set up how the Common Key Track output changes as you play up and down the keyboard</li> </ul>
P7: KARMA	<ul style="list-style-type: none"> <li>• Settings related to KARMA.</li> </ul>
P8: Insert Effects	<ul style="list-style-type: none"> <li>• Select insert effects and make settings for them. Specify send levels to the Master effects and routing to the outputs.</li> </ul>
P9: Master/ Total Effects	<ul style="list-style-type: none"> <li>• Select Master send effects and Total effects, and adjust their settings.</li> </ul>

For details on how to select the different pages, see “Basic operations” on page 17.

You can sample from within Program mode—including resampling the Program itself. For more information, see “Sampling in Program and Combination modes” on page 156.

You can also mix in live audio inputs, and process them through effects. For more information, see “Using effects with the audio inputs” on page 219.

Note that the page and parameter structures of EXi Programs are different than those of HD-1 Programs.

#### Basic HD-1 Structure

##### Multisamples and Wave Sequences

The sound of the HD-1 starts with one or more Multisamples. These can be recordings of instruments like piano, bass, guitar, strings, organs, analog synths, and so on, or purely digitally-created timbres.

You can play these Multisamples directly, or use them through Wave Sequences, which play a series of different Multisamples over time to create rhythms or complex, evolving timbres.

##### Oscillator Mode

HD-1 Single Programs have one oscillator, and Double Programs have two oscillators. Each oscillator includes a complete synthesis voice, with velocity-switched Multisamples, dual filters, EGs, LFOs, and so on.

Single and Double Drum modes are similar, but use Drum Kits (as created in Global mode) instead of Multisamples.

**Single** and **Single Drum** Programs use one oscillator, for a maximum of 140-note polyphony.

**Double** and **Double Drum** Programs use two oscillators, for a maximum of 70-note polyphony.

##### A note about polyphony

Polyphony means the number of notes that you can play at a time. This number will vary depending on the particular sound being played, and how that sound is produced.

Generally speaking:

- Double Programs use twice as many voices as Single Programs.
- Wave Sequences use twice as many voices as Multisamples.
- Stereo Multisamples use twice as many voices as Mono Multisamples, and Stereo Wave Sequences use twice as many voices as Mono Wave Sequences.
- If the Vector EG is enabled, the number of voices used increases slightly.



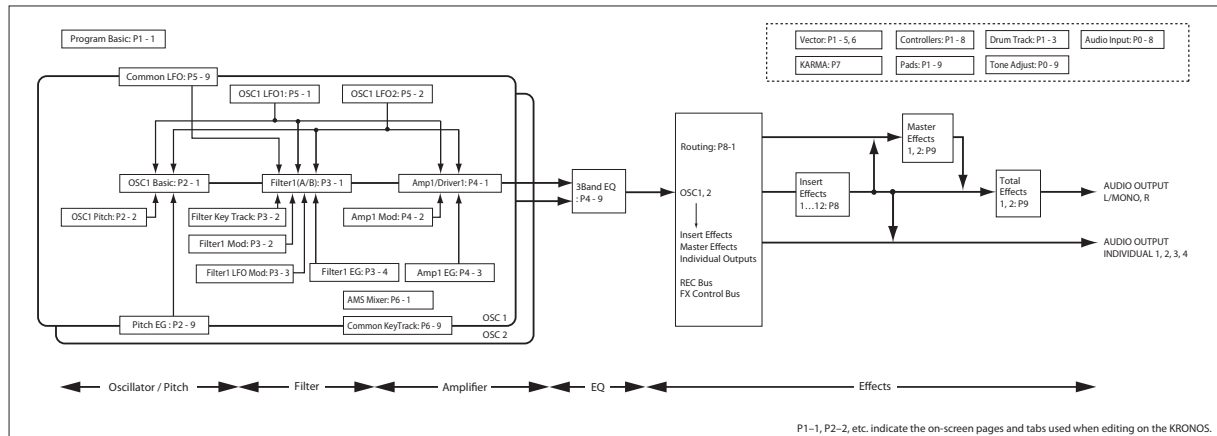

### Voice Assign Mode

The Voice Assign Mode selects whether the Program will play polyphonically (**Poly**) or monophonically (**Mono**).

When this is set to **Poly**, you can play both chords and melody lines. When this is set to **Mono**, only one note will sound even if you play a chord.

Normally you'll set this to **Poly**, but **Mono** is useful when playing sounds such as synth basses, synth leads, and other solo instruments. Try switching between Poly and Mono, and listen to the results.

### Using Drum Kits

You can create and edit Drum Kits in Global mode. For each note on the keyboard, you can select up to eight velocity-crossfaded Drumsamples, make filter and amp settings, and specify routing to the effects and to the individual audio outputs.

For more information, see "Using Drum Kits" on page 186.

In Programs, once you've set the **Oscillator Mode** to **Single** or **Double Drums**, you can select between the 152 user-programmable Drum Kits, plus an additional 9 GM2 kits. For more information on the factory sounds, see the Voice Name List.

### Copying settings between OSC1 & OSC2

Many of the Program parameters can be set differently for OSC1 and OSC2. These include all of the parameters on:

- All of the tabs on the OSC/Pitch page, except for the Pitch EG
- All of the tabs on the Filter page
- All of the tabs on the Amp page, except for EQ
- All of the tabs on the LFO page, except for Common LFO
- The AMS Mixer tabs

You can use the page menu's Copy Oscillator command to copy these parameters from one Oscillator to another. You can even copy parameters from an Oscillator in a different Program.

This command is useful when you want to set both Oscillators to the same settings, or when you want to duplicate settings you've used before.

### Working with Multisamples

As described above, the sound of the HD-1 starts with one or more Multisamples. You can play these Multisamples directly, or use them through Wave Sequences, which play a series of different Multisamples over time to create rhythms or complex, evolving timbres.

In Single and Double modes, each Oscillator can play up to eight Multisamples or Wave Sequences. In Single and Double Drums modes, each Oscillator plays a Drum Kit.

#### Multisamples, Wave Sequences, and Drum Kits

Multisamples, Drum Kits, and Wave Sequences allow you to play samples in different ways.

- Multisamples lay out one or more samples across the keyboard. For instance, a very simple guitar Multisample might have six samples—one for each string.
- Wave Sequences play back a series of different Multisamples over time. These Multisamples may crossfade to create smooth, evolving timbres, or change abruptly to create rhythms.
- As the name suggests, Drum Kits are optimized for playing Drumsamples.

#### Velocity splits, crossfades, and layers

As mentioned above, unless you're in Single or Double Drum mode, each Oscillator has eight velocity zones, named MS1 (the highest velocity) through MS8 (the lowest). This means that the Program can play different Multisamples or Wave Sequences, depending on how hard you play.

Each of these zones has separate settings for Level, Start Offset, and so on. Also, each of the zones can fade into the next, to create smooth velocity transitions. Zones can even be layered together, two at a time.

#### Selecting Multisamples

Let's create a simple velocity crossfade between two Multisamples, using just OSC1.

1. Go to the OSC1 Basic tab of the OSC/Pitch page.
2. Set the MS1 and MS2 Type parameters to Multi (Multisample).
3. Set the Types for MS3...8 to Off.
4. Select ROM Stereo as the Multisample Bank for MS1 and MS2.



There are four main types of Multisample Banks: **ROM, Sampling Mode, EXs, and User Sample Banks**. For each type, you can also choose between looking at mono and stereo Multisamples. Note that stereo Multisamples will require twice as many voices as mono Multisamples.

**ROM** Multisamples are the built-in “factory” sounds, and are always available. These are organized by category, such as pianos, guitars, bells, etc.

**Sampling Mode (Smp)** Multisamples are the ones that you can see and edit in Sampling Mode. These may include Akai, SoundFont 2.0, AIFF or WAV files loaded from disk, or native KRONOS samples (including third-party sound libraries and samples that you create yourself). Anything that can be used in Sampling Mode can also be loaded as a User Sample Bank.

**EXs** Multisample banks are PCM expansion sets created especially for the KRONOS. Each has its own unique number; for instance, the ROM Expansion is EXs1, and the Concert Grand Piano is EXs2. Only the currently loaded EXs banks will appear in this menu.

**User Sample Banks** bring the benefits of EXs to your own sample libraries. You can load and play gigabytes of your custom or converted samples at once, using Virtual Memory. They are shown as a path to a file on an internal disk, including the file name and the names of all enclosing directories. Only the currently loaded User Sample Banks will appear in this menu. For more information, see “User Sample Banks” on page 162 of the Operation Guide.

#### 5. Press the Multisample popup for MS1.

This brings up a list of Multisamples, organized by category. Use the tabs at the left of the screen to browse through the different categories.

6. Select a Multisample by touching its name in the list.

7. Press the OK button to confirm your selection.

8. Do the same for MS2.

Now that you’ve assigned Multisamples to MS1 and MS2, let’s set up the velocity ranges and crossfades.

9. Set MS2’s Bottom Vel (Velocity) to 001, and its Xfade Range to Off.

10. Set MS1’s Bottom Vel (Velocity) to 80.

Now, MS2 will sound when you play softly, at velocities of 79 or less—and MS1 will sound when you play harder, with velocities of 80 or more.

You can also see this split visually, in the graphic on the right side of the LCD.

11. Next, set MS1’s Xfade Range to 20, and its Curve to Linear.

Notice that the graphic now shows the two ranges tapering into one another. Between 80 and 100, MS2 will fade out, and MS1 will fade in, creating a gradual velocity transition instead of a hard split.

12. If you like, adjust the Levels for the two Multisamples.

#### Rev. (Reverse) check box

**Rev.** (Reverse) lets you play the selected Multisample backwards, without looping. This can produce interesting results for sound effects or other unusual timbres. Reverse applies only to Multisamples; when the **Type** is set Wave Sequence, this is grayed out.

**Note:** this does not apply to samples from EXs or User Sample Banks whose Load Method is set to Virtual Memory.

MS	Multisample/Wave Sequence	Start Offset	Rev.	Level	Bottom Vel.	Xfade Range	Curve
1	Multi ROM s 00002:Acoustic Piano 1 ff	> Off	<input type="checkbox"/>	108	080	020	> Linear
2	Multi ROM s 00001:Acoustic Piano 1 f	> Off	<input type="checkbox"/>	110	001	Off	> Linear
3	Off ROM s 00000:Acoustic Piano 1 mf	> Off	<input type="checkbox"/>	127	001	Off	> Linear
4	Off EXs1 s 00000:Acoustic Piano 1 mp	> Off	<input type="checkbox"/>	120	001	Off	> Linear

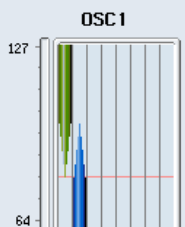

## Using LFOs and Envelopes (EGs)

### Using LFOs

Each Oscillator has two LFOs: LFO1 and LFO2. There is also a single Common LFO, shared by both Oscillators. While LFO1 and LFO2 are separate for each voice, the Common LFO is shared by all voices in the Program. This makes it useful when you want all of the voices to have an identical LFO effect.

You can use these LFOs to modulate many different Program parameters, including:

- Pitch (for vibrato)
- Filters (for wah effects)
- Volume (for tremolo)
- Pan (for auto-panning)

The LFOs can modulate many other parameters, in addition to those listed above.

### Basic LFO programming

The KRONOS LFOs are very powerful, and offer lots of control for the power user. It's simple to get started with them, though—and the graphics on the LCD show how the parameters affect the sound. Let's take a brief tour.

1. Go to the OSC1 LFO1 tab of the LFO page.
2. Select the Waveform parameter.
3. Use the Inc  $\wedge$  or Dec  $\vee$  buttons to scroll through the different waveforms, and look at their shapes in the graphic display.

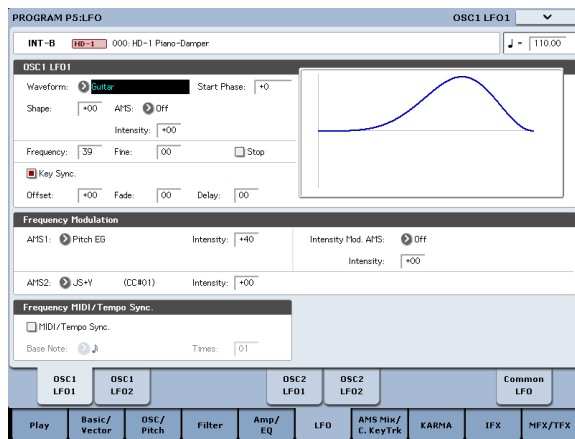

There are a number of waveforms to choose from. Each are suited to different applications:

- **Triangle** and **Sine** are the classic LFO shapes for vibrato, tremolo, panning, and filter wah effects.
  - **Square** is useful for gated filter and amp effects, and creates a police siren effect when modulating pitch.
  - The **Guitar** waveform is designed especially for guitar vibrato, since it bends only upwards from the base value.
  - **Saw** and **Exponential Saw Down** are good for rhythmic filter and amp effects.
  - **Random 1 (S/H)** creates the classic sample-and-hold effect, which is great for modulating a resonant filter.
4. After looking at the different waveforms, select **Triangle**.

5. Select the **Shape** parameter, and use the **VALUE** slider to move through its different settings, from **-99** to **+99**.

Notice how the shape of the waveform becomes more curved, and how **-99** emphasizes the lower part of the shape, and **+99** emphasizes the upper part.

6. Select the **Start Phase** parameter, and use the **VALUE** slider to sweep through its range of values.

Notice how the waveform shifts from side to side. Among other things, this lets you offset the LFOs from one another in time, which can create interesting organic effects.

7. Use the **Frequency** parameter to set the speed of the LFO.

8. Use the **Fade** and **Delay** settings to control the way the LFO sounds at the beginning of the note.

For more information on LFOs, see “Program P5: LFO” on page 91 of the Parameter Guide.

All of these parameters control the way that the LFO itself works. In order for the LFO to actually affect the sound, you can use the dedicated LFO routings on the Filter, Pitch, and Amp pages, or use the LFOs as AMS sources for a wide variety of parameters.

### Frequency Modulation

AMS can be used to vary the LFO speed. This lets you change the LFO speed by operating a controller, or by the EG or Keyboard Track settings.

### MIDI/Tempo Sync.

If **MIDI/Tempo Sync** is checked, the **Frequency** setting will be ignored, and the LFO will synchronize to the system tempo, as set by the TEMPO knob or external MIDI clocks.

This lets you produce vibrato, wah, auto-pan, or tremolo effects that lock to the Drum Track, KARMA, Wave Sequences, the internal sequencer, or external MIDI sequencers.

### EGs (Envelope Generators)

An envelope creates a modulation signal by moving from one level to another over a specified time, and then moving to another level over another period of time, and so on.

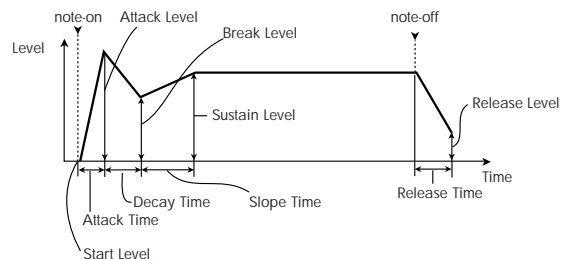

The HD-1 includes three EGs, for Pitch, Filter, and Amp. These produce time-varying changes in pitch, tone, and volume respectively. They can also be used to modulate a number of other Program parameters via AMS.

## Using Alternate Modulation (AMS) and the AMS Mixers

**AMS (Alternate Modulation Source)** refers to any of the assignable modulation sources in KRONOS, including:

- Built-in physical controllers, such as the Joystick, Ribbon, and Real-Time Knobs
- Incoming MIDI controllers, or MIDI controllers generated by KARMA or the Vector EG
- Modulators such as the Filter, Pitch, and Amp EGs, the LFOs, or the AMS Mixers

**Intensity** is a parameter that sets the degree (speed, depth, amount etc.) to which AMS will control the modulation.

A number of frequently-used modulation routings, such as using the joystick to vary the pitch, are provided as additional, dedicated routings, separate from AMS.

Note that not all AMS sources may be available for some modulation destinations.

For details on alternate modulation and AMS, see “Alternate Modulation Sources (AMS),” on page 1095 of the Parameter Guide.

### Using the AMS Mixers

The AMS Mixers combine two AMS sources into one, or process an AMS source to make it into something new.

For instance, they can add two AMS sources together, or use one AMS source to scale the amount of another. You can also use them to change the shapes of LFOs and EGs in various ways, modify the response of realtime controllers, and more.

The AMS Mixer outputs appear in the list of AMS sources, just like the LFOs and EGs.

This also means that the original, unmodified inputs to the AMS Mixers are still available as well. For instance, if you use LFO 1 as an input to a AMS Mixer, you can use the processed version of the LFO to control one AMS destination, and the original version to control another.

Finally, you can cascade the two AMS Mixers together, by using AMS Mixer 1 as an input to AMS Mixer 2.

### Adding two AMS sources together

AMS mixers will do different things depending on their **Type** setting. The **A+B** setting merges two AMS sources into one. This can be handy when you need to add one more modulation source to a parameter, but you’ve already used up all of the available AMS slots.

For instance, let’s say that you’re using an LFO to modulate Filter Resonance, and then you decide that it would be interesting to scale that parameter with an EG as well. Resonance has only a single AMS input, but you can easily merge the LFO and the EG together using the A+B AMS Mixer:

1. Assign the LFO to AMS A.
2. Assign the EG to AMS B.
3. Assign the AMS Mixer as the Filter Resonance AMS source.

#### AMS Mixer A+B example

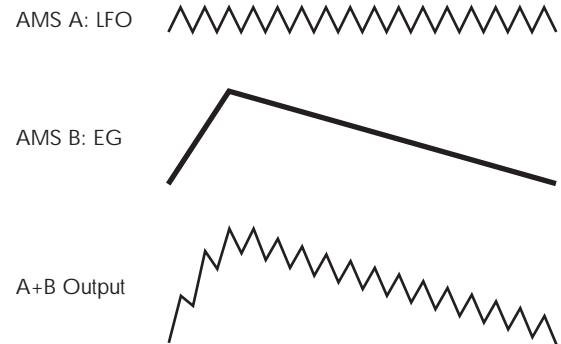

#### Scaling one AMS source with another

When the **Type** is set to **Amt A x B**, the mixer uses the AMS B input to scale the amount of AMS A. For instance, you can control the amount LFO1 with the Filter EG, or control the amount of the Pitch EG with the ribbon.

#### AMS Mixer Amt AxB example

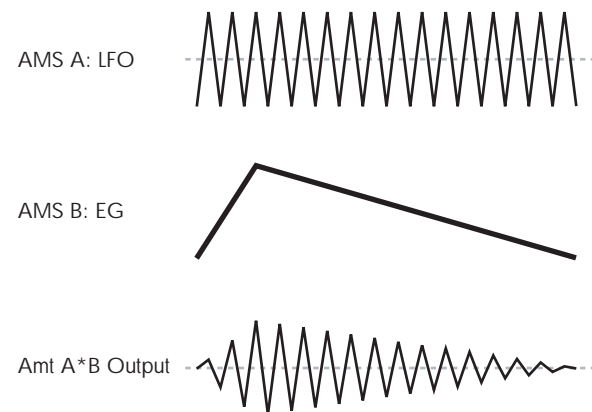

#### Smoothing

The **Smoothing Type** smooths out the AMS input, creating more gentle transitions between values. You have separate control of the amount of smoothing during the attack (when the signal is increasing) and decay (when it’s decreasing).

Low settings provide subtle controller smoothing, creating more gradual aftertouch, for instance. Higher settings create auto-fade effects, transforming a quick gesture into a longer fade-in and/or fade-out event.

Smoothing can also be used to alter the shape of programmable mod sources, such as LFOs and EGs. For instance, you can turn a “blip” into a simple envelope shape, as shown below.

### AMS Mixer Smoothing examples

Original AMS A:                      Smoothing with Long Attack and Short Release:



Smoothing with Short Attack & Long Release:



### More AMS Mixer features

There are more mixer **Types**, including **Offset**, **Shape**, and **Quantize**, which offer even more possibilities for creative programming. For more details, see these sections in the Parameter Guide:

- “6–1: OSC 1 AMS Mixer” on page 97
- “Using SW 1/2 to turn an AMS source on and off” on page 98
- “Muting individual Wave Sequence steps with SW1” on page 99
- “Converting from bipolar to unipolar” on page 99
- “Converting from unipolar to bipolar” on page 99

- “Quantized Ribbon Pitch Bend” on page 101
- “Selective pitch-bend, using a switch” on page 102
- “Selective pitch-bend, using only the joystick” on page 102
- “Generating a static value” on page 103

## Suggestions on using AMS

When making settings for alternate modulation, think of the effect that you wish to produce, what type of modulation will be necessary to produce that effect, and what parameter of the oscillator, filter, or amplifier needs to be controlled.

Next, select a source (**AMS**) and set the **Intensity**. If you proceed logically in this way, you will achieve the desired effect.

For example, if you want to control a guitar sound so that it approaches feedback when you move the joystick, you might set up the joystick to modulate the filter frequency and resonance.

## Controller Setup page

For each program, this tab lets you make settings for the SW1 and SW2 key, and for Real-Time Knobs 5-8. For more information, see “SW1 and SW2” on page 35, and “1–8: Set Up Controllers,” on page 53 of the Parameter Guide.

## Controlling Pitch

Parameters for controlling pitch are located on the P2:OSC/Pitch page, as shown below.

P2: OSC/Pitch page

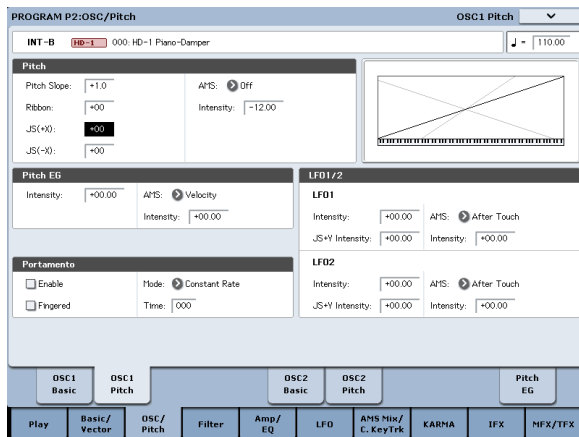

### Pitch bend

The **JS (+X)** and **JS(-X)** settings specify the amount of pitch change (in semitones) that will occur when MIDI pitch bend messages are received or when the joystick is moved to left or right. A setting of **+12** allows the pitch to be controlled a maximum of one octave upward; a setting of **-12** allows the pitch to be controlled a maximum of one octave downward.

**Ribbon** specifies the amount of pitch change (in semitones) that will occur when MIDI control change (CC) #16 messages are received, or when you move your finger left and right on the ribbon controller. With a setting of **+12**, the

pitch will be raised one octave at the far right of the ribbon controller, and will be lowered by one octave at the far left of the ribbon controller.

### Creating Vibrato

You can use an LFO to create vibrato.

**LFO 1/2 Intensity** sets the depth to which the selected LFO will affect the pitch. With a setting of **+12.00**, vibrato will produce a maximum of  $\pm 1$  octave of pitch change.

**JS+Y Int** specifies the amount of vibrato that the LFO will produce when the joystick is pushed away from yourself.

**Intensity** (AMS Intensity) specifies the depth of vibrato that will be applied by the LFO when modulated by the selected AMS (Alternate Modulation Source). For example, if **LFO1 AMS** is set to After Touch and you set an appropriate value for **Intensity**, vibrato will be applied when you apply pressure to the keyboard or when MIDI aftertouch messages are received.

### Pitch EG

When the **Intensity** value is set to **+12.00**, the pitch EG specified in the Pitch EG page will produce a maximum of  $\pm 1$  octave of pitch change.

To realistically simulate the slight change in pitch that occurs when a string is plucked or at the attack of a brass or vocal sound, you can use the EG to create a subtle change in pitch at the attack.

### Portamento

Portamento makes the pitch change smoothly when you play the next note before releasing the previous note.

The **Time** parameter controls how long it takes the pitch to change. As this value is increased, the pitch will change over a longer time. With a value of **000**, there will be no portamento.

You can turn Portamento on and off via SW1 or SW2, by assigning them to **Porta.SW CC#65**.

## Using Filters

The filters allow you to diminish or emphasize specified frequency areas of the sound.

The tone of the sound will depend significantly on the filter settings.

The basic filter settings, including the routing, type, cutoff frequency, and resonance, are set on the P3: Filter page.

### Filter Routing

Each oscillator has two filters, Filter A and Filter B. The **Routing** parameter controls whether one or both of the filters are used, and if both are used, it controls how they are connected to each other.

The **Single** routing uses only Filter A as a single 2-pole, 12dB/octave filter (6dB for Band Pass and Band Reject).

The **Serial** routing uses both Filter A and Filter B. The oscillator first goes through Filter A, and then the output of Filter A is processed through Filter B.

**Parallel** also uses both Filter A and Filter B. The oscillator feeds both filters directly, and the outputs of the two filters are then summed together.

The **24dB/4-pole** routing merges both filters to create a single 4-pole, 24dB/octave filter (12dB for Band Pass and Band Reject). In comparison to Single, this option produces a sharper roll-off beyond the cutoff frequency, as well as a slightly more delicate resonance. Many classic analog synths used this general type of filter.

#### Serial and Parallel Routing

##### Serial

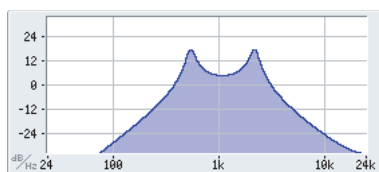

##### Parallel

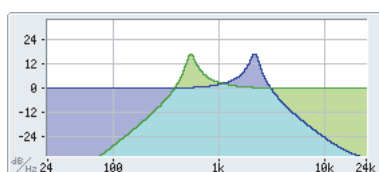
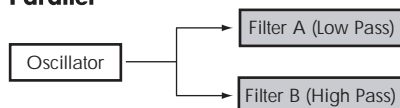

### Filter Types

This selects the parts of the sound which will be affected by the filter, as described below. With the Serial and Parallel routings, you can independently set the types for Filter A and Filter B.

The filters will produce very different results depending on the selected filter type. The selections will change slightly according to the selected **Filter Routing**, to show the correct cutoff slope in dB per octave.

**Low Pass.** This cuts out the parts of the sound which are **higher** than the cutoff frequency. Low Pass is the most common type of filter, and is used to make bright timbres sound darker.

**High Pass.** This cuts out the parts of the sound which are **lower** than the cutoff frequency. You can use this to make timbres sound thinner or more buzzy.

**Band Pass.** This cuts out all parts of the sound, both highs and lows, except for the region around the cutoff frequency. Since this filter cuts out both high and low frequencies, its effect can change dramatically depending on the cutoff setting and the oscillator's multisample.

With low resonance settings, you can use the Band Pass filter to create telephone or vintage phonograph sounds. With higher resonance settings, it can create buzzy or nasal timbres.

**Band Reject.** This filter type—also called a notch filter—cuts only the parts of the sound directly around the cutoff frequency. Try modulating the cutoff with an LFO to create phaser-like effects.

Filter Types and Cutoff Frequency

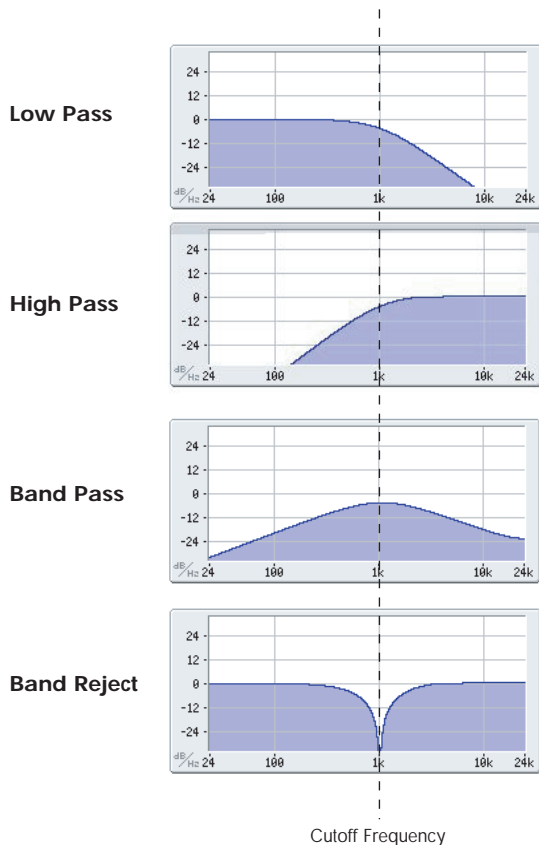

Resonance

Resonance emphasizes the frequencies around the cutoff frequency, as shown in the diagram below.

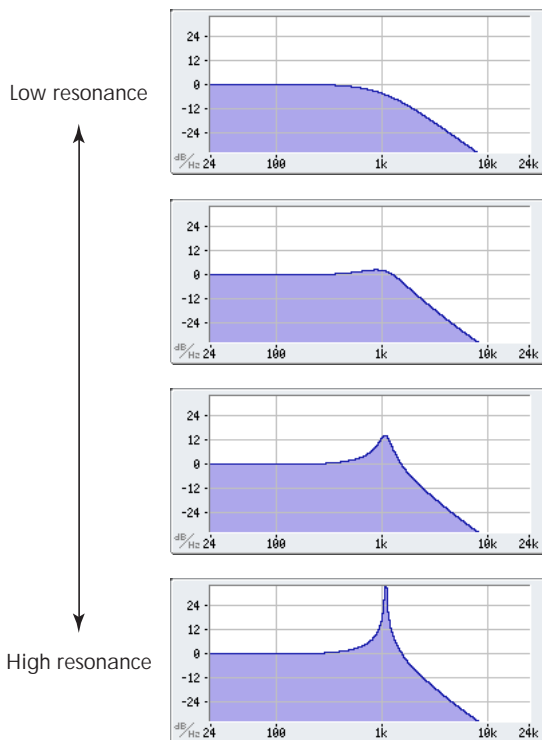

When this is set to 0, there is no emphasis, and frequencies beyond the cutoff will simply diminish smoothly.

At medium settings, the resonance will alter the timbre of the filter, making it sound more nasal, or more extreme. At very high settings, the resonance can be heard as a separate, whistling pitch.

To make the resonance track the keyboard pitch, see “Key Follow,” on page 73 of the Parameter Guide.

Modulating the filters

You can modulate the filter cutoff frequency using the Filter EG, the LFOs, keyboard tracking, and other built-in and MIDI controllers. This is a great way to add a rich variety of tonal change to the sound.

Filter EG

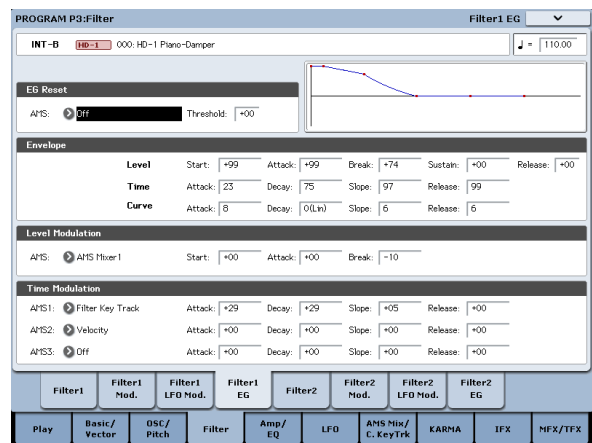

The Filter EG is a multi-stage envelope, which you can use to modulate the filter (naturally!) as well as other Program parameters. The EG itself is set up on the Filter EG tab; the way that it affects the filters is controlled by the parameters described below, on the Filter Mod tab:

The **Intensity to A** and **Intensity to B** settings control the basic amount of EG modulation for filter frequencies A and B, respectively, before other modulation.

The **Velocity to A** and **Velocity to B** settings let you use velocity to scale the amount of EG modulation.

The **AMS** setting selects a AMS modulation source to scale the amount of the Filter EG applied to Filters A and B. The two filters share a single AMS source, with separate intensity settings.

LFO modulation

You can modulate the filter via LFO1, LFO2, and the Common LFO. Among other applications, LFO modulation of the filter can produce the classic “auto-wah” effect.

The Filter LFO Mod tab lets you set up the following parameters separately for each LFO:

**Intensity to A** and **Intensity to B** specify how much the LFO changes the tone.

**JS-Y Intensity to A** and **JS-Y Intensity to B** specify the depth of the wah effect produced by the LFO when the joystick is moved toward yourself, or when CC#2 is received.

The **AMS** setting selects a AMS modulation source to scale the amount of the LFO applied to Filters A and B. The two filters share a single AMS source, with separate intensity settings.



For example if, **AMS** is set to **After Touch**, applying pressure to the keyboard produces an “auto-wah” effect.

### Keyboard Track

Most acoustic instruments get brighter as you play higher pitches. At its most basic, keyboard tracking re-creates this effect by increasing the cutoff frequency of a lowpass filter as you play higher on the keyboard. Usually, some amount of key tracking is necessary in order to make the timbre consistent across the entire range.

The KRONOS keyboard tracking can also be much more complex, since it allows you to create different rates of change over up to four different parts of the keyboard. For instance, you can:

- Make the filter cutoff increase very quickly over the middle of the keyboard, and then open more slowly—or not at all—in the higher octaves.
- Make the cutoff increase as you play *lower* on the keyboard.
- Create abrupt changes at certain keys, for split-like effects.

### How Key Track works: Keys and Ramps

The keyboard tracking works by creating four ramps, or slopes, between five keys on the keyboard. The bottom and top keys are fixed at the bottom and top of the MIDI range, respectively. You can set the other three keys—named Low Break, Center, and High Break—to be anywhere in between.

The four Ramp values control the rate of change between each pair of keys. For instance, if the Low-Center Ramp is set to 0, the value will stay the same between the Low Break key and the Center key.

You can think of the resulting shape as being like two folding doors attached to a hinge in the center. At the Center key (the main hinge), the keyboard tracking has no effect. The two folding doors swing out from this center point to create changes in the higher and lower ranges of the keyboard.

**Intensity to A** and **Intensity to B** adjust the effect that keyboard tracking will have on filters A and B. For more information, see “3–2a: Keyboard Track,” on page 71 of the Parameter Guide.

### AMS Modulation

In addition to the EG, LFOs, and Key Track, you can use two AMS sources to modulate the filters. For instance, you could use the ribbon to change the brightness, or use the AMS output of a Wave Sequence.

### Keyboard Track Shape and Intensity

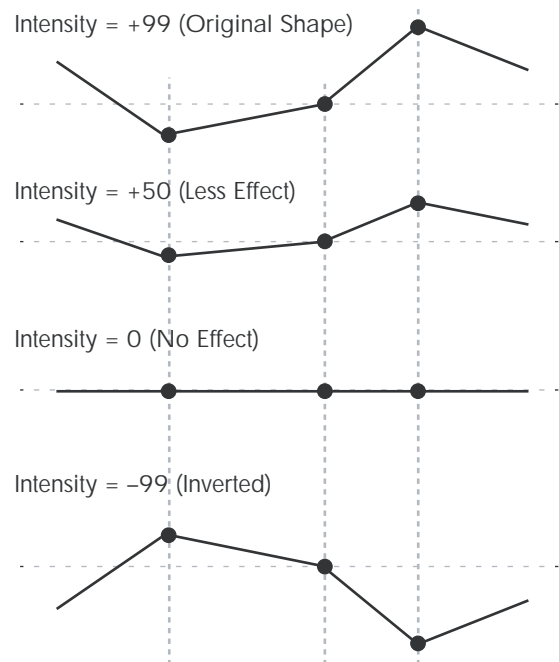

## Using the Amp section

The Amp section includes controls for volume, pan, and the driver circuit. You can control the volume using the Amp EG, LFO 1/2, Key Track, and velocity, along with other AMS sources.

Each Oscillator has its own Amp section: Amp1 for OSC1, and Amp2 for OSC2.

### Background: what does “Amp” mean?

Different sounds have characteristic shapes to their volume levels.

For example, the volume of a piano note begins at a high volume the instant you play the note, and then decreases gradually.

The volume of an organ note, on the other hand, remains constant as long as you continue pressing the key.

The volume of a note on a violin or wind instrument can be varied during the note by the musician (i.e., by regulating the amount of pressure on the bow or the force of the breath).

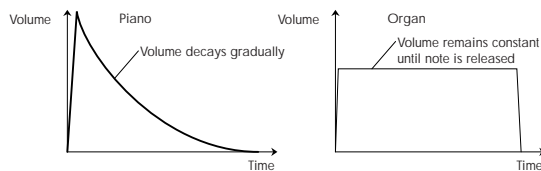

## Pan

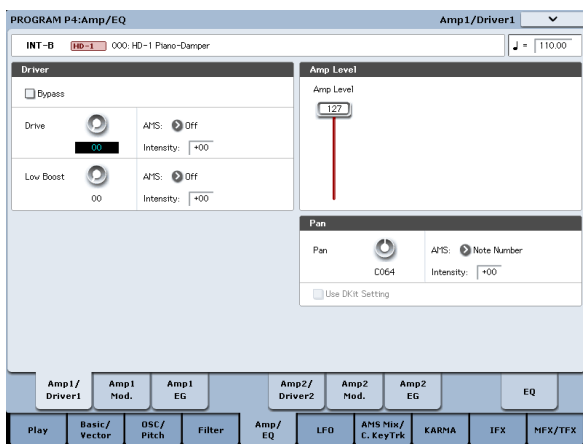

## Pan

The main **Pan** parameter controls the stereo position after the signal has passed through the oscillator, filter, and amp. Normally you'll set this to **C064**, so that the sound is centered equally between the left and right speakers.

To create a stereo effect when **Oscillator Mode** is set to **Double**, set the Amp1/Driver 1 page **Pan** to L001, and the Amp2/Driver2 page **Pan** R127. This will make OSC1 go to the left speaker, and OSC2 go to the right speaker.

With a setting of **Random**, the pan will change randomly each time you play a note on KRONOS, producing an interesting effect.

## Pan AMS and Intensity

**Intensity** specifies the depth of the pan modulation from the selected AMS source.

If you set **AMS** to **Note Number**, the pan will change according to the keyboard position of each note played. With a setting of **LFO1** or **2**, the sound will sweep from side to side, creating an auto-pan effect. Other settings allow you to move the oscillator pan by using a real-time controller, an envelope, or other modulation sources.

## Pan - Use DKit Setting

**Use DKit Setting** applies when **Oscillator Mode** is set to **Drums**. If this is **checked**, the Program can use a different pan position for each drum sound, as specified by the Drum Kit. If this is **unchecked**, all drum sounds will use the Program's pan position. The factory presets and GM drum kits use individual pan positions for the different drums, so normally it's best to leave this checked.

## Amp modulation

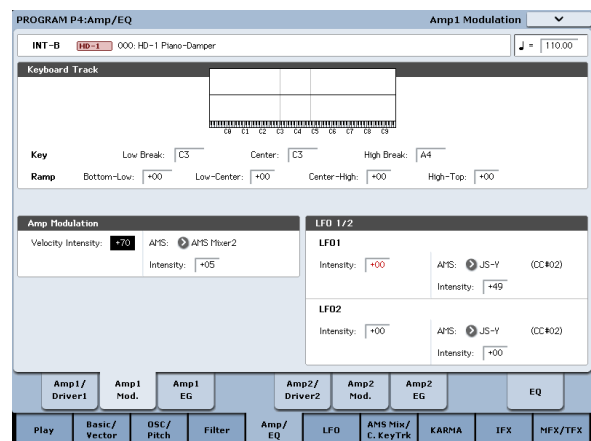

The basic volume level is set by the **Amp Level** parameter. You can then alter this using the modulation sources below:

### Keyboard Track

This lets you vary the volume relative to the note you play. For more information, see “Keyboard Track” on page 55.

### Amp Modulation

**Velocity Intensity** is used by most programs to decrease the volume of softly played notes and increase the volume of strongly played notes, and the Amp Modulation parameter adjusts the depth of this control. Normally you will set Amp Modulation to positive (+) values. As this setting is increased, there will be greater volume difference between softly played and strongly played notes.

### LFO1/2

Specifies how the LFOs will produce cyclic changes in volume (tremolo effect).

The volume will be affected by the LFO(s) for which you set an **LFO1 Intensity**, **LFO2 Intensity** value.

**Intensity** (AMS Intensity) adjusts the depth by which the tremolo effect produced by the LFO will be affected when you assign an **AMS** (LFO1 AMS, LFO2 AMS).



For example if you set **AMS** to **JS-Y (CC #02)**, tremolo will be applied when you move the joystick of KRONOS toward yourself, or when CC#02 is received.

---

## Amp EG

The Amp EG lets you control how the volume changes over the course of a note.

Every instrument has its own characteristic volume envelope. This is part of what gives each instrument its identifiable character.

Conversely, by changing the volume contour—for instance, applying a string-like Amp EG curve to an organ multisample—you can produce interesting and unusual sounds.

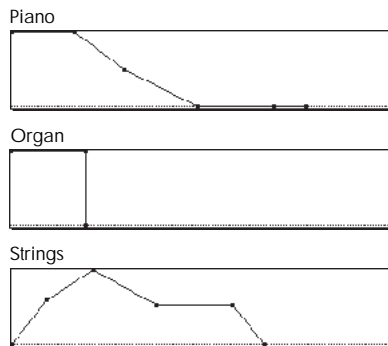

---

## Drive

The Drive circuit adds saturation and overdrive to the sound, for everything from subtle fattening to drastic distortion. Unlike an overdrive effect, Drive processes each voice individually, so the timbre stays the same regardless of how many voices are being played.

The two main parameters, Drive and Low Boost, work together to create the overall effect.

**Drive** controls the amount of edge and bite in the timbre. Low settings will produce mild saturation, and higher settings create more obvious distortion.

Often, it's useful to increase the **Low Boost** along with the **Drive**.

Note: even when the **Drive** amount is set to 0, the **Drive** circuit still affects the timbre. If your goal is a completely pristine sound, use the **Bypass** control instead.

**Low Boost** is a special low-frequency EQ which controls the body character of the sound. The specific EQ frequencies affected will change with the Drive setting.

Higher amounts increase the bass boost, and will also intensify the effect of the Drive parameter.

## Using EXi

In EXi Programs, you can select one or two EXi to be split or layered together. Each EXi has its own sonic character and different pages of parameters.

To select different EXi:

### 1. Select an EXi Program.

Note: EXi Programs are stored in EXi Banks, separate from HD-1 Programs. Depending on settings, any bank except for INT-G may be an EXi bank.

### 2. Press the Common button.

### 3. Press the Basic/Vector tab.

The P4: Basic/Vector Program Basic page appears.

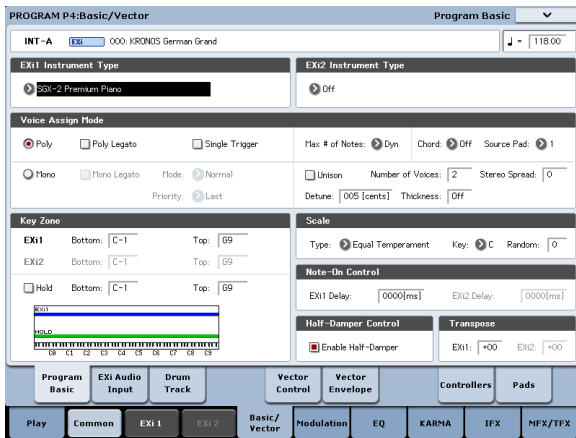

### 4. Under EXi 1 Instrument Type, at the top left of the display, select any of the EXi.

You can also select a second EXi under EXi 2 Instrument Type, but for now let's concentrate on EXi 1.

### 5. Press the EXi 1 button at the bottom of the display.

The tabs will change to show the pages for the selected EXi. Time to explore!

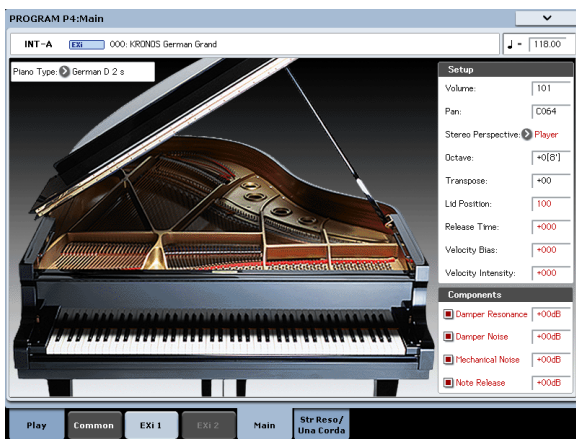

## SGX-2 Premium Piano

### Redefining the workstation piano

You've never heard a piano like this on a workstation. Every note is sampled in stereo at up to 12 velocity levels with no loops, for smooth response and natural decays—plus multiple velocity layers of true damper resonance, along with modeled string resonance. Additionally, some sounds include dedicated Una Corda samples.

The SGX-2 also provides the exceptionally high polyphony that real acoustic piano sounds require—up to 100 dual-stereo notes, the equivalent of 400 mono voices.

### String Resonance

When a note is played on a piano, any other un-damped strings will resonate slightly, with an intensity corresponding to their harmonic relationship to the played note. An extreme example of this is heard when the damper pedal is down, at which point all of the strings resonate together. However, it also happens whenever a note is played while one or more other harmonically related notes are held—even when the damper pedal is off. For instance, if you hold C2 and then sharply play and release C3, you'll hear a faint echo of the C3 ringing from the C2 string.

The SGX-2's modeled string resonance can be turned on and off for each individual Program. With older Programs, it will be turned off by default. To turn it on, go to the P5-1: String Resonance/Una Corda page, enable the String Resonance check-box, and set the Depth as desired. For more information, see "5-1a: String Resonance" on page 396 of the Parameter Guide.

### Una Corda

Most KRONOS sounds, including all SGX-2 Piano Types, include at least basic support for soft pedals via MIDI CC#67. For these sounds, when CC#67 is on, effective velocity is reduced—as if you were playing a little softer than you actually are.

As an alternative to this approach, some SGX-2 Piano Types include dedicated Una Corda samples. With these Piano Types, CC#67 switches to a different, dedicated set of samples instead of modifying velocity.

The P5: Resonance/Una Corda page includes a graphic dedicated to Una Corda. If the selected Piano Type includes Una Corda samples, the graphic in this section of the display will be active. If it does not include Una Corda samples, the graphic will be grayed out.

For more information, see "5-1b: Una Corda" on page 396 of the Parameter Guide.

## EP-1 MDS Electric Piano

### New technology, classic sounds

The EP-1 provides incredible recreations of six classic tine and reed electric pianos, along with modeled vintage effects. Based on Korg's Multi-Dimensional Synthesis (MDS), the EP-1 delivers natural real-time expression without the limitations of ordinary sample playback. For instance, you'll appreciate the natural decay and astonishingly smooth gradation of dynamics from pp to ff, without tell-tale split points - just like the real instruments.

Real-time control over noise elements, including mechanical key-off noises controlled by release velocity, gives your performances even greater realism and detail.

---

## CX-3 Tonewheel Organ

### Modeled organ with drawbar control

Based on Korg's ground-breaking CX-3 keyboard (with additional refinements), the CX-3 is a detailed tone-wheel organ model with live drawbar control,

Perfect tone-wheel phase coherency means solid, powerful sounding chords just like the real thing. A choice of tone wheel types, adjustable overtones, leakage, noise, and key-click modeling provide unparalleled realism.

Amp modeling, Vibrato/Chorus, and Rotary Speaker effects are built in. EX mode lets you introduce additional drawbar and percussion harmonics, for new timbres unavailable on traditional organs.

---

## AL-1 Analog Modeling Synthesizer

### Modern virtual analog synth

The AL-1 is our feature-packed, modern virtual analog synth. Its patented ultra-low-aliasing oscillators (using completely different technology than the HD-1) recreate all the power and glory of true analog synthesis—without the artifacts that can plague lesser instruments.

Morphing waveforms allow you to change the oscillator shapes in real-time. Resonance modeling lets you choose between classic filter sounds, and the extraordinarily flexible MultiFilter lets you create your own hybrid filter shapes. Hard sync, analog-style FM, drive, low-boost, and ring modulation offer plenty of tone-twisting power.

---

## MS-20EX

### Patch-panel synth with unique, aggressive tone

A dramatic expansion of Korg's classic MS-20 analog synth, the MS-20EX puts modular patch cables under your fingertips. Modulate filters with audio-rate oscillators; turn audio inputs into control signals; control all of the original knobs with mod sources including additional envelopes, LFOs, and real-time controllers.

It's a tweaker's dream, but even without the patch panel, the MS-20EX would make waves with its unique, aggressive tone—due in large part to its unusual filters, which are completely different from those in either the AL-1 or the PolysixEX.

---

## PolysixEX

### Rich-sounding, versatile, and easy-to-use synth

With its self-oscillating four-pole filter, smooth analog oscillator and sub-oscillator, and rich, built-in chorus and ensemble effects, the PolysixEX proves you don't have to be fancy in order to be great.

Based on the classic Korg Polysix analog synth, its timbre is distinctly different from the AL-1 and the MS-20EX, but we didn't stop there; we added modulation of every control on the front panel, for a world of sounds impossible on the original.

It's also very well-suited to hands-on control with Tone Adjust, with a knob, slider, or switch for almost all of the original Polysix controls. As a bonus, it's also capable of extremely high polyphony—up to 180 voices!

---

## STR-1 Plucked String

### Physical modeling, from the real to the fantastic

Physics has brought us lasers, cell phones, electric cars—and now the STR-1. What would it sound like to play harmonics on a metal bar “plucked” by a piano, or to sing into a guitar string? Play with the STR-1 and discover.

In addition to unique, experimental timbres, the STR-1 is great for traditional instruments from guitars, basses, harps, and world/ethnic sounds to clavichords, harpsichords, bells, and electric pianos.

You can also process samples and live audio input through the physical model—including audio feedback from any of the KRONOS effects.

---

## MOD-7 Waveshaping VPM Synthesizer

### Patch-panel VPM/waveshaping/PCM processor

Combine Variable Phase Modulation (VPM), waveshaping, ring modulation, samples, and subtractive synthesis with a modular patch-panel system, and you have the MOD-7. Exceptionally versatile, it offers everything from classic FM keyboards, bells and basses (including the ability to import sounds from vintage DX synths) to rhythmic soundscapes and sparkling, epic pads.

Vast sample-mangling capabilities, with incredible flexibility and power, let you create incredibly rich processing environments: combine multiple stages of filtering, waveshaping, and ring modulation, even use samples as FM modulators, all patched together however you like.

## Using Vector Synthesis

Vector Synthesis lets you control Program and Effects parameters by moving the Vector Joystick, by using the programmable Vector Envelope, or by the combination of the two.

### What does Vector mean?

Modulation generally works by moving a single control, like a slider, in a straight line. At one end of the control, the modulation is at its minimum; at the other end, it's at its maximum.

Vector Synthesis is a little different. It works by moving around a point on a two-dimensional plane, both left-right and up-down.

You can think of this point as being positioned on two different lines at once: a left-right line (the X axis), and an up-down line (the Y axis).

In other words, instead of just having one value (like a slider), each Vector point has two values: one for X, and one for Y. See the graphic below for an example.

*Vector Point and X and Y axis values*

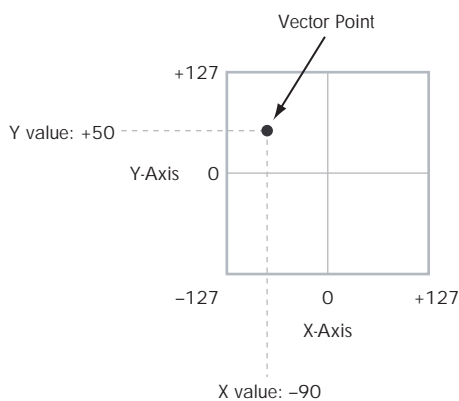

In addition to moving the point directly with the Vector Joystick, you can also use the Vector Envelope to move its position automatically over time, as shown below.

*Vector Envelope moving the Vector Point*

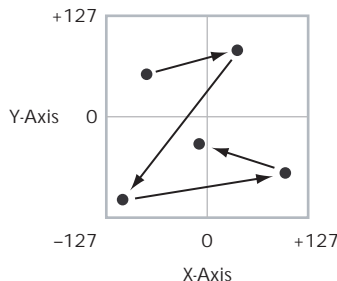

### Vector Joystick and Vector Envelope

You can move the Vector point using the combination of the Vector Joystick and the Vector Envelope. The two work together, although you don't necessarily have to use them both at the same time.

When the Vector Joystick is in its center position, the Vector Envelope has complete control over the point's position. Likewise, when the Vector Envelope is in the center, the Vector Joystick has complete control.

When the Vector Envelope is in use, the Vector Joystick offsets the position by up to halfway across either axis. For instance, if the Envelope is all the way to the right of the X axis, and the Joystick is all the way to the left, the actual Vector position will be in the center of the X axis.

*Hint:* to quickly reset the Vector Joystick to its center value, hold down the front-panel **Control Reset** button and move the joystick.

### Vector Volume Control and CC Control

The Vector does two main things: it can control the relative volume of the two Oscillators in Program mode (or of up to 16 Programs at once in Combi mode), and it can generate CCs for controlling Program and Effects parameters.

### Vector and MIDI

The Vector features interact with MIDI in two different ways: through the Vector Joystick, and through the Vector CC Control.

The **Vector Joystick** sends and receives two MIDI controllers: one for the X axis, and the other for the Y axis. In Global mode, you can assign these to any MIDI CC numbers you like. The defaults are CC#118 for the X axis, and CC#119 for the Y axis.

The Vector Joystick and its CCs *control* the Vector position, in conjunction with the Vector EG.

The **Vector CC Control**, on the other hand, is *generated by* the Vector position. Normally, this will only affect internal sounds and effects. If you like, however, you can also enable a Global parameter to send these generated CCs to external MIDI devices.

For more information on Vector Synthesis, see "1-5: Vector Control" on page 46 of the Parameter Guide.

Vector Synthesis System

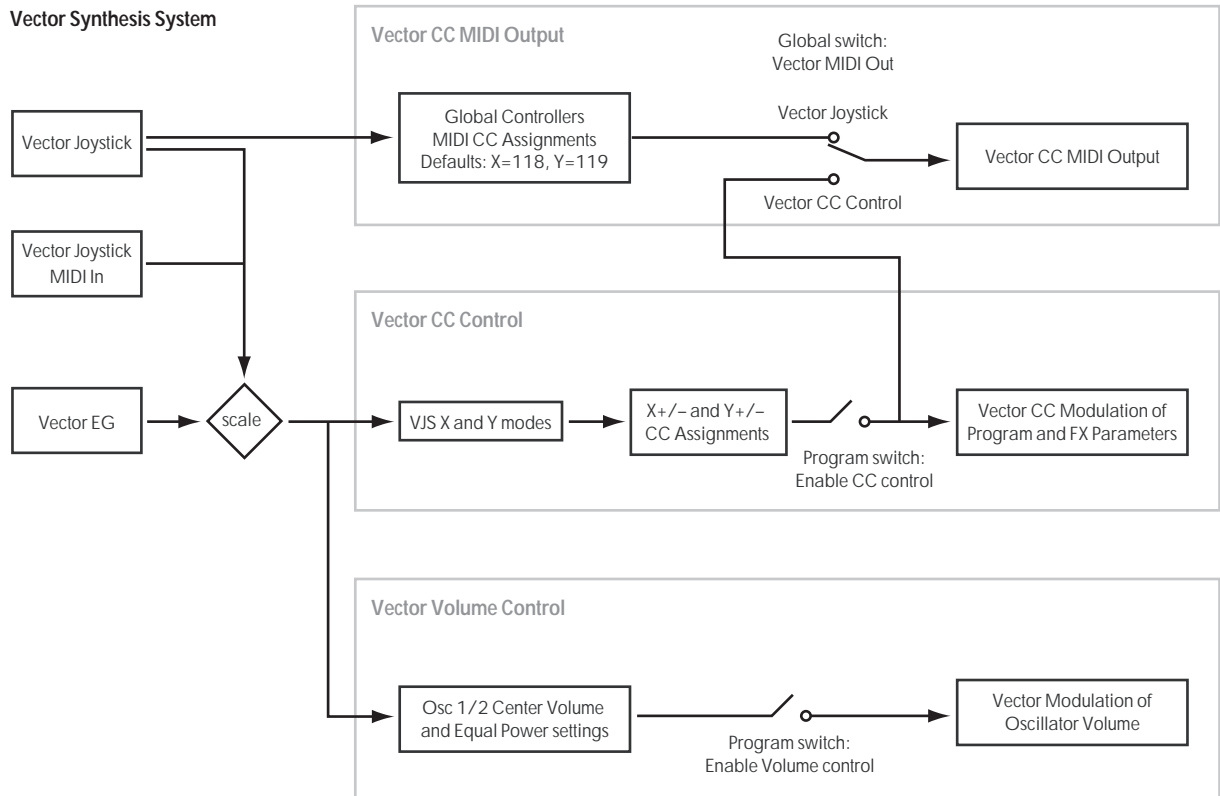

### Effects

Effects are covered in their own section of the manuals, so we won't go into too much detail here. See the cross-references below for more information.

---

#### Insert Effects

Insert Effects let you send either individual Oscillators or the entire Program through up to 12 effects, in series. You can use any type of effects, from distortions and compressors to choruses and reverbs. The Insert Effects can be routed to the main outputs, or to any of the individual outputs.

For more information, see "Insert effects" on page 214.

---

#### Master Effects

There are two Master Effects, which are accessed through Sends 1 and 2. These are best-suited to effects such as reverbs and delays, but you can use them with any type of effect.

For more information, see "Master effects" on page 215.

---

#### Total Effects

The two Total Effects are dedicated to processing the main L/R outputs. They're ideally suited to overall mix effects, such as compression, limiting, and EQ—but as with the other effects sections, you can use any type of effect that you like.

For more information, see "Program P9: Master/Total Effect" on page 144 of the Parameter Guide.

---

## Automatically importing a Program into Sequencer mode

The Auto Song Setup feature copies the current Program or Combination into a Song, and then puts the KRONOS in record-ready mode.

If inspiration for a phrase or song strikes you while you're playing, you can use this function to start recording immediately. To do so:

1. **Hold down the ENTER key and press the SEQUENCER REC/WRITE key.**

The Setup to Record dialog box will open and ask "Are you sure?"

2. **Press OK.**

You will automatically enter Sequencer mode, and will be in the record-ready state.

3. **Press the START/STOP key to start the sequencer and begin recording.**

# Playing and editing Combinations

## Playing Combinations

### What's a Combination?

Combinations, or “Combis” for short, let you split and layer up to 16 Programs at once.

A Combi is made up of 16 Timbres. Each Timbre has a Program, along with parameters for key and velocity zones, mixer settings, MIDI channel and controller filtering, and so on.

As with Programs, each Combi has 12 Insert Effects, 2 Master Effects, and 2 Total Effects, for shaping and transforming the sounds of the individual Timbres. Finally, Combis can use 4 KARMA modules at once, for complex and layered generated effects.

## Selecting Combinations

There are several different ways to select Combinations. Each one is convenient in a different way:

- Using the front-panel buttons, value slider, and value knob, you can select Combinations quickly via physical controls
- Selecting by Bank and number (via the touch-screen) lets you browse through all of the Combinations in memory, to find the one that you want
- Selecting by Combination category (via the touch-screen) lets you filter Combinations by sound type, such as Pianos or Drums
- Using Find (via the on-screen magnifying-glass icon) lets you search for Combinations by name
- Using a foot-switch lets you change Combinations even while both hands are busy playing on the keyboard - convenient for live applications
- MIDI program change messages let you select Combinations remotely, from either -a MIDI sequencer or an external MIDI controller

### Set Lists

Combinations can also be selected in Set Lists, along with Programs and Songs. For more information, see “Set Lists” on page 119.

## Overview: Combination Banks

KRONOS ships from the factory with hundreds of factory-programmed Combinations. You can create your own original combinations by editing these factory-set combinations, or by initializing a combination and starting “from scratch.”

Over 1,400 Combination slots are left open for your own programming, or additional sound libraries.

These Combinations are organized into 14 Banks of 128 Combinations each, as described below. You can also store many more Combinations on the internal drive, or on external USB 2.0 devices.

For more details on the factory Combinations, please refer to the Voice Name List.

### Combination bank contents

Bank	No.	Description
INT-A...D	000...127	Factory Combinations
INT-E...G, USER-A...G	000...127	User Combinations

## Selecting with the front-panel buttons

### 1. Make sure that the COMBI button is lit.

This means that you're in Combination mode, in which you can select and edit Combinations. If the button isn't lit, press it now; it will light up, and the main Combination Play page will appear.

### 2. Go to the main Combination Play page.

The main Play page shows the selected Program, status, pan, and volume for timbres 1-16.

### 3. Make sure that the Combination name is selected.

If it is not selected, go to the Combination P0: Play page and touch the Combination's name, so that it's highlighted.

### 4. Use the VALUE controllers to select the Combination number that you wish to play.

You can use the following methods to select a Combination.

- Turn the **Value** dial.
- Press the Inc  $\wedge$  or Dec  $\vee$  buttons.
- Use the numeric keypad [0]–[9] to specify the number, and press the **ENTER** key.

### 5. Press a BANK button (INT or USER A-G) to switch banks.

When you select a different Bank, the button's LED will light, and the selected bank will appear on the upper left side of the LCD screen.

For example, to select bank INT-B, press the I-B button in the top row of Bank buttons. The I-B button will light, and the name INT-B will appear in the upper left of the LCD screen.

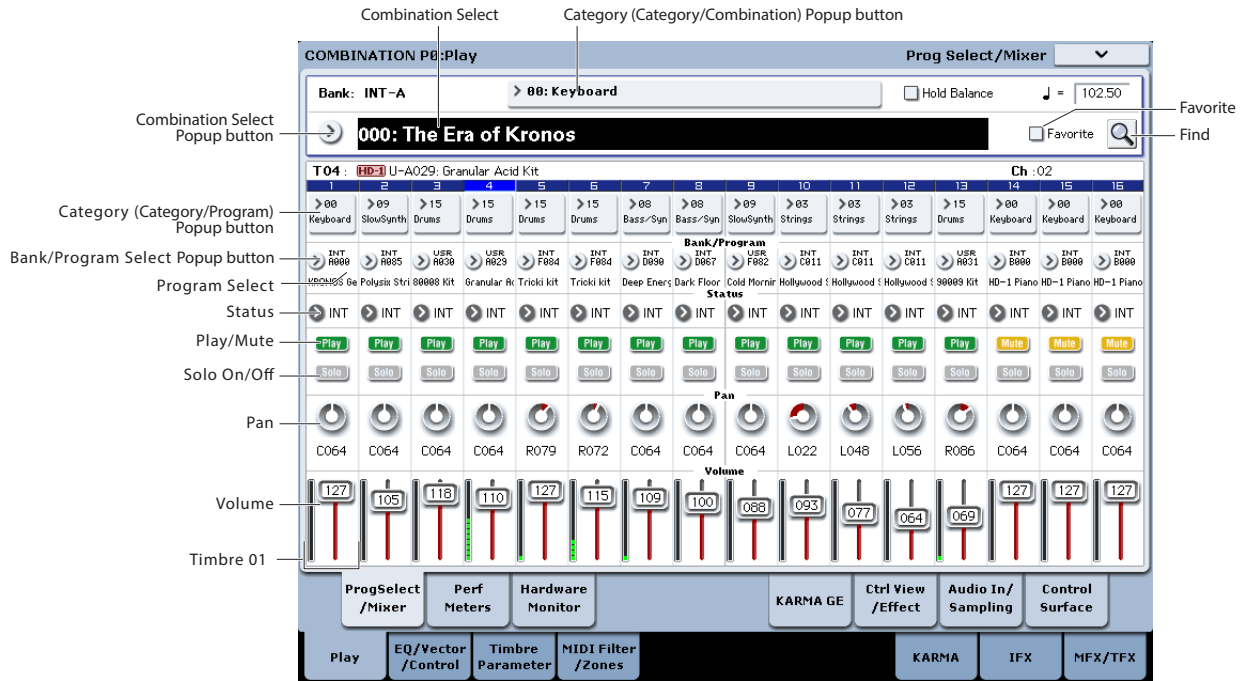

### Selecting by Bank and number

You can select Combinations from a list organized by Combination bank.

1. Press the Combination Select popup button.

The Bank/Combination Select dialog appears.

Bank/Combination Select menu:

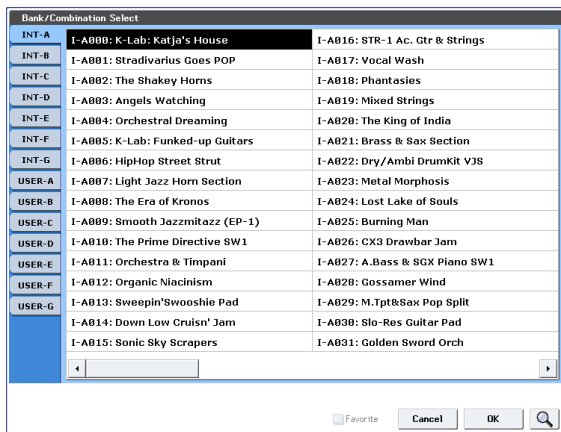

In this illustration, bank INT-A is selected. The list on the right shows the Combinations contained in that bank.

2. Press the tabs on the left side of the display to select a bank.
3. Press one of the names in the list to select a Combination.

The selected Combination will be highlighted and the keyboard will immediately switch to the new sound.

4. If you like, play a few notes to hear the new Combination.

You can play the new Combination while the menu is still showing, without needing to press OK.

5. When you are satisfied with the selected Combination, press the OK button to close the popup menu.

If you press the Cancel button, the selection you made here will be discarded, and you will return to the Combination that had been selected before you opened the menu.

### Selecting by Category

You can select Combinations from within a category, such as keyboard, organ, bass, and drums. When shipped from the factory, the Combinations are organized into 16 categories, each with several sub-categories. There are also 2 more categories, initially named User 16 and User 17, which you can use and rename as desired.

1. Press the Category popup button.

The Category/Combination Select dialog appears.

Category/Combination Select menu

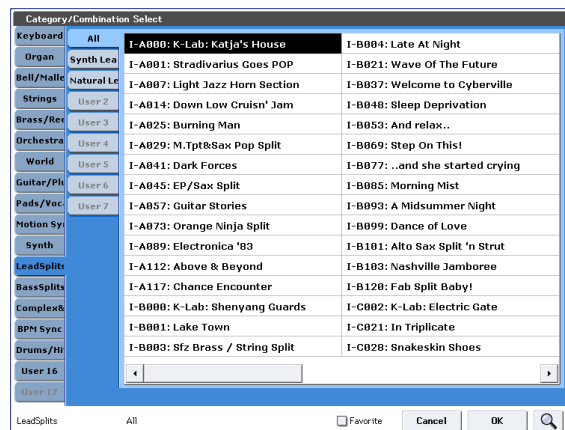

In the illustration above, the Keyboard category is selected. The list on the right shows the Combinations which belong to that category.

2. Press the tabs located to the left side of the display to select a different category.

The name of the selected category will be displayed in full in the lower left of the display.



3. **Optionally, focus on a more specific group of sounds by selecting a sub-category from the second column of tabs.**

The full name of the sub-category also appears in the lower left of the display.

4. **Press one of the Combination names in the center area to select a Combination.**

The selected Combination will be highlighted.

5. **When you are satisfied with the selected Combination, press the OK button to close the popup menu.**

If you press the Cancel button, your selection will be discarded, and you will return to the Combination that had been selected when you opened the popup menu.

---

## Using the Find feature

Near the top right corner of the Combinations P0:Play page, you'll see a button marked with a magnifying glass. Pressing this button brings up the Find dialog. You can use Find to search for Combinations by name. For more information, see "Using the Find feature" on page 33.

---

## Using the Favorites check-box

The Bank and Category select pop-ups both include a **Favorite** check-box at the bottom of the screen. This lets you trim the list to show only Combinations you've marked as favorites. For more information, see "Using the Favorites check-box" on page 33.

---

## Using a footswitch to select Combinations

You can assign a footswitch to step through Combinations one by one, either going up (0, 1, 2, 3, etc.) or going down (3, 2, 1 etc.). This lets you change Combinations without using your hands—great for quick Program changes in live performance situations.

For more information, see "Using a footswitch to select Programs" on page 33.

---

## Selecting Combinations via MIDI

You can send MIDI Program Change messages to KRONOS from external MIDI devices, such as computer sequencers or other MIDI controllers. In conjunction with MIDI Bank Select, you can use these to select any Combination from all 14 Banks.

For more information, see "Selecting combinations," on page 1134 of the Parameter Guide.

---

## Using controllers to modify the sound

You can use the joystick, ribbon controller, SW1, SW2, Vector Joystick, VALUE slider, keyboard, foot pedals and switches, and the Control Panel knobs, sliders, and switches to control the sound.

For more information, see the corresponding explanation for Programs: "Using Controllers" on page 35.

---

## Drum Track

The Drum Track integrates with all the other features of Combination mode, including KARMA. For details, see "Using the Drum Track in Combination mode" on page 252.

## Easy Combination editing

### Changing the Programs within a Combi

Changing the Programs assigned to the 16 Timbres is a quick way to dramatically alter the sound of the Combination.

There are two ways to select Programs for a Timbre:

- Selecting Programs from the front panel and LCD, either by Bank or by Category
- Selecting Programs via MIDI program change messages

Note: MIDI program changes only work for Timbres whose Status is set to INT.

#### Selecting Programs for Combi Tracks

To change the Program assigned to a Timbre:

**1. Go to the Prog Select/Mixer tab of the Play page.**

This page shows all 16 Timbres at once, including their Program assignments, volume, pan, play/mute, solo, and more.

**2. Touch the popup button at the top of Timbre 1.**

This is the Category select button. It brings up a window which allows you to select a Program by Category, identical to the similar function in Program mode.

**3. Select a Program, and press OK.**

The Category Select window will disappear. Note that the new Program is now selected for Timbre 1.

**4. Press the popup button directly under the Category button.**

This is the Bank/Number select button. It brings up a window which lets you select Programs by Bank—again, just like the similar window in Program mode.

**5. Select a different Program, and press OK.**

The Program in the Timbre is now changed to the one you just selected. Also, the Bank /Number parameter is now highlighted, which means that we can use the front panel buttons to select Banks and Programs.

**6. Press one of the front-panel Bank buttons.**

or:

**To select banks USER-AA...GG, press and hold a pair of I and U BANK buttons together. For example, to select bank USER-CC, press and hold the I-C button, and then press the U-C button.**

Notice that Timbre 1's Bank and Program change to match the selected Bank.

**7. Use Inc/Dec, the VALUE dial, or the numeric keypad to select the Program.**

### Adjusting the mix

You can use both the Control Surface and the LCD to set the volume, pan, and EQ settings for each Timbre, as well as their PLAY/MUTE and Solo On/Off states.

#### Setting mix parameters from the LCD

**1. Go to the Prog Select/Mixer tab of the Play page.**

This page shows the volume, pan, play/mute, solo, and Program assignments for all 16 Timbres.

**2. Select the on-screen Volume slider for Timbre 1.**

**3. Use Inc/Dec, the VALUE dial, or the numeric keypad to set the volume as desired.**

**4. Select the on-screen Pan knob for Timbre 1, and edit its value as desired.**

Timbre pan interacts with the pan stored in the Program. A setting of C064 reproduces the Program's oscillator pan settings. Adjusting the Timbre Pan will move the sound to left or right while preserving the pan relationship between the oscillators. A setting of L001 is far left, and R127 is far right.

**2. Optionally, go to the Control Surface tab of the Play page.**

**3. Press the MIXER KNOBS button until the INDIVIDUAL PAN LED lights up.**

This makes knob 1 control Timbre 1's pan, and knob 2 control Timbre 2's pan, and so on.

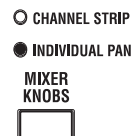

**4. Use sliders 1 -8 to adjust the volumes of Timbres 1-8, respectively.**

**5. Use knobs 1-8 to adjust the pan positions of Timbres 1-8.**

**6. Press the MIXER KNOBS button until the CHANNEL STRIP LED lights up.**

This makes the knobs control a virtual channel strip, including pan, EQ, and effects sends.

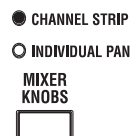

**7. Press MIX SELECT button 1.**

The Channel Strip now controls the Pan, EQ, and FX Sends for Timbre 1.

**8. Use knobs 2-6 to adjust the Timbres's 3-band EQ, and knobs 7 and 8 to control the Timbre's Effects Sends 1 and 2.**

Internally, the system figures out how the Oscillator is routed to the Master Effects, and automatically adjusts the appropriate effects send parameters.

#### Using the Control Surface for the mix

You can also edit the mixer parameters directly from the Control Surface, eight Timbres at a time.

**1. Press the TIMBRE/TRACK button under CONTROL ASSIGN, so that the 1-8 LED lights up.**

The button has two LEDs: one for Timbres 1-8, and the other for Timbres 9-16. Press the button to switch between the two.

**9. Press MIX SELECT button 2.**

The Channel Strip now controls the Pan, EQ, and FX Sends for Timbre 2. Each Timbre has its own, dedicated stereo 3-band EQ.

**10. Edit the Channel Strip for Timbre 2 as desired.**

Notice that Pan is available, in different ways, with both settings of the **MIXER KNOBS** button.

---

## Easy KARMA editing

KARMA stands for “Kay Algorithmic Realtime Music Architecture.” It’s an immensely powerful performance tool, and can provide a wide range of musical effects including:

- Arpeggiation
- Drum and instrument grooves
- Complex CC gestures (as if it was automatically moving knobs or joysticks for you)
- Musical phrase generation
- Any combination of the above
- ...and much more.

You can control many KARMA parameters directly from the front panel.

The LCD will now show the KARMA parameters assigned to the sliders and switches.

**3. Move the sliders to change the KARMA parameters.**

For more information on KARMA, see “Using KARMA” on page 225.

---

### Turning KARMA on and off

The overall control for KARMA is the ON/OFF button. Turn the button on (LED lit) to enable KARMA; turn the button off (LED off) to disable KARMA.

---

### LATCH button

When LATCH is turned on, KARMA will continue to play even after you’ve stopped playing on the keyboard, drum/chord pads, or MIDI In.

This is convenient when you want to play on top of a KARMA-generated groove, for instance.

---

### Selecting KARMA Scenes

Each Combi can have up to 8 KARMA “Scenes,” which are presets for the KARMA parameters. Different Scenes may produce dramatically different effects. You can select Scenes directly from the Control Surface:

**1. Press the RT KNOBS/KARMA button under CONTROL ASSIGN.**

The Control Surface will switch to Real-Time Knobs and KARMA mode.

**2. Select Scenes by pressing the top row of Control Panel switches.**

Note that not all Combis will necessarily have 8 different Scenes.

---

### Editing KARMA parameters via the sliders

You can also edit various KARMA parameters in real time, using the Control Surface sliders. The specific parameters will vary depending on the Combi, so it may be helpful to look at the LCD:

**1. Go to the Control Surface tab of the Play page.****2. Press the RT KNOBS/KARMA button under CONTROL ASSIGN.**

## Detailed Combination editing

You can edit any of the Combinations shipped with KRONOS, or you can start with an initialized Combination to create sounds from scratch.

Naturally, you can use the factory Programs to create new Combis, or use your own custom Programs. If you're in the process of editing a Program in Program mode, and you use the Program in a Combi, you'll hear the edited version in Combi mode as well.

As with Programs, you can do many basic edits directly from the front panel Control Surface knobs, switches, and sliders, without ever delving deeper into the LCD interface. For instance, you can use the knobs to change attack and release times, make sounds brighter or darker, alter effects depths, modulate KARMA's phrase generation, and so on. For details on how these work in Program mode, see "Quick edits using the knobs, sliders, and switches" on page 43.

### A suggested approach for editing

First, select a Program for each Timbre, on the Prog Select/Mixer tab of the P1: Play page. (Note that you don't have to use all 16 Timbres!)

Next, create any desired keyboard or velocity splits, layers, or crossfades between the different Timbres. You can do this on the Keyboard Zones and Velocity Zones tabs of the P3: MIDI Filter/Zones page.

After this, adjust the volumes of the Timbres (back on the Prog Select/Mixer tab), and set up any other Timbre parameters as desired.

To add finishing touches to the sound, set up the Insert, Master, and Total Effects as desired (on the P8: Insert Effects and P9: Master/Total Effects pages, respectively.) These effects can be different from those of the individual Programs in Program mode, if desired.

In addition, you can make KARMA settings (on the P7: KARMA page) and controller settings (on the P3: MIDI Filter/Zones page) to create the finished Combination.

### Soloing timbres

You can use the Control Surface Solo function to listen to the Combi's individual Timbres. For more information, see "Solo switch and Select switches 1-8" on page 434.

### Using COMPARE

When you're in the process of editing a sound, pressing the COMPARE button will recall the saved version of the sound, as it was before you started editing. To indicate that you are listening to the saved version, the button's LED will light up.

Pressing COMPARE again returns you to the version you are editing, and the LED will go out again.

If you edit while the COMPARE LED is lit, the key will again go dark and your previous edits will be lost.

### Resetting individual controls

The RESET CONTROLS button lets you revert an individual knob, slider, or switch to its saved setting. For more information, see "Resetting individual controls" on page 46.

## Combination overview

### Combination page structure

The main P0: Play page offers access to the most important aspects of Combis, including:

- Selecting and playing Combinations
- Selecting individual Programs
- Making basic settings for KARMA
- Editing mixer settings and sound parameters via the Control Surface
- Quick sampling and resampling

The detailed editing pages, P1 through P9, give you more in-depth access to the Combi's powerful key and velocity zones, MIDI filtering, Vector Synthesis, KARMA, Drum Track, and Effects.

Page	Main features
P0: Play	<ul style="list-style-type: none"> <li>• Select and play Combinations</li> <li>• Perform easy edits using the Realtime Knobs, KARMA sliders, and Tone Adjust</li> <li>• Adjust mix parameters including volume, pan, EQ, and send levels</li> <li>• Select a Program for each timbre</li> <li>• Quick sampling and re-sampling</li> </ul>

Page	Main features
P1:EQ/Vector/Control	<ul style="list-style-type: none"> <li>• Adjust EQ settings for each Timbre</li> <li>• Assign functions to SW1/2 and Real-Time knobs 5-8</li> <li>• Set up Vector synthesis</li> <li>• Set up the Drum Track</li> <li>• Set up the on-screen pads</li> </ul>
P2: Timbre Params	<ul style="list-style-type: none"> <li>• Set various parameters for each timbre, such as MIDI channel, OSC select, Pitch etc.</li> </ul>
P3: MIDI Filter/Zone	<ul style="list-style-type: none"> <li>• Set up MIDI transmission/reception filters for each Timbre.</li> <li>• Set up keyboard and velocity zones for each Timbre.</li> </ul>
P4:	---
P5:	---
P6:	---
P7: KARMA	<ul style="list-style-type: none"> <li>• Make detailed KARMA settings.</li> </ul>
P8: Insert Effects	<ul style="list-style-type: none"> <li>• Select insert effects and make settings for them. Specify send levels to the Master effects and routing to the outputs.</li> </ul>
P9: Master and Total Effects	<ul style="list-style-type: none"> <li>• Select Master send effects and Total effects, and adjust their settings.</li> </ul>

For details on how to access each mode and page, please see "Basic operations" on page 17.

You can sample from within Combination mode—including resampling the Combination itself. For more information, see “Sampling in Program and Combination modes” on page 156.

You can also mix in live audio inputs, and process them through effects. For more information, see “Using effects with the audio inputs” on page 219.

Combination structure and corresponding pages

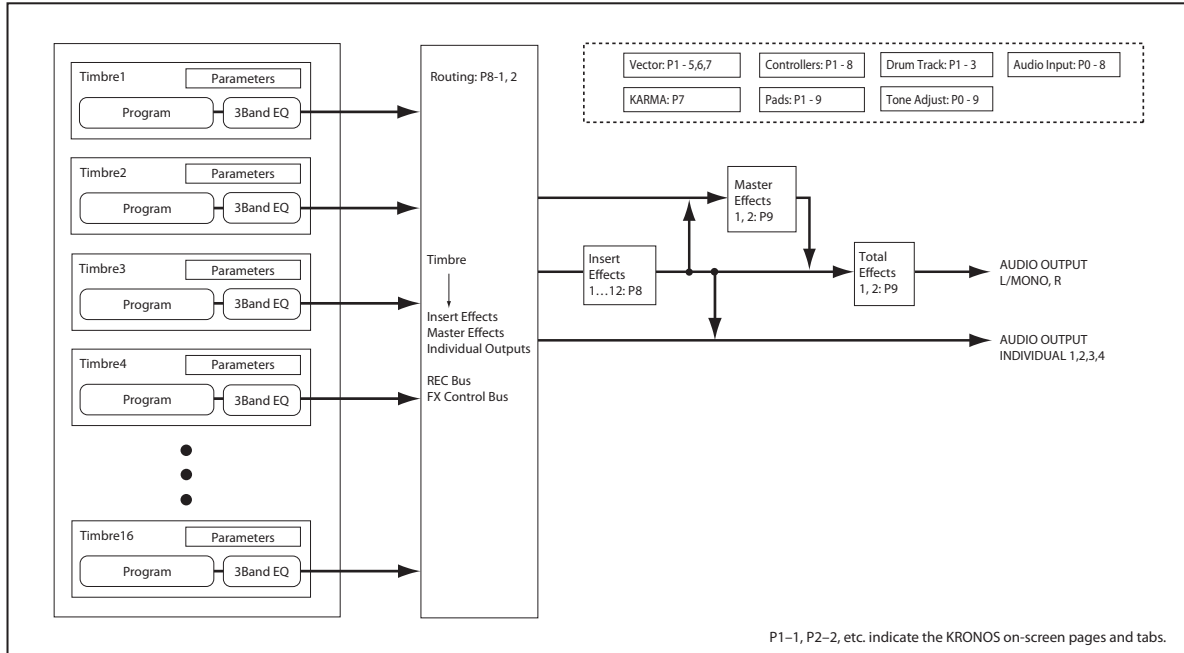

## Layers, Splits, and Velocity Switches

Within a Combination, you can use note number and velocity to determine which Timbres will sound.

The Programs assigned to each Timbre can sound in three ways: as part of a **layer**, a **split**, or a **velocity switch**. A Combination can be set to use any one of these methods, or to use two or more of these methods simultaneously.

### Layer

Layers cause two or more Programs to sound simultaneously when a note is played.

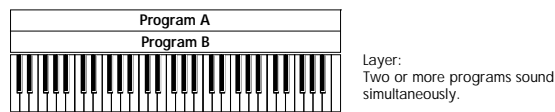

### Split

Splits cause different Programs to sound on different areas of the keyboard.

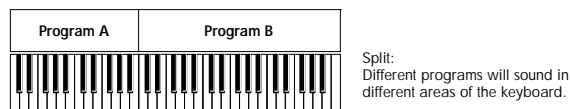

### Velocity Switch

Velocity Switches cause different Programs to sound depending on the velocity (how hard you play the notes).

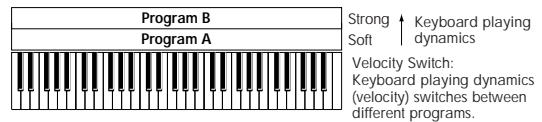

On KRONOS, you can use a different Program for each of up to sixteen Timbres, and combine two or more of the above methods to create even more complex setups.

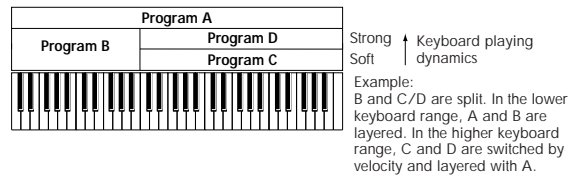

As an additional possibility, you can set the slope for a key zone or velocity zone so that the volume diminishes gradually. This lets you change a split into a keyboard crossfade, or a velocity switch into a velocity crossfade.

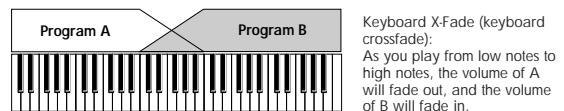

## Creating Key Splits and Layers

Let's create a Combi which combines both splits and layers, like the diagram below:

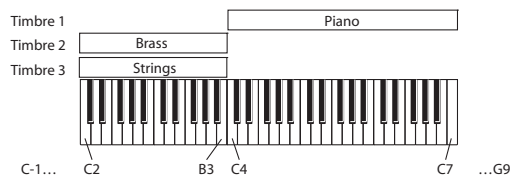

1. Go to the Prog Select /Mixer page.
2. Select a piano sound for Timbre 1, a brass sound for Timbre 2, and a strings sound for Timbre 3.
3. Go to the MIDI tab of the P2: Timbre Parameters page.
4. For Timbres 1-3, set Status to INT and MIDI Channel to Gch (the Global Channel).
5. Go to the Keyboard Zones tab of the MIDI Filter/Zones page.
6. Set Timbre 1's Top Key to G9, and its Bottom Key to C4.
7. Set Timbres 2 and 3 to a Top Key of B3, and a Bottom Key of C-1.

You can also enter these values by selecting the parameter, and then holding down the ENTER key and playing a note on the keyboard.

### Key Zone Slope

In addition to "hard" splits, in which the sound changes abruptly, you can use the Slope parameters to gradually fade a sound in or out over a range of keys.

In the example above, you could set the Bottom Key of timbre 1 to G3, and set the Top Key of timbre 2 to G4, so that these two timbres overlap.

Next, if you set the **Bottom Slope** of timbre 1 to 12, and set the **Top Slope** of timbre 2 to 12, the sound will change gradually instead of changing suddenly.

## Creating Velocity Switches

Next, let's create a simple velocity switched Combination, like the diagram below:

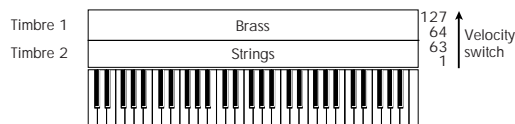

1. Go to the Prog Select /Mixer page.
2. Select a brass sound for Timbre 1, and a strings sound for Timbre 2.
3. Go to the MIDI tab of the P2: Timbre Parameters page.
4. For Timbres 1 and 2, set Status to INT and MIDI Channel to Gch (the Global Channel).
5. Go to the Velocity Zones tab of the MIDI Filter/Zones page.
6. Set Timbre 1's Top Velocity to 127, and its Bottom Velocity to 64.
7. Set Timbre 2 to a Top Velocity of 63, and a Bottom Velocity of 1.

### Velocity Zone Slope

Similar to Key Zone Slopes, as described above, these let you fade in and fade out sounds gradually over a velocity range, instead of a simple hard switch.

In the case of the above example, you could set the velocity zones of the two Timbres so that they partially overlap. Then, set the Top Slope and Bottom Slope so that the sound changes gradually, instead of changing suddenly between velocity values of 63 and 64.

## MIDI Settings

### Timbre Parameters MIDI page

#### Status

This controls the status of MIDI and the internal tone generator for each Timbre. Normally, if you're playing an internal Program, this should be set to INT.

If the status is set to **Off**, **EXT**, or **EX2**, that internal sounds will not be played. **Off** simply disables the Timbre entirely. The **EXT** and **EX2** settings allow the Timbre to control an external MIDI device. For more information, see "Status" on page 458 of the Parameter Guide.

#### Bank Select (when status=EX2)

When the **Status** is set to **EX2**, these parameters allow you to transmit MIDI Bank Select messages for changing banks on external MIDI devices.

#### MIDI Channel

Timbres that you wish to play from KRONOS's keyboard must be set to the global MIDI channel. Your playing on the keyboard is transmitted on the global MIDI channel, and will

sound any timbre that matches this channel. Normally you will set this to Gch. When this is set to **Gch**, the MIDI channel of the timbre will always match the global MIDI channel, even if you change the global MIDI channel.

- On some preloaded combinations, Timbres used by KARMA may have their MIDI Channels set to something other than Gch. These will be timbres that play only when KARMA is on—a very useful technique for creating "KARMAized" combinations.

For more information, see "7-1c: MIDI I/O" on page 475 of the Parameter Guide. In particular, note the relationships between KARMA assignments and MIDI Channel.

### MIDI filter settings

For each MIDI Filter item, you can specify whether or not the corresponding MIDI message will be transmitted and received. The **checked** items will be transmitted and received.

The MIDI filters don't turn the functions themselves on or off. Instead, the filter just controls whether or not that MIDI message will be transmitted and received.

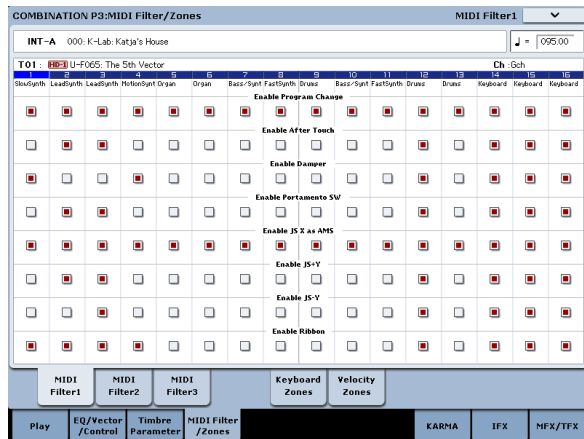

For example, if portamento is on, portamento will be applied to the internal KRONOS sound even if Portamento SW CC#65 is unchecked.

As another example, let's say that you've selected a bass Program for Timbre 1, and a piano Program for Timbre 2, with the goal of creating a bass/piano split. You could make the following settings so that pressing the damper pedal affects only Timbre 2's piano sound:

1. Go to the MIDI Filter 1 tab of the MIDI Filter/Zones page.
2. Check the Enable Damper box for Timbre 1.
3. Un-check the Enable Damper box for Timbre 2.

## Altering Programs to fit within a Combination

You can make various changes to Programs within the context of a particular Combination, to make them fit better with other Programs, or to create particular sonic effects. These changes do not affect the original Programs, or how those Programs sound in other Combinations.

### Timbre Parameters: OSC

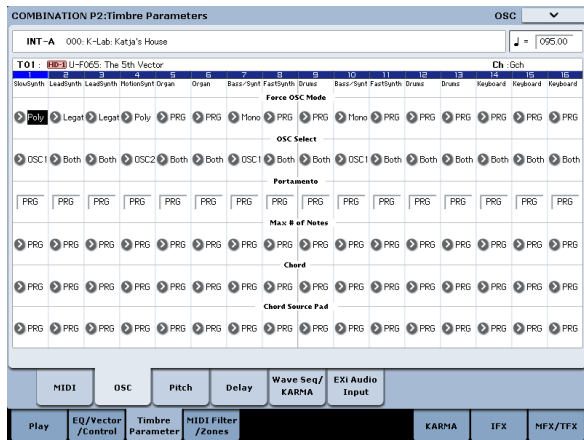

#### Force OSC Mode

Normally this should be set to **PRG**, so that the sound will play as set by the original Program.

If you wish to force a polyphonic program to sound monophonically, set this either to **Mono** or **Legato**. Conversely, set this to **Poly** if you wish to force a monophonic program to play polyphonically.

For more information, see "Force OSC Mode," on page 459 of the Parameter Guide.

#### OSC Select

Normally, this should be set to **BTH** (Both).

If the timbre is using a program whose **Oscillator Mode** is **Double** or **Double Drums**, and you want only OSC1 or OSC2 (not both) to sound, set this to **OSC1** (only OSC1 will sound) or **OSC2** (only OSC2 will sound).

### Portamento

Normally, this should be set to **PRG**.

If the Program uses portamento, but you'd like to disable this for the current Combination, set this parameter to **Off**.

Conversely, if you want to force the portamento to be on, or just to change the portamento time, set this to a value of **001–127**. The portamento will change to use the newly specified time.

### Timbre Parameters: Pitch

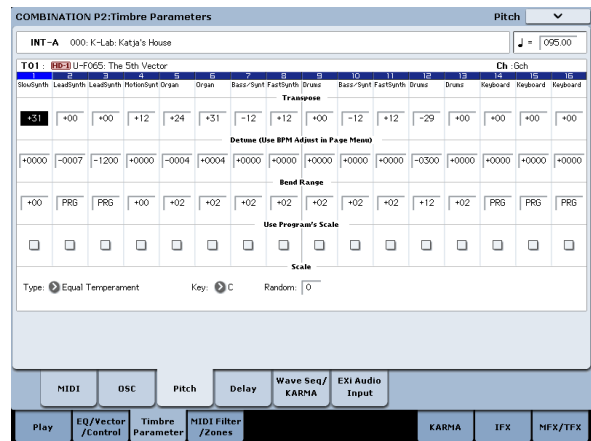

#### Transpose, Detune (BPM Adjust)

These parameters adjust the pitch of the timbre.

- In a layer-type combination, you can set two or more timbres to the same program, and create a richer sound by using **Transpose** to shift their pitch apart by an octave or by using **Detune** to create a slight difference in pitch between the two.
- In split-type combinations, you can use **Transpose** to shift the pitch (in semitone units) of the programs specified for each key zone.
- If you wish to change the playback pitch of a drum program, use **Detune**. If you change the **Transpose**



setting, the relationship between notes and drum sounds will change.

### Adjusting the BPM of multisamples or samples created in Sampling mode

If a timbre's program uses multisamples or samples that you created in Sampling mode (or loaded in Disk mode) at a specific BPM value, you can use the page menu command Detune BPM Adjust to call up a new BPM value. This changes the BPM by adjusting the playback pitch.

For more information, see "Detune BPM Adjust," on page 508 of the Parameter Guide.

### Use Program's Scale, Scale

This specifies the scale for each timbre. If you check **Use Program's Scale**, the scale specified by the program will be used. Timbres for which this is **not checked** will use the **Scale** setting.

---

### Delay

You can set some Timbres so that they don't sound immediately at note-on. This can create cool effects, and more dramatic layers.

You can specify the delay for each Timbre either in milliseconds (ms), or in rhythmic values which sync to the system tempo.

If you set the Delay to **Key Off**, the Timbre will sound when the note is released.

---

## Editing Programs from within a Combination or Song

If you want to dive in deeper than Tone Adjust allows, you can also go directly into the editing pages of a Program from within a Combination or Song—while still hearing all of the other Timbres or Tracks.

**Important:** Tone Adjust lets you change the way the Program sounds in a specific Combination or Song without affecting the original Program. In contrast, the method described below changes the original Program, and will affect any Combinations or Songs which use that Program.

To edit a Program within a Combination or Song:

1. **Go to the P0-1: Prog Select/Mixer page in Combination mode, or the P0-1: MIDI Prog Select/Mixer page in Sequencer mode.**

To edit a Program in context, either:

2. **Select any parameter in the column of the Timbre or Track which contains the Program you'd like to edit, and then select the Edit Program command from the menu.**

You can select any parameter in the Timbre/Track's column, including Volume, Pan, Status (Combinations only), and Program Bank/Number.

Note: this is different from selecting a Timbre or Track via the Control Surface.

or:

- 2a. **Hold the ENTER button, and then touch the Program's name in the Timbre or Track.**

---

## Editing Programs with Tone Adjust

Using Tone Adjust, you can make detailed edits to Programs within the context of the Combi. These edits will not affect the original Program, or any other Combis which use the Program. To edit a Program with Tone Adjust:

1. **Press the TONE ADJ/EQ button under CONTROL ASSIGN.**

The TONE ADJUST LED will light up.

2. **Go to the Control Surface tab of the Play page.**

This page mirrors the Control Surface. It's very useful with Tone Adjust, since it shows you the parameter assignments, exact values, and so on.

3. **Select the Timbre whose parameters you'd like to adjust.**

This corresponds to the Timbre selected in TIMBRE/TRACK mode. You can set this using the Timbre parameter on the right side of the LCD, or by holding down the TONE ADJ/EQ button and pressing any of the Control Panel switches. The top row selects Timbres 1-8, and the bottom row selects Timbres 9-16.

4. **Edit the controls as desired.**

In addition to editing the values, you can also change the assignments of Tone Adjust parameters to the sliders, knobs, and switches. For more information, see "Using Tone Adjust" on page 45.

The system will then display the P0 page for the selected Program. The front-panel PROG button's LED will blink, and the COMBI or SEQ LED will remain solidly on, to show that you are editing the Program in context.

3. **Edit as desired.**

Eventually, if you want to keep your changes, you'll need to Write the Program. However, while you're working, you can go back and forth between the edited Program and the Combination or Song.

You'll notice that some Program pages and tabs will be grayed out; for more information, see "Parameters unavailable while editing in context," below.

To return to the Combination or Song:

4. **Press the front-panel COMBI or SEQ buttons.**

or:

- 4a. **Press the EXIT button until the Program P0 page appears, and then press EXIT once again.**

To go back to editing the Program, just repeat steps 2 or 2a, above.

The normal rules of editing apply: if you select another Program, all edits to the previous Program will be lost. So, make sure to save your work:

5. **While on the Program edit pages, use the Write menu command to save your edits.**

Note that you must be on the Program edit pages in order to Write the Program edits. Writing the Combination or Song will not affect the Program.

If you Write the Program to different bank/number, the Combination Timbre or Song Track selected in step 2 or 2a, above, will be updated to reference the new location. In this case, if other Timbres or Tracks use the Program, they will not be updated automatically (since you may want them to continue to play the original Program); you can change them manually if desired.

### Parameters unavailable while editing in context

When editing a Program in context, you'll hear the Combination or Song's effects, EQ, KARMA, and Drum Track. The Control surface will only apply to the Osc levels. Because of this, related pages, tabs, parameters, and functions within the Program will be grayed out and unavailable, including:

- P-01: Play: The "jump" buttons for EQ, KARMA, IFX, and MFX/TFX are grayed out.
- P0-6: KARMA GE
- P0-7: Controller View/Effect
- P0-8: Audio Input/Sampling
- P0-9: Control Surface: all side tabs except for OSC 1/2 are grayed out, the Mixer Knobs are set to Individual Pan, and the OSC 1/2 and Drum Track levels are not shown
- P1-3: Drum Track
- P1-8: Set Up Controllers
- P1-9: Pads
- Program EQ (HD-1 4-9: EQ or EXi P6: EQ)
- EXi Program P4-1: Program Basic: EXi1 and 2 Instrument Types are read-only
- P7: KARMA

- P8: IFX
- P9: MFX/TFX
- Tempo is not available
- The Auto Song Setup feature is not available

### Playing the Program during editing, from the keyboard and MIDI

While editing a Program in context, input from the keyboard and MIDI continues to play the Combination or Song exactly as it did before. For instance, MIDI Channels, Key and Velocity Zones, Solo and Mute, etc. continue to apply. This is important, since it lets you hear the Program exactly as it will play in the finished Combination or Song.

Note that this means that if the local keyboard does not play the selected Program in Combination or Sequencer modes (for instance, if you're in a Combi and the Timbre is not on the Global MIDI Channel), then the keyboard will still not play the Program during editing. If the sound is being played by other means—for example, from the KRONOS sequencer, KARMA, or an external DAW or MIDI controller—then this may not matter. If necessary, you can use various means to route the keyboard to the Program, such as:

- Use MIDI Thru on an external DAW
- In Sequencer mode, set the Keyboard Track to play the desired Track
- In Combination mode, temporarily change the Timbre/Track's MIDI channel, and/or adjust Key or Velocity zones

Of course, if you want to edit the Program by itself, unaffected by the context of the Combination or Song, simply go to Program mode and edit the sound there!

## Effects

Effects are covered in their own section of the manuals, so we won't go into too much detail here.

### Insert Effects

Insert Effects let you send either individual Oscillators or the entire Program through up to 12 effects, in series. You can use any type of effects, from distortions and compressors to choruses and reverbs. The Insert Effects can be routed to the main outputs, or to any of the individual outputs.

For more information, see "Insert effects" on page 214.

### Master Effects

There are two Master Effects, which are accessed through Sends 1 and 2. These are best-suited to effects such as reverbs and delays, but you can use them with any type of effect.

For more information, see "Master effects" on page 215.

### Total Effects

The two Total Effects are dedicated to processing the main L/R outputs. They're ideally suited to overall mix effects, such as compression, limiting, and EQ—but as with the other effects sections, you can use any type of effect that you like.

## Automatically importing a Combination into Sequencer mode

The Auto Song Setup feature automatically applies the settings of the current Combination to a song.

If inspiration for a phrase or song strikes you while you're playing a program or combination, you can use this function to start recording immediately.

Hold down the **ENTER** key and press the **SEQUENCER REC/WRITE** key. The "Setup to Record" dialog box will open and ask "Are you sure?". Press "OK". You will

automatically enter Sequencer mode, and will be in the record-ready state. Press the **START/STOP** key to start the sequencer and begin recording.

### Saving your edits

Once you've tweaked the sound to perfection, you'll want to save your work. To save your edits:

- 1. Select the Write Combination command from the page menu, at the upper right-hand corner of the screen.**

You can also call up this menu command by holding **ENTER** and pressing **0** on the numeric keypad.

This brings up a dialog box which allows you to save the Combination. Optionally, you can also select a new location, or change the Combination's name.

- 2. Press the "T" button to bring up the text edit dialog.**

You can give the Combination a descriptive name using the on-screen keyboard.

- 3. After entering the name, press OK.**

The text edit window will disappear, returning you to the main Save dialog.

- 4. Under "To" at the bottom of the dialog, press the popup button next to Combination to bring up the save location dialog.**

- 5. Select a location to save the edited Combination.**

You can write to any location in banks INT and USER A-G. To avoid overwriting the factory sounds, it's safer to use a slot in one of the empty User banks.

- 6. After selecting the location, press OK.**

- 7. Press OK again to start the write process.**

- 8. If you're sure you want to write to this location, press OK again.**

After that, you're done!

For more information, see "Writing Programs and Combinations" on page 192.

-  Do not turn off the power for at least 10 seconds after writing the Combination. This allows the system time to complete the process, which includes saving a backup of the data to the internal disk.

### Saving to disk

You can also save and manage Combinations on the internal disk and USB storage devices. For more information, see "Saving to disks, CDs, and USB media" on page 196.

# Creating songs (Sequencer mode)

## Sequencer overview

---

### About the KRONOS' sequencer

The KRONOS' sequencer can hold up to 200 songs and 400,000 MIDI events or 300,000 audio events. It consists of a 16-track MIDI sequencer and a 16-track audio recorder, giving you a total of 32 tracks.

Via MIDI, you can record from and play through external MIDI devices, as well as the KRONOS keyboard, physical controllers, and internal sounds.

The 24-bit, 48kHz audio recorder supports 16 tracks of playback and four simultaneous channels of recording. Audio tracks can record external audio sources such as guitars and vocals as well as the KRONOS' internal sounds. You can even record mix automation for volume and pan.

When you've completed a song, you can resample it to a WAVE file and use Disk mode to burn your WAVE files to an audio CD on a USB CD-R/RW drive (not included).

With its broad range of capabilities such as In-track Sampling, Time Stretch/Slice, KARMA, high-quality effects, and physical controllers, the KRONOS is the ideal environment for music production or live performance.

---

## Sequencer mode structure

### Songs

A song consists of MIDI tracks 1–16, a master track, audio tracks 1–16, song parameters such as the song name, Vector, KARMA, Drum Track, effects, and RPPR settings, and 100 user patterns.

A maximum of 200 songs can be loaded into the KRONOS memory at once. Thousands can be stored on the internal disk, or on USB storage media.

MIDI tracks 1–16 and audio tracks 1–16 each consist of setup parameters located at the start location, and musical data within the track. The master track consists of tempo and time signature data.

For more information, see “Setup parameters & Musical data” on page 515 of the Parameter Guide.

### Song recording and editing

Song recording is performed on tracks. You can record MIDI tracks in either of two ways; real-time recording or step recording. For real-time recording you can choose one of six recording modes.

Audio tracks can be recorded in real-time, or created by adding WAVE files.

You can edit MIDI tracks by using Event Edit operations to modify the recorded data or insert new data, and by using Track Edit operations such as Create Control Data, which inserts pitch bend, aftertouch, or control change data.

You can also edit audio tracks in a variety of ways including Event Editing operations that let you insert or delete audio events, and Region Editing operations.

---

### Sequencer edits must be saved to disk

-  When you turn off the power, the settings made in Sequencer mode and the song data, and any user pattern data that you recorded will not be backed up. If you wish to keep this data, you must save it to the internal drive or an external USB device before turning off the power. (You could also do a MIDI data dump to an external data file, if you prefer.)

Immediately after the power is turned on, the KRONOS will not contain any song data. If you wish to play a song on the sequencer, you must first load data from disk. (Alternatively, you could send KRONOS a MIDI data dump with Song data). For more information, see “Loading data from disk” on page 200, and “Receiving SysEx data dumps” on page 809 of the Parameter Guide.

Region Editing allows you to select WAVE files and to edit the start/end addresses of a WAVE file in single-sample units.

---

### Patterns

There are two types of patterns: preset patterns and user patterns.

- **Preset patterns:** Patterns suitable for drum tracks are preset in internal memory, and can be selected for any song.
- **User patterns:** Each song can have up to 100 patterns. When using a pattern in a different song, use the Utility menu commands **Copy Pattern** or **Copy From Song** etc. to copy the pattern. You can set the pattern length to one or more measures, as desired.

Patterns always contain only a single track of musical data. If you want to use patterns on multiple tracks, you'll need to use a separate pattern for each track.

To use patterns in a Song, either place them in a MIDI track using the **Put to MIDI Track** menu command, or copy them using the **Copy to MIDI Track** menu command.

You can also use patterns with the RPPR. For more information, see “Using RPPR (Realtime Pattern Play/Record)” on page 112.

### Sequencer patterns and Drum Track patterns

Preset patterns are directly available for use as Drum Track patterns.

User patterns can also be used with the Drum Track, but they must first be converted into user Drum Track patterns (via the **Convert to Drum Track Pattern** menu command on P5: Pattern/RPPR).

When you convert a user pattern, it will be stored in internal memory, and will not disappear even when you turn off the power.

#### *Sequencer mode page structure*

Page	Explanation
P0: Play/REC	<ul style="list-style-type: none"> <li>• Song playback/recording</li> <li>• Easy editing using the realtime knobs, KARMA sliders, and Tone Adjust</li> <li>• Edit mix parameters such as volume, pan, Play/Mute, and Solo On/Off</li> <li>• Select programs for MIDI tracks</li> <li>• Choose the recording mode</li> <li>• Make settings for sampling, resampling, and audio</li> </ul>
P1: EQ/Vector/Controller	<ul style="list-style-type: none"> <li>• EQ adjustments for each track</li> <li>• Function assignments for the SW1 and SW2 switches and realtime knobs 5–8</li> <li>• Vector Synthesis settings</li> <li>• Drum Track settings</li> <li>• Assignments for the on-screen pads</li> </ul>
P2: Track Parameters	<ul style="list-style-type: none"> <li>• Parameter settings for each track (MIDI channel, OSC selection, pitch settings, etc.)</li> </ul>
P3: MIDI Filter/Zone	<ul style="list-style-type: none"> <li>• MIDI receive/transmit filter settings for each track</li> <li>• Keyboard zone and velocity zone settings for each track</li> </ul>
P4: Track Edit	<ul style="list-style-type: none"> <li>• Track editing</li> </ul>
P5: Pattern/RPPR	<ul style="list-style-type: none"> <li>• Pattern recording and editing</li> <li>• RPPR settings</li> <li>• Convert User patterns to User Drum Track patterns</li> </ul>
P6:	—
P7: KARMA	<ul style="list-style-type: none"> <li>• Detailed KARMA settings</li> </ul>
P8: Insert Effect	<ul style="list-style-type: none"> <li>• Insert effect selection, settings, send level to master effects, output routing</li> </ul>
P9: Master/Total Effect	<ul style="list-style-type: none"> <li>• Master effect and total effect selection and settings</li> </ul>

For details on how to access each mode and page, see “Basic operations” on page 17.

You can sample from within Sequencer mode—including resampling the Song itself. For more information, see “Sampling in Program and Combination modes” on page 156.

You can also mix in live audio inputs, and process them through effects. For more information, see “Using effects with the audio inputs” on page 219.

### Set Lists

Songs can also be selected in Set Lists, along with Programs and Combinations. For more information, see “Set Lists” on page 119.

This is a conceptual diagram of Sequencer mode including the hard disk recording function.

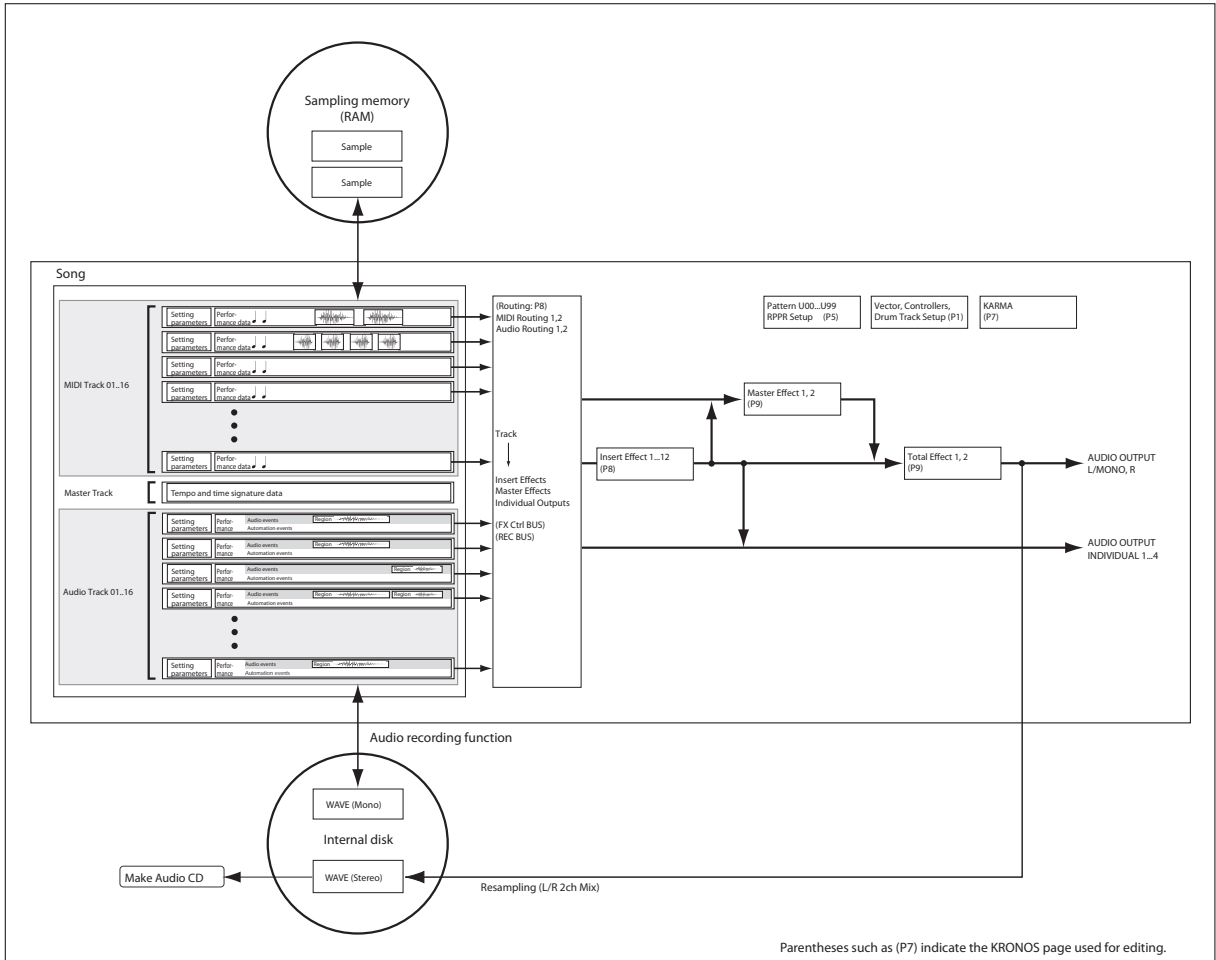

# Playing Songs

## Playback

In order to play back a Song in the sequencer, you must first either load the Song from disk, send the Song to the KRONOS via MIDI SysEx, or record a new Song.

Let's start by loading and playing the demo song data.

1. Follow the instructions for loading and playing the demo songs under "Listening to the demo songs" on page 26 of the Quick Start Guide.

Now, let's experiment with the different controls.

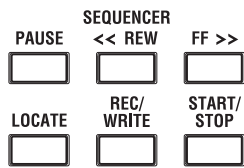

2. Press the SEQUENCER START/STOP button.

Pressing this once starts playback; pressing it again stops playback. Pressing it a third time resumes playback from where it stopped.

Note: SEQUENCER START/STOP has a special function on P5: Pattern/RPPR. On this page, instead of playing the Song, START/STOP plays the selected pattern.

3. Press the LOCATE button to return to the start of the Song.

The locate point defaults to the start of the Song. You can change this as desired; see "LOCATE settings" on page 79.

4. Press the PAUSE button to pause playback.

Press the PAUSE switch once again to resume playback.

5. Press the <<REW or FF>> buttons to rewind or fast-forward.

You can use <<REW and FF>> during playback or while paused. They are disabled during recording, and while the Song is stopped.

If you like, you can adjust the rewind and fast-forward speeds using the FF/REW Speed page menu command.

6. To set the tempo, turn the TEMPO knob or press the TAP TEMPO switch at the desired interval.

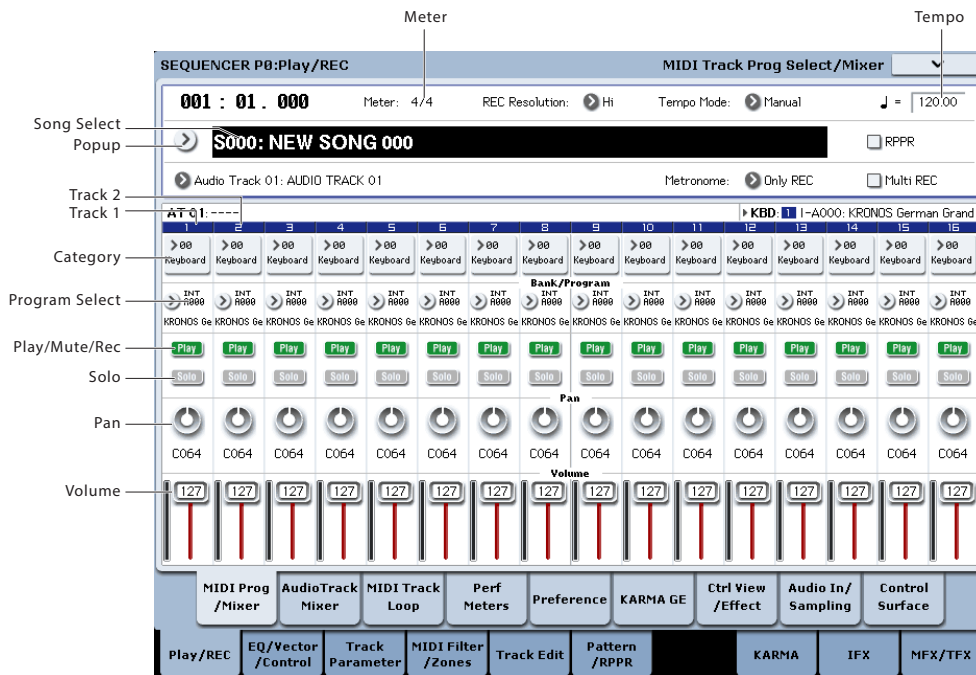
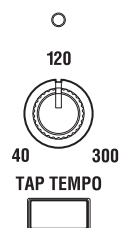

## Mute and Solo

Mute lets you silence any of the MIDI tracks 1–16, audio tracks 1–16, or any of the audio inputs (analog 1, 2, USB 1,2, S/P DIF L/R). Solo lets you hear any of these tracks or inputs by itself. These functions can be used in various ways. For example, you can listen only to the rhythm section of the previously-recorded tracks while you record new tracks. Let's try out the Mute and Solo functions.

1. Use "Song Select" to select the song that you want to play back.
2. Press the SEQUENCER START/STOP switch.

3. Press track 1 Play/Rec/Mute.

The display will change from **Play** to **Mute**, and the playback of track 1 will no longer be heard. In this way, the "mute" function allows you to silence a specified track until the track is un-muted.

Press track 2 **Play/Rec/Mute**. The display will change, and the playback of track 2 will also be muted. To cancel muting, press **Play/Rec/Mute** once again.





*Tip:* Play/Rec/Mute can be controlled from the front panel mixer section, or from the P0– Control Surface page of the LCD screen. (See “The control surface in Sequencer mode” on page 80.)

**4. Press track 1 “Solo On/Off.”**

“Solo” will be highlighted, and this time, only track 1 will be heard. This is known as “soloing” the track.

If both Mute and Solo are used, the Solo function will be given priority.

Press track 2 “Solo On/Off.”

The display will change, and you will hear the playback of tracks 1 and 2.

*Note:* Solo (on) applies to all tracks, including MIDI tracks 1–16, audio tracks 1-16, and all audio inputs (analog, USB, and S/P DIF). If, as in this example, you’ve turned Solo on for only MIDI tracks 1 and 2, you will not hear MIDI tracks 3–16, audio tracks 1–16, or any of the audio inputs.



**5. To switch Solo off, press Solo On/Off once again. Press Solo On/Off for both MIDI tracks 1 and 2.**

The display will change, and the playback of tracks 1 and 2 will be muted. If the Solo function is turned off for all tracks, playback will be according to the **Play/Rec/Mute** settings.

*Tip:* Play/Rec/Mute can be controlled from the front panel mixer section, or from the P0– Control Surface page of the LCD screen. (See “The control surface in Sequencer mode” on page 80)

**Exclusive Solo**

Normally, Solo works in “Exclusive Solo off” mode, in which you can solo more than one track at a time (as in the example above). In contrast, “Exclusive Solo on” mode allows only one track to be soloed at a time, making it easy to switch between soloed tracks.

Use the “Exclusive Solo” page menu command to specify how the Solo function will operate.

**Exclusive Solo off:** You will be able to solo more than one track at a time. The status of a track will change each time you press its Solo On/Off button.

**Exclusive Solo on:** When you press a Solo On/Off button, only that track will be soloed.

The **SOLO** setting is not stored when you save the song.

*Tip:* You can turn Exclusive Solo on/off by holding down the ENTER switch and pressing numeric key 1 (when not in P4 or P5).

**LOCATE settings**

You can press the LOCATE switch to move to the registered location. Initially, this will move to 001:01.000.

To change the registered location, use the **Set Location** page menu command. Alternatively, you can register a location during playback by holding down the ENTER switch and pressing the LOCATE switch.

When you select a song, the “LOCATE” setting is automatically initialized to 001:01.000.

For more information, see “Set Location (for Locate Key)” on page 629 of the Parameter Guide.

**Loop playback**

When recording or playing back a song, you can individually loop the MIDI tracks that are playing.

In the P0: Play/REC– MIDI Track Loop page, check **Track Play Loop** for the MIDI tracks you want to loop, and use **Loop Start Measure** and **Loop End Measure** to specify the starting and ending measure of the region that will play back as a loop.

If **Play Intro** is checked (enabled), the measures preceding the loop will be played back as an introduction before the loop begins.

If you play back from the first measure with the settings shown in the screenshot below, the specified region of measures will repeat as follows. Note that **Play Intro** is enabled for Track 1, but disabled for Track 2.

Measure	1	2	3	4	5	6	7	8	9	10	11	12	13
Track 1	1	2	3	4	5	6	7	8	5	6	7	8	5
Track 2	9	10	9	10	9	10	9	10	9	10	9	10	9

If **Play Intro** is disabled (un-checked) for Track 1, the specified region of measures will repeat as follows.

Measure	1	2	3	4	5	6	7	8	9	10	11	12	13
Track 1	5	6	7	8	5	6	7	8	5	6	7	8	5
Track 2	9	10	9	10	9	10	9	10	9	10	9	10	9

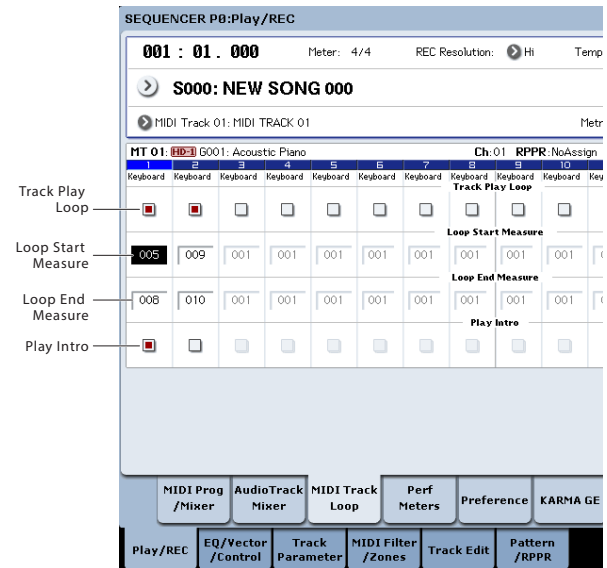

## The control surface in Sequencer mode

In Sequencer mode, you can use the nine sliders, eight knobs, and sixteen switches of the control surface to edit the sound of each track during playback, to control KARMA, or to transmit MIDI messages to external devices.

If you use the control surface to control the mixer during recording, your moves will be recorded, and will be reproduced during playback. If you want to adjust (and record) mixer settings for multiple tracks, use multi-track recording.

As explained below, you use the front panel CONTROL ASSIGN switches to select the functions that will be controlled by the sliders, knobs, and switches.

You can also view the control surface settings in the LCD screen, and edit them there. You may find it convenient to display the P0: Play/REC– Control Surface page first, so that you can watch the settings you’re making from the control surface.

### CONTROL ASSIGN

#### TIMBRE/TRACK

When TIMBRE/TRACK is selected, the control surface will edit the pan, EQ, effect send, Play/Rec/Mute status, Solo On/Off status, and volume of each MIDI track.

The LEDs at the right of the TIMBRE/TRACK switch indicate whether MIDI tracks 1–8 or 9–16 are currently selected. The sliders, knobs, and switches will control the respective set of tracks.

**KNOBS:** If you want to view and edit the Pan setting for all eight tracks at once, press the MIXER KNOBS switch to make the INDIVIDUAL PAN LED light, and use the knobs to edit the Pan settings. Conversely if you make the CHANNEL STRIP light, the knobs will control the pan, EQ, and effect sends for a single track. Use the MIX SELECT switches to select the track you want to edit, and use the knobs to control it.

**MIX PLAY/MUTE:** These switches control the Play/Rec/Mute status. Rec is available if Multi REC is turned on.

**MIX SELECT:** Press these buttons to select the current track. This current track applies to the channel strip (when MIXER KNOBS is set to CHANNEL STRIP), and to Tone Adjust.

You can also use these buttons to change the Keyboard/Rec track, so that you can switch between tracks directly from the Control Surface. To do this:

1. Go to the Control Surface tab of the P0: Play page.
2. Set CONTROL ASSIGN to TIMBRE/TRACK, using either the front-panel button or the on-screen tab.
3. Check the box on the right-hand side of the screen, labeled Link KBD/REC Trk to Ctrl Surface.

Now, you’ll be able to change the Keyboard/Rec track directly from the Control Surface.

If you press the SOLO switch, the MIX SELECT buttons will control the Solo On/Off status. The Solo behavior will depend on the Exclusive Solo setting.

*Note:* If any MIDI track, Audio track, or audio input is soloed, the SOLO switch LED will blink.

*Tip:* To turn Solo off for all tracks, hold down the RESET CONTROLS button and press the SOLO button.

*Tip:* To turn Mute off for all tracks, hold down the RESET CONTROLS button and press the TIMBRE/TRACK button.

#### AUDIO

When AUDIO is selected, the control surface will edit the pan, EQ, effect send, Play/Rec/Mute status, Solo On/Off status, and volume of the audio inputs or audio tracks.

The LEDs at the right of the AUDIO switch indicate whether audio inputs, audio tracks 1–8, or audio tracks 9–16 are currently selected. The sliders, knobs, and switches will control the respective set of inputs or tracks.

**KNOBS:** If you press the MIXER KNOBS switch to make the INDIVIDUAL PAN LED light, the knobs will control the Pan setting of the six inputs, tracks 1–8, or tracks 9–16. If the CHANNEL STRIP LED is lit and IN is selected, the knobs will control the pan and effect sends for a single input. If 1–8 or 9–16 are selected, the knobs will control the pan, EQ, and effect sends for a single track.

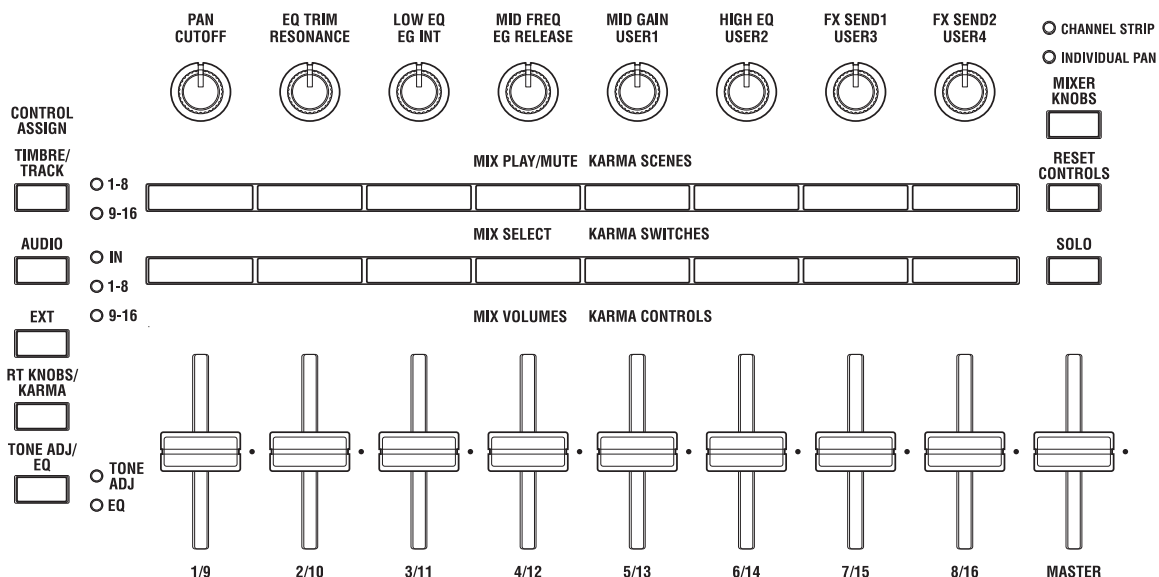

Use the MIX SELECT switches to select the input/track you want to control, and use the knobs to control them.

MIX PLAY/MUTE, MIX SELECT: These switches work in the same way as they do for TIMBRE/TRACK, as described above.

### **EXTERNAL**

When EXTERNAL is selected, the control surface is used to transmit MIDI messages to an external MIDI device. For more information, see “0–9e: External” on page 543 of the Parameter Guide.

### **RT KNOBS/KARMA**

When RT KNOBS/KARMA is selected, the sliders and switches of the control surface are used to control KARMA. For more information, see “0–9f: RT (Real Time Knobs)/KARMA” on page 545 of the Parameter Guide.

### **TONE ADJ/EQ**

When TONE ADJ/EQ (Tone Adjust) is selected, the control surface is used to temporarily adjust the program used by each MIDI track. For example while you’re creating a song, you can use this capability to adjust the sound appropriately for your song without going back to Program mode; you might soften the tone of the bass or speed-up the attack of a strings program, and make these changes happen in realtime while the song plays.

Use **Track** in the right side of the LCD to select the MIDI track you want to adjust.

For more information, see “0–9g: Tone Adjust” on page 547 of the Parameter Guide.

Note: EQ is only available in Set List mode. For more information, see “Graphic EQ” on page 127.

## MIDI recording

- You can record up to 400,000 events (e.g., notes), up to 200 songs, and up to 999 measures in each song.
- The maximum timing resolution is 1/480 parts per quarter-note.
- There are sixteen tracks for MIDI performance data, and a master track which controls the time signature and tempo.
- You can perform and record using KARMA and the Drum Track.
- You can perform and record using RPPR (Realtime Pattern Play/Recording).
- There are 718 built-in preset patterns ideal for drum tracks, and in addition you can create up to 100 user patterns for each song. These patterns can be used as performance data for a song, or with the RPPR function.

## Preparations for recording

Before you begin recording, make sure that the Global mode memory protect setting is turned off. For more information, see “Memory protect” on page 195.

### Selecting a Song

Before we can begin this example, we need to select an empty song where we can record.

1. Press the SEQ button to enter Sequencer mode.
2. Go to the first tab of the P0: Play/REC page.

The full page name is “MIDI Track Prog Select/Mixer.”

3. Press the Song Select Popup button.

The Song selection popup will appear.

4. Choose a new, empty Song from the list, and press the OK button.

#### Tip: Set Song Length

By default, new songs are 64 measures long. If you’d like to record more than 64 measures, go to the p4: Track Edit page, and use the **Set Song Length** command in the page menu. For more information, see “Set Song Length” on page 644 of the Parameter Guide.

### Track settings

Since we’re going to record a new song in this example, we will start by explaining how to assign a program to each MIDI track, and make basic settings such as volume.

For details on audio tracks, refer to “Audio recording” on page 95.

1. Assign a program to each MIDI track.

Use “Program Select” (P0: Play/REC– MIDI Track Prog Select/Mixer page) to assign a program to each MIDI track.

At this time you can press the “Category” popup and select programs by category.

You can copy various settings from Programs or Combinations, including effects, KARMA settings, Tone Adjust, and so on.

When assigning a program, you can use “Track Select” to select the track for which you are making assignments, and try playing the sound.

2. Set the pan and volume of each MIDI track.

**Pan** sets the pan of each track, and **Volume** sets the volume of each track.

3. Specify the tone generator and MIDI channel that will be played by each MIDI track.

MT 01: HD-1 G001: Acoustic Piano										Ch. 01 RPPR: NoAssic	
1	2	3	4	5	6	7	8	9	10		
Keyboard	Keyboard	Keyboard	Keyboard	Keyboard	Keyboard	Keyboard	Keyboard	Keyboard	Keyboard		
Status											
▶ BTH ▶ BTH ▶ BTH ▶ BTH ▶ BTH ▶ BTH ▶ BTH ▶ BTH ▶ BTH ▶ BTH											
MIDI Channel											
01 02 03 04 05 06 07 08 09 10											
Bank Select MSB (When Status=EX2)											
000 000 000 000 000 000 000 000 000 000											
Bank Select LSB (When Status=EX2)											
000 000 000 000 000 000 000 000 000 000											
Track Priority											
<input type="checkbox"/> <input type="checkbox"/> <input type="checkbox"/> <input type="checkbox"/> <input type="checkbox"/> <input type="checkbox"/> <input type="checkbox"/> <input type="checkbox"/> <input type="checkbox"/> <input type="checkbox"/>											

In the P2: Track Parameters– MIDI page, **Status** specifies whether each track will sound the internal tone generator or an external tone generator. **MIDI Channel** specifies the MIDI channel for each track.

Normally when using the KRONOS as a 16-timbre sound module, you will select INT or BTH.

In general, you should set **MIDI Channel** to different channels 1–16 for each track. Tracks that are sent to the same MIDI channel will sound simultaneously when either is recorded or played.

**Status INT:** During playback, the KRONOS’ internal tone generator will play the MIDI data recorded on that track. When you operate the KRONOS’ keyboard or controllers, you will be playing and controlling the track selected by “Track Select.” MIDI data will not be transmitted to an external device.

**Status EXT, EX2, BTH:** During playback, the MIDI data recorded on that track will be transmitted from MIDI OUT to play an external sound module. When you operate the KRONOS’ keyboard or controllers, MIDI data will be transmitted to play and control the external sound module selected by “Track Select.” (The MIDI channel of the external tone generator must be set to match the **MIDI Channel** of KRONOS tracks that are set to EXT, EX2 or BTH.)

If **Status** is set to BTH, both the external tone generator and internal tone generator will be sounded and controlled.

4. Adjust the effect settings.

Make settings for each effect in P8: Insert Effect and P9: Master/Total Effect.

For more information, see “Using effects in Combinations and Songs” on page 216, “Sequencer P8: Insert Effect” on page 612 of the Parameter Guide, and “Sequencer P9: Master/Total Effect” on page 624 of the Parameter Guide.

## 5. Set the tempo and time signature.

To set the tempo, you can turn the TEMPO knob or press the TAP TEMPO switch at the desired interval. Alternatively, you can select “♩ (Tempo)” in the P0: Play/REC– MIDI Track Prog Select/Mixer page (or similar page), and use the VALUE controllers to set the tempo. Set “Tempo Mode” to Manual.

Next you will set the time signature. In this example, we’ll explain how to set the time signature using the “Meter” field. Normally, you specify the time signature before recording the first track, and then begin recording.

- Press the SEQUENCER REC/WRITE switch, and set “Meter” to \*\*/\*\*.
- Press \*\*/\*\* to highlight it, and use the VALUE controllers to set the time signature.
- Press the SEQUENCER START/STOP switch to begin recording. When the pre-count has ended and Locate reaches 001:01:000, press the SEQUENCER START/STOP switch to stop recording. The time signature you specified has been recorded on the Master track.

If you press the SEQUENCER START/STOP switch during the pre-count, the time signature won’t be recorded.

## 6. Set the REC Resolution as desired.

When you record MIDI in real-time, this parameter controls timing correction, also known as “quantization.” This also applies when recording audio automation data.

This only affects newly recorded MIDI; it does not change any previously recorded tracks.

For example, let’s suppose that you recorded some eighth notes but your timing was not quite perfect, as shown in part 1 of the illustration below. If “REC Resolution” were set to ♩ when you recorded, the timing would automatically be corrected as shown in part 2 of the illustration. If “REC Resolution” is set to Hi, the notes will be recorded with the timing at which you play them.



## 7. Make other settings as necessary.

Make settings for KARMA (P7: KARMA), MIDI filtering (P3: MIDI Filter/Zone), etc.

You may also wish to use Tone Adjust to adjust the sound. (See “TONE ADJ/EQ” on page 81)

When you are finished making these settings, the basic setup is complete. You can now record as described under “Recording procedure” on page 99

## Saving your song parameter settings

All of the above settings can be saved as a Template Song. If you frequently use the same settings, this can be a real time-saver. For more information, see “Template Songs,” below.

## Template Songs

Template Songs store pretty much everything in the Song except for the MIDI and audio data itself. This includes Program selections, track parameters, effects and KARMA settings, and the Song’s name and tempo.

The factory preset Template Songs let you get up and running quickly with matched sets of sounds and effects for various styles of music. You can also create your own Template Songs with your favorite sounds and setups.

Note that Template Songs do not include the MIDI data for song tracks and patterns, audio data, or settings that govern how the musical data is played back, including **Meter**, **Metronome**, **PLAY/MUTE**, and **Track Play Loop** (including Start/End measure).

While loading a Template Song, you can also optionally load one or more Drum Track patterns.

- In the P0: Play/REC page, press the page menu button and select the Load Template Song command.

A dialog box will appear.

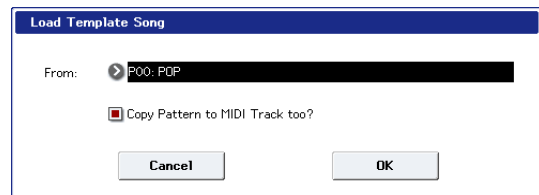

- In the From field, choose the Template Song you want to load.

- Check the “Copy Pattern to MIDI Track too?” checkbox.

When this box is checked, a dialog box for copying a pattern will automatically appear after **Load Template Song** is complete.

If this is not checked, only the selected Template Song will be loaded.

- Press the OK button to load the template song, or press the Cancel button to exit without making changes.

When you press OK, the Template Song’s settings will be copied into the current Song.



If **Copy Pattern to MIDI Track too?** was checked in step 3, the **Copy Pattern To MIDI Track** dialog box will appear.

This is the same dialog box as the one that appears for the **Copy To MIDI Track** menu command.

- In the Pattern field, select a pattern to copy.
- In the To MIDI Track field, select the track to use for the Drum Track pattern.
- In the Measure field, set the measure on which you’d like the pattern to start.

*Note:* In each of the eighteen preset Template Songs, track 1 is always assigned to a Drum Program. (In some cases, other tracks may also have Drum Programs.)

Following the names for each of the preset patterns, the musical style and the name of the most suitable Drum Programs are partially displayed. (Refer to the VNL for a complete list of Drum Programs.)

By loading a drum track and the corresponding preset pattern, you can instantly set up a Drum Track to match the Template Song.

### 8. To load the Drum pattern, press the OK button.

After the pattern is loaded, the **Measure** will count up automatically. You can then copy another pattern if desired. For instance, you can use different patterns one after the other to build up a song, with different patterns for verse, chorus, and bridge.

After you've finished adding patterns, press the **Exit** button, and you're done!

## Saving your own Template Songs

You can also save your own Template Songs:

1. Set up a Song to your taste, including Programs, effects, KARMA settings, the Song name, and so on.
2. In the P0: Play/REC page, press the page menu button and select the Save Template Song command.
3. In the To field, select one of the 16 user Template Song locations, U00...15.
4. Press OK to save the Template Song.

For more information, see "Save Template Song" on page 628 of the Parameter Guide

## Recording MIDI in real-time

When you've finished with "Preparations for recording," as described above, you can start recording!

Real-time recording lets you record your performance on the KRONOS, including the notes that you play, joystick and knob movements, and so on. This is in contrast to step recording, which is described in a later section.

The default is to record onto a single track at a time. As an alternative, multitrack recording allows you to simultaneously record multiple channels of data onto multiple tracks. This is handy for use when recording RPPR, KARMA, or the Drum Track, or for recording the output of an external sequencer in a single pass.

## Overwrite

With this method, the musical data previously recorded on a track is overwritten by the newly recorded data. When you perform overwrite recording on a previously-recorded track, its musical data will be deleted and replaced by the newly recorded data.

Normally you will use this method to record, and then modify the results by using other types of realtime recording or MIDI event editing.

1. Use "Track Select" to select the track that you want to record.
2. Set the Recording Setup to Overwrite.
3. In "Location," specify the location at which you wish to begin recording.
4. Press the SEQUENCER REC/WRITE switch, and then press the SEQUENCER START/STOP switch.

## Recording setup

In P0: Play/REC—Preference page **Recording Setup**, select the realtime recording method you want to use.

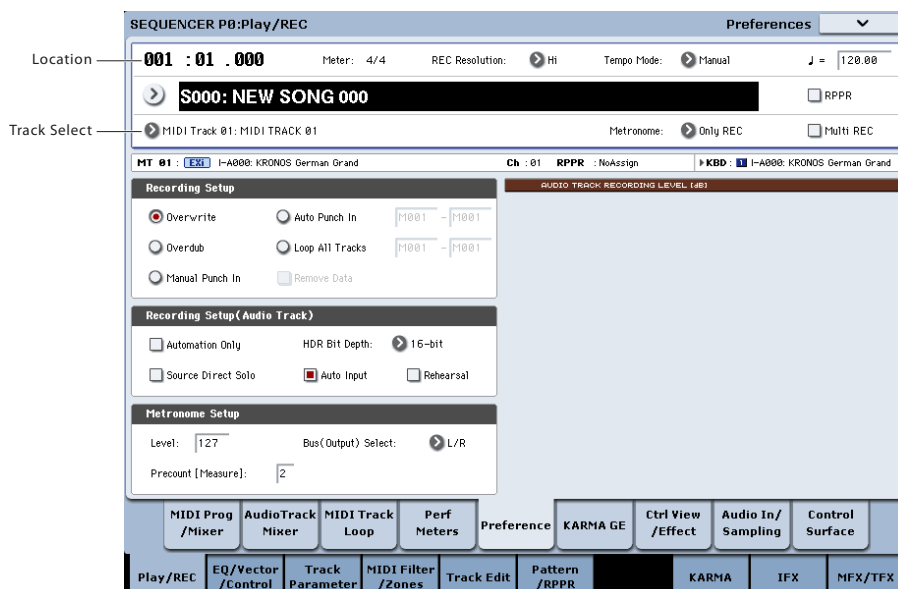
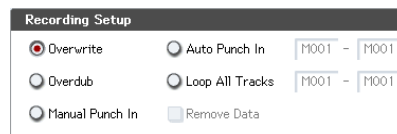



If the **Metronome Setup** is still set to the default settings, the metronome will sound for a two-measure pre-count, and then recording will begin.

Play the keyboard and move controllers such as the joystick to record your performance.

#### 5. When you finish playing, press the SEQUENCER START/STOP switch.

Recording will end, and the location will return to the point at which you begin recording.

If you press the PAUSE switch instead of the SEQUENCER START/STOP switch, recording will pause. When you press the PAUSE switch once again, recording will resume. When you are finished, press the SEQUENCER START/STOP switch to stop recording.

### Overdub

With this method, the newly recorded musical data is added to the existing data.

When you perform overdub recording on a previously-recorded track, the newly recorded data will be added to the previously-recorded data.

It is best to select this mode if you will be recording additional control data, recording a drum pattern, or recording the tempo in the master track. With this mode, data can be added without erasing the existing performance data.

1. Use “Track Select” to select the track that you want to record.
2. Set the Recording Setup to Overdub.

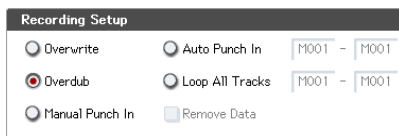

3. For the rest of the procedure, refer to steps 3–5 of “Overwrite.”

### Manual punch-in

While the song is playing, you can press the SEQUENCER REC/WRITE switch or a connected pedal switch at the desired location to start or stop recording. With this method, the musical data previously on the track is overwritten by the newly recorded data.

1. Use “Track Select” to select the track that you want to record.
2. Set the Recording Setup to Manual Punch In.

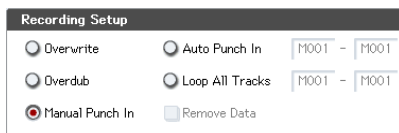

3. In “Location,” specify a location several measures earlier than the point at which you wish to begin recording.
4. Press the SEQUENCER START/STOP switch.  
Playback will begin.
5. At the point at which you wish to begin recording, press the SEQUENCER REC/WRITE switch.

Recording will begin. Play the keyboard and operate controllers such as the joystick to record your performance.

#### 6. When you finish recording, press the SEQUENCER REC/WRITE switch.

Recording will end (playback will continue).

*Note:* Instead of pressing the SEQUENCER REC/WRITE switch in steps 5 and 6, you can use a foot switch connected to the ASSIGNABLE SWITCH jack.

Set the Global P2: Controllers/Scales page “Foot Switch Assign” to Song Punch In/Out.

#### 7. Press the SEQUENCER START/STOP switch.

Playback will stop, and you will return to the location that you specified in step 3.

### Auto punch-in

First you must specify the area that will be re-recorded. Then recording will occur automatically at the specified area. With this method, the musical data previously on the track is overwritten by the newly recorded data.

1. Use “Track Select” to select the track that you want to record.
2. Set the Recording Setup to Auto Punch In.

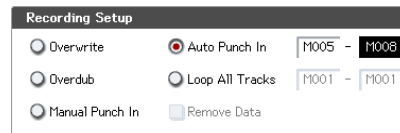

3. In “M (Auto Punch In Start Measure),” “M (Auto Punch In End Measure)” specify the area that you wish to record.

For example if you specify M005–M008, recording will occur only from measure 5 to measure 8.

4. In “Location,” specify a location several measures earlier than the point at which you wish to begin recording.
5. Press the SEQUENCER REC/WRITE switch, and then press the SEQUENCER START/STOP switch.  
Playback will begin.

When you reach the starting location you specified in step 3, recording will begin. Play the keyboard and operate controllers such as the joystick to record your performance. When you reach the ending location you specified in step 3, recording will end. (Playback will continue.)

#### 6. Press the SEQUENCER START/STOP switch.

Playback will stop, and you will return to the location you specified in step 4.

### Loop All Tracks

This method lets you continue recording as you add musical data.

The specified region can be recorded repeatedly. This is ideal when recording drum phrases, etc.

1. Use “Track Select” to select the track that you want to record.
2. Set the Recording Setup to Loop All Tracks.

If **Multi REC** is checked, it will not be possible to select Loop All Tracks.

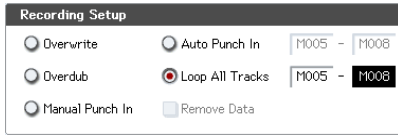

3. In “M (Loop Start Measure), “M (Loop End Measure)” specify the area that you wish to record.  
For example if you specify M004–M008, recording will occur repeatedly (as a loop) from measure 4 to measure 8.
4. In “Location,” specify a location several measures earlier than the point at which you wish to begin recording.
5. Press the SEQUENCER REC/WRITE switch, and then press the SEQUENCER START/STOP switch.

Playback will begin. When you reach the starting location you specified in step 3, recording will begin. Play the keyboard and operate controllers such as the joystick to record your performance.

When you reach the ending location you specified in step 3, you will return to the starting location, and continue recording.

The musical data that is loop-recorded will be added to the previously-recorded data.

6. You can also erase specific data even while you continue loop recording.  
If you press the SEQUENCER REC/WRITE switch during loop recording, all musical will be removed from the currently selected track as long as you continue pressing the switch.  
By checking the “Remove Data” check box you can erase only the specified data. During loop recording, press the note that you wish to delete, and only the data of that note number will be deleted from the keyboard as long as you continue pressing that note.  
Similarly, bender data will be deleted as long as you tilt the joystick in the X (horizontal) direction, and after touch data will be deleted as long as you apply pressure to the keyboard.  
When you are once again ready to record musical data, uncheck the “Remove Data” check box.

7. Press the SEQUENCER START/STOP switch.  
Playback will end, and you will return to the recording start location that you specified in step 4.  
If Loop All Tracks is selected, normal playback will be looped as well.

### Multi (multitrack recording)

Multitrack recording allows you to simultaneously record onto multiple tracks, each with a different channel.

1. In the upper right of the LCD screen, check “Multi REC.”
2. Make the desired Recording Setup settings.  
You can record using Overwrite, Overdub, Manual Punch In, or Auto Punch In.

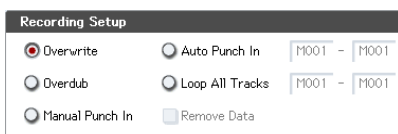

3. Use “Location” to specify the measure at which recording will begin.
4. Press the SEQUENCER REC/WRITE switch.
5. For the track you want to record, press Play/Rec/Mute to make it indicate Rec.
6. Press the SEQUENCER START/STOP switch.  
With the default settings for Metronome Setup, the metronome will sound for a two-measure pre-count, and then recording will begin. Now you can perform on the keyboard and controllers, and use the KARMA or RPPR functions if desired.
7. Press the SEQUENCER START/STOP switch.  
Playback will stop, and you will return to the location specified in step 4.

### An example of realtime recording

In this example, we’ll assign a drum program to MIDI Track 01 and create the following one-measure drum phrase.



1. Create a new song, and specify a drum program for MIDI Track 01. Use “Track Select” to select MIDI Track 01, and verify that you hear a drum program.
2. Go to the P0: Play/REC– Preference page. In Recording Setup, specify “Loop All Tracks” and set it to M001-M001.  
For more information, see “Loop All Tracks” on page 85. With this setting, measure 1 will be recorded repeatedly. The newly recorded data will be added at each pass.
3. Set “REC Resolution” to ♩.
4. Press the SEQUENCE REC/WRITE switch, and then the START/STOP switch.  
The metronome will sound a two-measure count-down, and then recording will begin.
5. As shown in the musical example printed above, start by playing the C3 note of the keyboard to record the bass drum for one measure.
6. Next, play the E3 note of the keyboard to record the snare for one measure, and then the F#3 note to record the hi-hat.
7. Press the SEQUENCER START/STOP switch to stop recording.
8. Play back the result, and listen to the drum performance you recorded.  
Press the SEQUENCER START/STOP switch. When you’ve finished listening, press the START/STOP switch once again to stop playback.
9. If you’re not satisfied with the result, press the COMPARE switch to return to the state prior to recording, and then re-record from step 4.

*Note:* When you’re finished recording, change the Recording Setup back to the normally-used Overwrite (P0: Play/REC– Preference page).

In addition, access the P0: Play/REC– MIDI Track Loop page, check “Track Play Loop” for MIDI Track 01, and set the “Loop Start Measure” and “Loop End Measure” to



001. When you play back, MIDI track 01 will repeatedly play the first measure.

## MIDI step recording

Step recording is the recording method in which you specify the duration and strength of each note, and use the keyboard to specify the pitch of each MIDI note. You can use the Rest button and Tie button of the dialog box to input rests and ties.

Step recording is useful when you want to create mechanically precise beats, or when you need to record a phrase that would be difficult to play by hand “in realtime,” or when you find it difficult to play extremely complicated or rapid passages.

### An example of step recording

In this example, we’ll assign a bass program to MIDI Track 02 and step-record the following two-measure bass phrase.



1. Specify a bass program for MIDI Track 02. Use “Track Select” to select MIDI Track 02, and verify that you hear a bass program.
2. Go to the P4: Track Edit– Track Edit page.
3. Set “From Measure” to 001.

With this setting, step recording will begin from measure 1.



4. Press the page menu button, and press page menu command “MIDI Step Recording.”

A dialog box will appear.

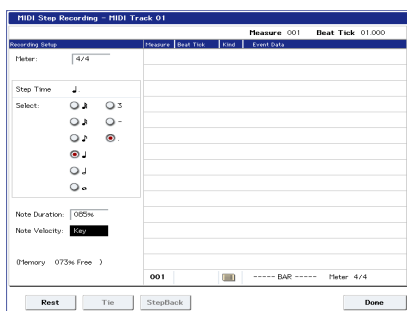

5. In “Step Time,” use “Select” to specify the basic timing value at which you will input notes and rests.

Input the first C3 note as ♩ (a dotted eighth note).

Use the radio button at the left to select ♩.

You can choose from the range of ♩ (a whole note)– ♩ (a 32nd note).

Input a dotted note by selecting “.” with the radio buttons at right.

You can specify “3” to enter a triplet. If you want to use the unmodified length of the note that’s selected at the left, choose “-”.

“Note Duration” indicates the length that the note itself will sound. Smaller values will produce a staccato note, and larger values will produce a legato note. For this example, leave this setting unchanged.

“Note Velocity” is the velocity (playing strength), and larger values will produce a louder volume. Set this to Key.

If you select Key for this parameter, the velocity with which you actually play the keyboard will be input.

6. On the keyboard, press and then release the first C3 note that you want to input.

The data you input will appear in the LCD screen as numerical values. In the upper right, Measure 001 Beat Tick 01.000 will change to Measure 001 Beat Tick 01.360. The next note you input will be placed at this location.

7. Input the remaining notes as described in steps 5 and 6. (You’ve already input the first C3 note.)

In addition to the methods described in steps 5 and 6, you can also use the following input methods.

- To input a rest, press the Rest button. This will input a rest of the “Step Time” value.
- To modify the length of a note, you can modify the “Step time” value before you input the note. However if you want to extend the length (tie) of the note, press the Tie button. At this time, the previously-input note will be extended by the “Step time” length.
- To delete a note or rest that you input, press the Step Back button. The previously-input note will be deleted.
- To input a chord, simultaneously press the notes of the desired chord. Even if you do not press them simultaneously, notes that are pressed before you fully remove your hand from all keys on the keyboard will be input at the same location.
- If you want to verify the pitch of the note that you will input next, press the PAUSE switch. In this state, playing a key will produce a sound, but will not input a note. Press the PAUSE switch once again to cancel the record-pause state, and resume inputting notes.

Note	Step Time: Select	Step Time: . 3 -	Key, Button	Measure/ Beat Tick
C3	♩	.	C3 key	001 / 01.000
G3	♩	-	G3 key	001 / 01.360
7	♩	-	Rest button	001 / 02.000

Note	Step Time: Select	Step Time: .3 -	Key, Button	Measure/ Beat Tick
C4		-	C4 key	001 / 02.240
		-	Rest button	001 / 03.000
C4		-	C4 key	001 / 03.120
D3		-	D3 key	001 / 03.240
Eb3		-	Eb3 key	001 / 04.000
E3		-	E3 key	001 / 04.240
F3		-	F3 key	002 / 01.000
		-	Rest button	002 / 01.120
C3		-	C3 key	002 / 01.360
		-	Rest button	002 / 02.000
F2		-	F2 key	002 / 02.240
Tie		-	Tie button	002 / 03.000
F2		-	F2 key	002 / 03.240
		-	Rest button	002 / 03.360
A2		-	A2 key	002 / 04.000
A3		-	A3 key	002 / 04.240
		-	Rest button	002 / 04.360

**8. When you are finished recording, press the Done button.**

Press the SEQUENCER START/STOP switch to play back.

Go to the P0: Play/REC– MIDI Track Loop page, check **Track Play Loop** for MIDI Track 02, set **Loop Start Measure** to 001, and **Loop End Measure** to 002. MIDI track 02 will play measures 1–2 repeatedly.

**9. If you're not satisfied with the result, press the COMPARE switch to return to the state prior to recording, and then re-record from step 4.**

When you begin step recording, all data in the MIDI track that follows the measure where you began recording will be erased. You need to be aware of this if you begin step recording from a measure mid-way through the song.

If you want to copy data into a measure that already contains data, perform step recording in an empty MIDI track, and use the **Move Measure** or **Copy Measure** menu commands. For more information, see “Copy Measure” on page 649 of the Parameter Guide, and “Move Measure” on page 649 of the Parameter Guide.

If you want to edit or add to the recorded data, you can use the **MIDI Event Edit** function. For more information, see “Event Edit” on page 657 of the Parameter Guide.

## Recording the sound of a Combination or Program

Here's how you can easily copy the settings of a Combination or Program, and then record using that sound.

When you're performing in Program or Combination mode, you can use the Auto Song Setup function to automatically the current Program or Combination into a song. Alternatively, you can use the Sequencer mode's **Copy From Combi** and **Copy from Program** menu commands.

### Auto Song Setup

You can use Auto Song Setup with both Programs and Combinations. In this example, we'll use a Combination.

**1. Save any edits to the Combination.**

If you've made any edits—even simple things like changing pan and volume for the Timbres— must save the new settings using **Update Combination** or **Write Combination** before proceeding.

**2. Hold down the ENTER switch and press the SEQUENCER REC/WRITE switch.**

The **Setup to Record** dialog box will appear.

**3. Press the OK button to perform the Auto Song Setup.**

The KRONOS will automatically switch to Sequencer mode, and the Combination's settings will be applied to the first unused song.

**4. You will automatically enter record-ready mode, and the metronome will begin sounding according to the settings in P0: Play/REC– Preference page.**

For more information, see “0–5d: Metronome Setup” on page 532 of the Parameter Guide.

**5. Press the SEQUENCER START/STOP switch, and real-time recording will begin.**

When you're finished recording, press the START/STOP switch once again.

### Auto Song Setup and Combinations: Details

With Combinations, Auto Song Setup is essentially a shortcut for using the **Copy From Combi** menu command with the following settings:

**IFXs-All, MFXs and TFXs checked**

**Multi REC checked**

For more information, see “Copy from Combi” on page 629 of the Parameter Guide

### Auto Song Setup and Programs: Details

With Programs, Auto Song Setup is essentially a shortcut for using the **Copy From Program** menu command with the following settings:

**IFXs-All, MFXs and TFXs checked**

**with KARMA checked**

**To set to MIDI Track 01**

**KARMA Module set to A**

**With Drum Track set to Track 10**

Additionally, several Song parameters are changed:

**Multi REC checked**

MIDI Tracks 1 and 10 are set to **REC**

For more information, see “Copy From Program” on page 629 of the Parameter Guide

## Setup in Sequencer mode (Copy From Combination and Copy From Program)

In Sequencer mode, you can use the “Copy From Combi” and “Copy From Program” page menu commands to set up a Song based on a Combination or Program. In this example, we’ll explain how to set up a song based on a combination.

*Note:* Make sure that the global MIDI channel (Global P1: MIDI– MIDI page, **MIDI Channel**) is set to 01.

1. **Select a new, empty song.**
2. **Select the page menu command “Copy From Combi.”**

A dialog box will appear.

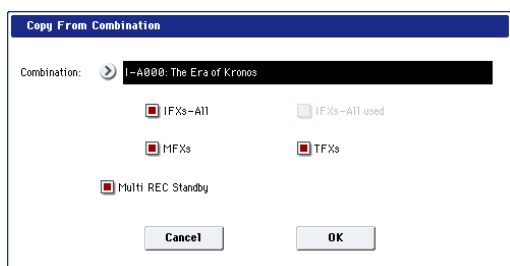

Select the program or combination that you want to copy (i.e., the copy source).

We will copy the effect settings of the combination as well, so check the **IFXs-All**, **MFXs** and **TFXs** check boxes.

Check **Multi REC Standby**. The **Status** will be automatically set to REC for the MIDI tracks needed to record that combination.

Press the OK button to execute the copy.

Notice that when you execute this command, the **Play/Rec/Mute** setting of each track will be set automatically. The **Multi REC** check box will be checked.

3. **Begin recording.**

Press the LOCATE switch to set the location to 001:01.000.

Press the SEQUENCER REC/WRITE switch, and then press the SEQUENCER START/STOP switch.

*Note:* If you play the keyboard during the pre-count before recording, KARMA and the Drum Track will start playing the moment recording begins.

4. **Record your performance.**
5. **When you are finished performing, press the SEQUENCER START/STOP switch.**

If you made a mistake or want to re-record, you can use the Compare function (press the COMPARE switch) to re-record as many times as you want. (The **Multi REC** check box will be unchecked when you use Compare, so you will need to check it again.)

## Recording multiple MIDI tracks from an external sequencer

1. Make sure that the MIDI OUT of your external sequencer is connected to the MIDI IN of the KRONOS.

If it is not connected, turn off the power, make the connection, and then turn the power on.

For more information, see “MIDI applications” on page 1131 of the Parameter Guide.

2. In the Global P1: MIDI– MIDI page, set MIDI Clock to External MIDI. With this setting, the KRONOS will synchronize to MIDI clock messages from your external sequencer.

Make sure that Receive Ext. Realtime Commands is checked.

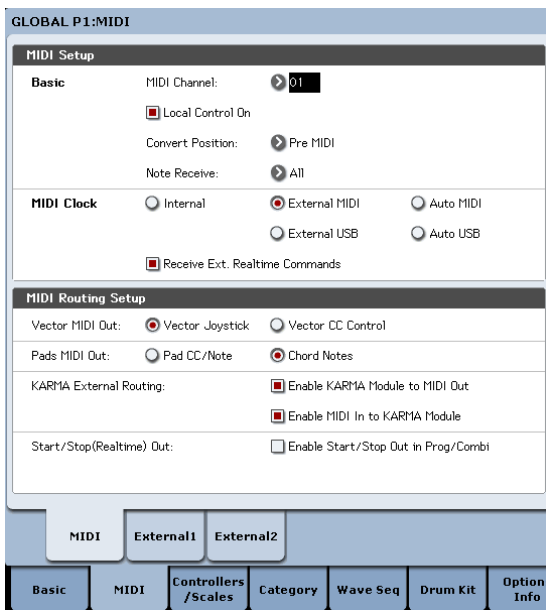

3. Create a new song in Sequencer mode, and in the P0: Play/REC– Preference page, check the Multi REC check box. Set Recording Setup to Overwrite.

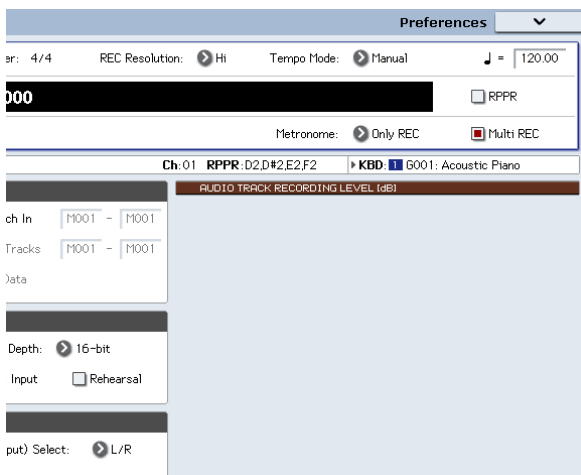

4. Press Play/Rec/Mute to select “REC” for the tracks you want to record.

For the tracks you don’t want to record, select Play or Mute.

*Tip:* You can also control the Play/Rec/Mute setting from the front panel mixer section, or from the P0– Control

Surface page of the LCD screen. (See “The control surface in Sequencer mode” on page 80.)

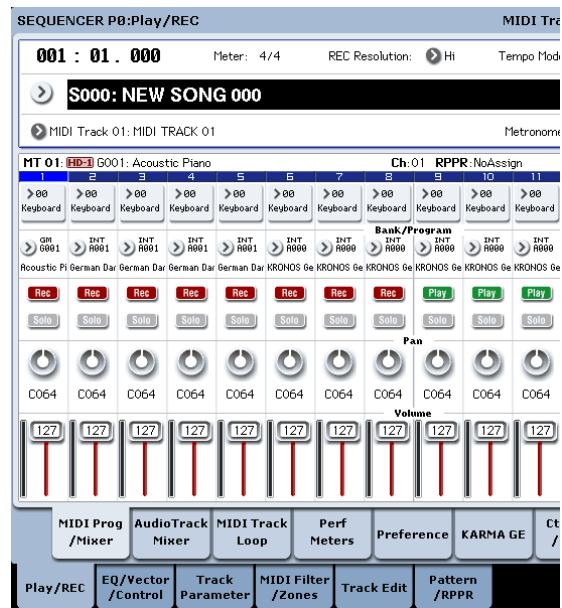

5. In the P2: Track Parameters– MIDI page, use MIDI Channel to specify the MIDI channel of each track.

Set the MIDI channel of each KRONOS track to match the MIDI channel of each external sequencer track. Data of the matching channel will be recorded on each KRONOS track.

Make sure that Status is set to INT or BTH.

6. Press the LOCATE switch to set the location to 001:01.000.
7. Press the SEQUENCER REC/WRITE switch to enter record-standby mode.
8. Start your external sequencer.

The KRONOS’ sequencer will automatically begin recording when it receives the MIDI Start message transmitted by your external sequencer.

9. When playback has ended, stop your external sequencer.

The KRONOS’ sequencer will automatically stop recording when it receives the MIDI Stop message transmitted by the external sequencer. You can also stop recording by pressing the SEQUENCER START/STOP switch of the KRONOS.

After this, you can play back the newly recorded sequence:

10. In the Global P1: MIDI page, set MIDI Clock to Internal.
11. Set “Tempo Mode” to Auto.
12. Press the SEQUENCER START/STOP switch to play back.

*Note:* If the correct sounds are not selected when you start playing back, you may be able to solve the problem by using the page menu command “MIDI Event Edit” (P4: Track Edit) to re-specify the Program Change data.

## Recording System Exclusive events

Exclusive messages received from an external MIDI device or the parameter changes produced when you edit a MIDI track parameter, audio track parameter or effect parameter can be realtime-recorded on any MIDI track.

During playback, the exclusive messages you recorded will control the track parameters and effect parameters of the song, and can be sent to external MIDI devices.

*Note:* You can use the page menu command “Put Effect Setting to Track” to insert an exclusive event containing the parameter settings for an insert effect, master effect or total effect into the desired location of a track, so that these settings will automatically switch during playback.

- GM, XG, and GS exclusive messages can be recorded on a track, but the KRONOS’s tone generator will not respond to these messages.

## Recording internal parameter changes

You can use SysEx for automation of internal KRONOS effects and Program parameters.

As an example, let’s record a short phrase on track 1, add an insert effect, and then record parameter changes for that effect on an unused track.

*Note:* In order to record system exclusive messages, make sure that the Global P1: MIDI– MIDI setting “Enable Exclusive” is checked.

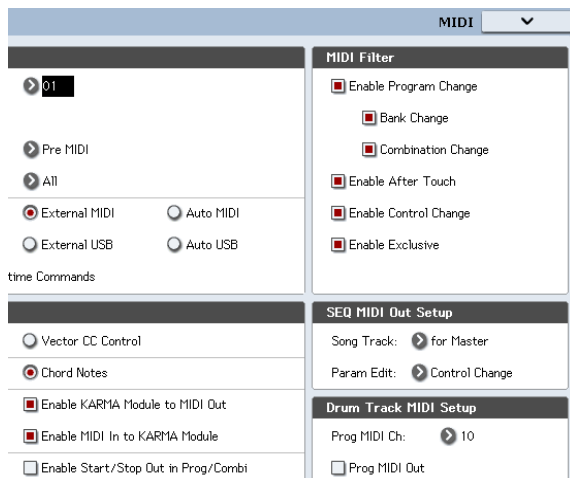

### 1. Select the desired program for MIDI track 1, and route it to IFX1. Then record a phrase of about sixteen measures.

- In the P0: Play/REC– MIDI Track Prog Select/ Mixer page, use “Program Select” to select the desired program for MIDI Track 01.
- In the P8: Insert Effect– MIDI Routing1 page, route the MIDI Track 01 **Bus Select (IFX/Indiv. Out Assign)** to IFX1. Then in the P8: Insert Effect– Insert FX page, select the desired effect for IFX1.

### 2. Select MIDI Track 01 in “Track Select,” and record parameter changes as desired.

*Note:* For this example, select an empty track. If you want to record onto a MIDI track that already contains data, set the P0:Play/REC– Preference page **Recording Setup** to “Overdub,” as described on page 85.

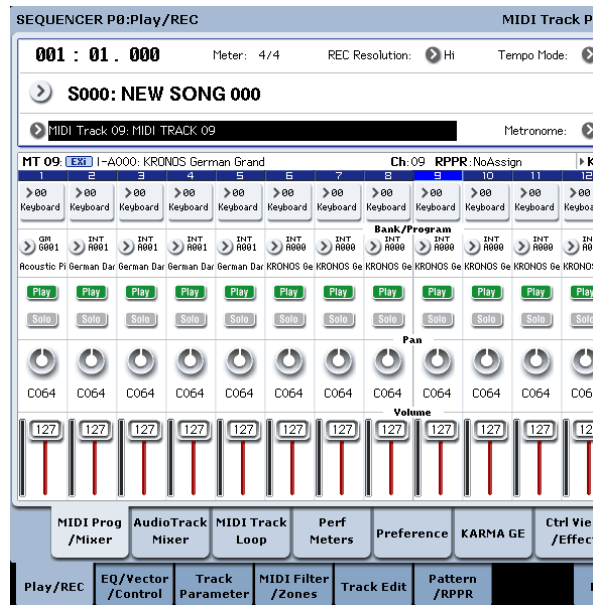

- Select MIDI Track 09 in “Track Select.” Then press the SEQUENCER REC/WRITE switch and then the START/STOP switch, and begin recording.
- At the appropriate time while recording, adjust the parameter(s) that you want to realtime-record.

Select another effect for IFX1 in the P8: Insert Effect– Insert FX page, and edit the effect parameter values, or use the P0: Play/REC– Control Surface page Tone Adjust controls to edit the sound in realtime.

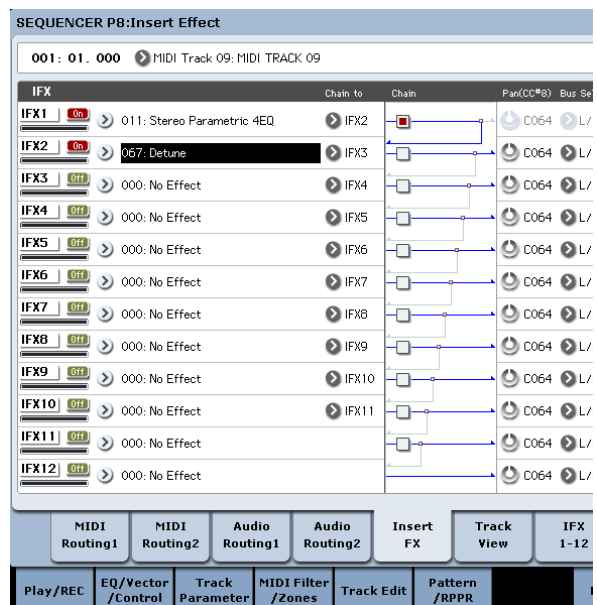

*Note:* For details on the effects parameters that you can record in real-time, please see “System Exclusive events supported in Sequencer mode” on page 663 of the Parameter Guide.

### 3. Stop recording.



*Note:* Exclusive messages are always recorded on the current track selected by “Track Select.” In this example, they are recorded on MIDI track 9.

*Note:* In the MIDI event edit screen you can view the recorded exclusive events and their location. Exclusive events are displayed as “EXCL”.

To view these events, go to the P4: Track Edit– Track Edit page, and select the page menu command “MIDI Event Edit.” Then in the Set Event Filters dialog box, check Exclusive and press the OK button.

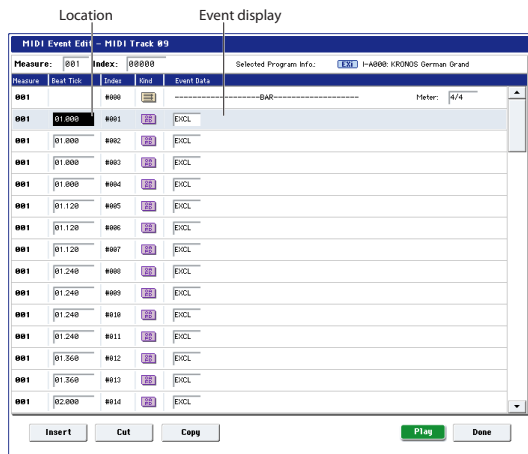

Exclusive events cannot be changed to a different type of event. Nor can other events be changed into exclusive events.

- If you go to the page (e.g., P8: Insert Effect) that shows the parameters you adjusted in realtime, you can watch the recorded changes be reproduced while the song plays back.

### Exclusive messages that can be recorded in real-time

The following exclusive messages can be recorded in real-time:

- Exclusive program messages received from an external MIDI device
- Parameter changes in Sequencer mode (see “System Exclusive events supported in Sequencer mode” on page 663 of the Parameter Guide)
- Master Volume universal exclusive messages assigned to the foot pedal or a knob

## Recording patterns

### Recording and editing patterns

You can record patterns in either of two ways; realtime recording or step recording. However, pattern realtime recording differs from song realtime recording in that you can use only Loop type recording.

You can edit patterns by using Event Edit operations to modify the recorded data or insert new data. You can also use the **Get From MIDI Track** page menu command to convert a desired region of performance data from a MIDI track into a pattern. Conversely, you can use the **Put to MIDI Track** or **Copy to MIDI Track** page menu commands to place or copy the performance data from a pattern into a MIDI track.

You can also use your patterns with the Drum Track, via the **Convert to Drum Track Pattern** menu command on P5: Pattern/RPPR.

### Recording patterns in real-time

Here’s how you can use realtime recording to create a pattern. User patterns can be accessed by the RPPR function in the same way as preset patterns, and can be copied to or placed in a song. Playback data from a track can also be copied to a pattern.

When realtime-recording a pattern, a pattern of the specified number of measures will playback repeatedly, allowing you to continue adding musical data to it.

- Create a new song, and as described in “Preparations for recording” on page 82, set the track to the program that will be used by the pattern.
- Go to the P5: Pattern/RPPR– Pattern Edit page (See the diagram below).

- Use “Track Select” to select the track that you will use to record the pattern.

The pattern will sound with the program and other settings of the selected track.

- Set “Pattern (Pattern Bank)” to User, and set “Pattern Select” to U00.

User patterns U00–U99 can be created for each song.

- Select the page menu command “Pattern Parameter”.

A dialog box will appear.

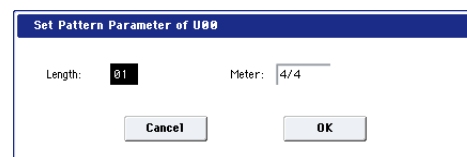

- Set the number of measures in the pattern to a “Length” of 04 (four measures), and set “Meter” to a time signature of 4/4. Press the OK button.
- As necessary, set “REC Resolution” to apply realtime quantization.

- Begin realtime recording.

You can record in the same way as you did when recording tracks with Loop All Tracks. (See “Loop All Tracks” on page 85.)

Press the SEQUENCER REC/WRITE switch, and then press the SEQUENCER START/STOP switch.

After the pre-count, pattern recording will begin. Play the keyboard and operate the joystick and other controllers to record your performance.

When you reach the end of the pattern, the sequencer will return to the beginning of the pattern and continue

recording. If you continue recording, the newly recorded data will be added to the previously-recorded data.

**9. If you want to delete specific data while you continue pattern recording, you can press the SEQUENCER REC/WRITE switch or check the “Remove Data” check box.**

For details refer to step 6 of “Loop All Tracks” on page 85.

**10. Press the SEQUENCER START/STOP switch to stop recording.**

If you made a mistake or decide to re-record, press the SEQUENCER START/STOP switch to stop recording, and press the COMPARE switch. Then begin the pattern recording procedure again as in step 8.

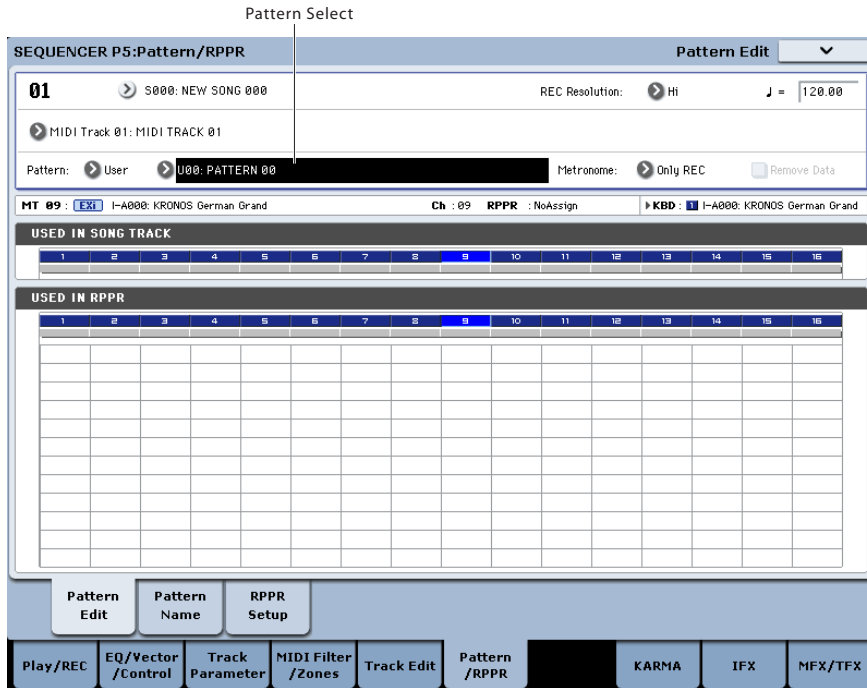

**Control data in pattern recording**

To record control data in a pattern, you should restore the control data to its normal value within the pattern. If you fail to restore the normal value, unnecessary control data may remain in a “stuck” position when you place the pattern in a song or use the RPPR function to play the pattern. However, the following control data will be automatically reset to the following values when the song or RPPR function finishes playing the pattern, or when playback is halted.

Controller	Reset value
Modulation 1 (CC#01)	00 (zero)
Modulation 2 (CC#02)	00 (zero)
Expression (CC#11)	127 (max)
Ribbon controller (CC#16)	64 (center)
Damper switch (CC#64)	00 (zero)
Sostenuto switch (CC#66)	00 (zero)
Soft switch (CC#67)	00 (zero)
EG sustain level (CC#70)	64 (center)
Resonance level (CC#71)	64 (center)
EG release time (CC#72)	64 (center)
EG attack time (CC#73)	64 (center)
Low pass filter cutoff (CC#74)	64 (center)
EG decay time (CC#75)	64 (center)
LFO1 speed (CC#76)	64 (center)

Controller	Reset value
LFO1 depth (pitch) (CC#77)	64 (center)
LFO1 delay (CC#78)	64 (center)
Filter EG intensity (CC#79)	64 (center)
SW1 modulation (CC#80)	00 (zero)
SW2 modulation (CC#81)	00 (zero)
Channel after touch	00 (zero)
Pitch bender	00 (zero)

**Using KARMA for pattern recording**

If KARMA is set to operate for the track that is selected for “Track Select,” and record the performance of KARMA into the pattern.

---

## Other ways to record

---

### Multi-track recording with KARMA and the Drum Track

You can record multi-track performances generated by KARMA and/or the Drum Track. For more information, see “Using KARMA in Sequencer mode” on page 244.

---

### Multi-track recording with RPPR

You can record multi-track performances generated by RPPR. For more information, see “Using RPPR (Realtime Pattern Play/Record)” on page 112.

---

### Using the control surface to record changes in the pan, EQ, volume, or Tone Adjust parameters of a MIDI track

During realtime recording, you can use the control surface to control the pan, EQ, volume, or Tone Adjust parameters, and record these changes so that they will be reproduced during playback.

If you will be adjusting more than one track simultaneously, you’ll need to use multi-track recording.

*Note:* Changes you make using the control surface are transmitted as control changes or system exclusive messages. In order to record these changes, the Global P1: MIDI– MIDI **Enable Control Change** and **Enable Exclusive** items must be checked. Move to Global mode and make sure that these items are checked.



# Audio recording

## Audio recording overview

- There are sixteen audio tracks. They allow 16- or 24-bit linear PCM recording with a maximum time of 80 minutes.
- Automation data (volume, pan, EQ, send 1/2) can be recorded for each track.
- Up to sixteen tracks can be played back simultaneously, and up to four tracks can be recorded simultaneously.
- The Stereo Pair function lets you assign two tracks as a pair for recording, control, and editing.
- You can choose from a broad range of internal buses as the recording source; Audio Input 1–2, S/P DIF, USB, REC Bus 1–4, the main L/R outputs, or individual outputs 1–4 (yes, you can directly record from the outputs, all in the digital domain). You can also route the signal very flexibly, for example by inserting effects into external audio sources and recording the result.
- When you record, an audio event and region data are created and assigned to the track. The region data contains a link to the WAVE file (audio data) that’s recorded on the disk. You can edit in a variety of ways, for example by changing the location of the audio event, or by editing/replacing the region data or WAVE file.
- Auto or manual punch-in/out are provided.
- The Rehearsal function lets you practice a punch-in/out without actually recording.
- You can use the control surface mixer to adjust the pan and volume etc. of the audio tracks, and record these operations as automation events so that the pan and volume changes will be reproduced during playback.

⚠ When recording audio tracks, the **MIDI Clock** must be set to Internal. For more information, see “MIDI Clock (MIDI Clock Source)” on page 773 of the Parameter Guide.

## Audio events and regions in an audio track

When you record on an audio track, the actual audio data is recorded directly on the internal drive as a WAVE file. At this time, a “region” is also created; this contains information specifying what portion of that WAVE file is to be actually played back. In addition, an “audio event” which assigns that region is created; this specifies the location in the song at which the audio will play.

When playback reaches a point in the song where an audio event is located, the WAVE file on the disk will be played as specified by the audio event and the region. In other words, the audio will not play if either the audio event, the region, or the WAVE file are missing.

⚠ Please note that audio events and regions can be deleted by audio event editing or region editing, and can also be easily lost if you turn off the power before saving to the disk. If only the WAVE file is left on the disk, this will occupy disk capacity for no purpose; we recommend that you execute “Delete Unused WAV Files” to free up any such wasted space.

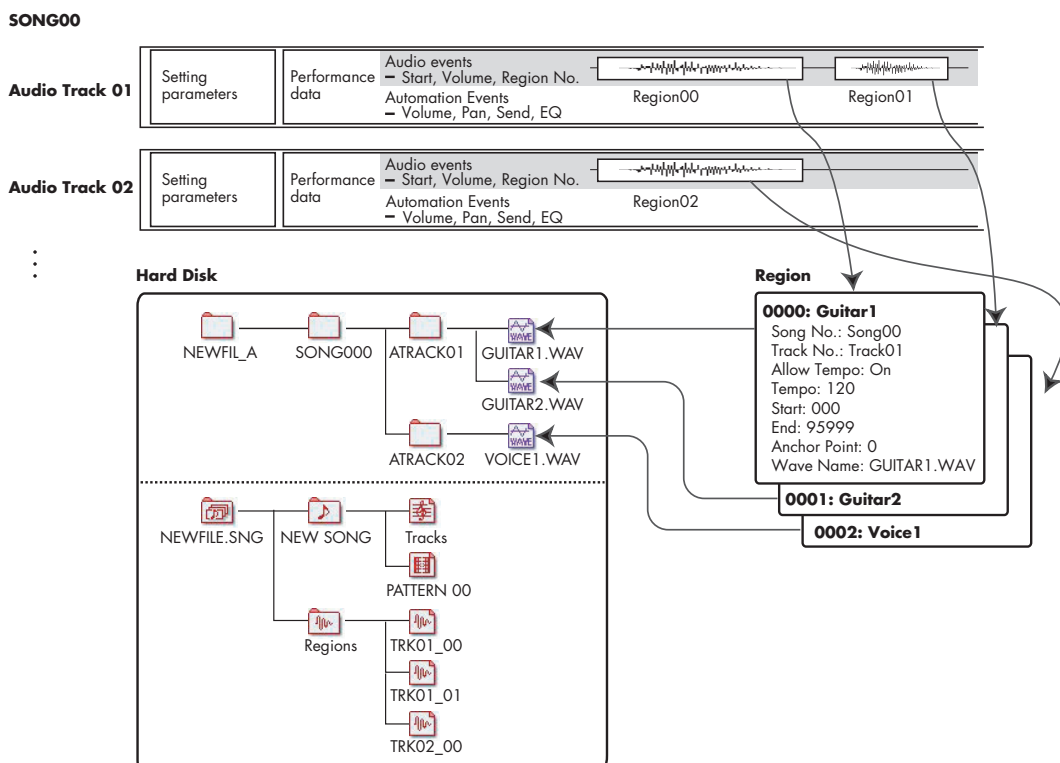

## How audio data is stored on the disk

When you save Songs to disk, they're stored in an .SNG file. This .SNG file contains all of the data from Sequencer mode, including all of the Songs in memory, except for the related audio files.

When you save an .SNG file, its related audio files are stored in a separate directory. This directory is created automatically, within the same directory as the .SNG file. (It's also created if you load a pre-existing .SNG file which doesn't have a matching audio directory.) The directory's name consists of the .SNG file name followed by "\_A" (for "Audio").

For instance, if the .SNG file is named WAMOZART.SNG, its audio directory will be named WAMOZART\_A.

This main directory contains sub-directories for each song, named SONG000, SONG001, etc. These in turn contain sub-directories for each audio track, named ATRACK01, ATRACK02, and so on. Within each of the track sub-directories, each individual audio take is stored as a WAVE file.

## Move or re-name audio and .SNG files together

If you move or re-name an existing .SNG file, make sure to move or re-name its corresponding audio directory as well. The main audio directory must be in the same folder as the .SNG file, and must be named as described above.

## Temporary audio files

If you're recording a new song, and haven't yet saved it as an .SNG file, the audio files are stored in a temporary location on disk. The directory structure is the same as described above, except that the main audio directory is named TEMP.

Once you save the song(s) to an .SNG file, these directories and audio files will be copied to the new "\_A" folder automatically. On the other hand, if for some reason you don't or can't save before turning off the power, you'll be given the chance to restore these audio files the next time that you start up the instrument, as described below.

## Recovering temporary audio files

If there are temporary audio files from the previous session, you'll see the following dialog the next time you start up the KRONOS:

/TEMP folder detected.

This folder may contain unsaved WAVE files from a previous audio track recording session.

Do you want to restore the /TEMP folder, or delete it from the disk?

[Restore] [Delete]

If you don't intend to use the WAVE files, we recommend that you delete them so they don't waste space on the internal disk. To delete them, press the Delete button.

If you want to save these files, press the Restore button to keep them.

Note that while the audio files can be recovered this way, the rest of the sequencer data cannot be restored.

## Audio input settings and recording source selection



If **Use Global Setting** is enabled, the Song will use these Global settings, and all of the other settings under Audio Input will be grayed out.

## Audio Input settings

Just as in Program and Combination modes, Sequencer mode includes a mixer for the audio inputs, including analog, USB, and S/P DIF. You can use this to mix and process the inputs prior to recording, if you like. For instance, you can mix several inputs together and send them to the same REC bus, or process an input through effects and then record the result.

As an alternative, you can ignore the mixer settings and just record directly from the inputs.

**Input 1 & 2** are the analog audio inputs from the INPUT 1 & 2 jacks. For more information, see "Analog AUDIO INPUTS" on page 8.

**USB 1 & 2** are the left and right channels of the USB audio input. For more information, see "USB ports" on page 8.

**S/P DIF L & S/P DIF R** are the left and right channels of the optical S/P DIF input. For more information, see "S/P DIF IN & OUT" on page 9.

## Use Global Setting

You can configure the audio inputs separately for each Song, if desired. Alternatively, you can use the Global setting, as made on the Global P0: Basic Setup— Audio page.

## Bus Select (IFX/Indiv.)

This specifies the output bus for each audio signal.

**Off:** The external audio input signal will not be sent to any bus. However, you can still record the external audio signal directly by using the P0: Play/REC– Audio Track Mixer page **REC Source** setting to choose an external input (Audio Input 1/2, S/P DIF L/R, USB 1/2) for recording.

**L/R:** The external audio input signal will be sent to the L/R bus. Choose this when you want other signals such as the KRONOS’ internal tone generator to be recorded along with an external audio source. Set **REC Source** to L/R.

**IFX1...12:** The external audio input signal will be sent to the IFX1–12 bus. Choose this when you want to apply an insert effect while recording. Set **REC Source** to match the post-IFX **Bus Select** setting.

**1...4:** The external audio input signal will be sent in mono to the selected individual output.

**1/2 and 3/4:** The external audio input signal will be sent via **Pan** in stereo to INDIVIDUAL 1/2 or 3/4. Set **REC Source** to the corresponding INDIV. setting.

 Be aware that if you change **Bus Select (IFX/Indiv.)** from Off to L/R or IFX, the volume level from AUDIO OUT L/MONO and R jacks or from the headphone jack may increase abruptly. Please use caution.

### FX Ctrl Bus (FX Control Bus)

This sends the external audio input signal to the FX Control bus (stereo two-channel (FX Ctrl1, 2)). For more information, see “FX Control Buses” on page 862 of the Parameter Guide.

### REC Bus

This sends the external audio input signal to the REC buses (four mono channels: 1, 2, 3, 4).

The REC buses are dedicated internal recording buses that you can use for recording or sampling audio tracks.

Recording becomes possible if you choose a REC bus as the “Source Bus.” For example, you can use the REC buses if you want to record only an audio input source that is being played along with the song being output from the L/R bus (i.e., record the input source, but not the song playback). You can also mix several audio inputs to the REC buses, or mix the direct signal from audio inputs to REC buses along with post-IFX sound and record the result.

**Off:** The signal will not be output to the REC buses. Normally you will leave this Off.

**1, 2, 3, 4:** The external audio input signal will be sent to the specified REC bus. The **Pan** setting is ignored, and the signal is sent in monaural.

**1/2, 3/4:** The external audio signal will be output to the REC buses in stereo. According to the **Pan** setting, it will be sent in stereo to buses 1 and 2, or 3 and 4.

### Send1 (to MFX1), Send2 (to MFX2)

These specify the level at which the external audio input signal will be sent to the master effects.

**Send1 (to MFX1)** sends the signal to master effect 1.

**Send2 (to MFX2)** sends the signal to master effect 2.

If **Bus Select (IFX/Indiv.)** is set to IFX1–12, the send levels to the master effects are specified by the **Send1** and **Send2** settings that follow IFX1–12.

### PLAY/MUTE

These indicate whether each external audio input signal is in Play or Mute condition.

Use the MIX PLAY/MUTE 1–6 switches to change the status.

### SOLO On/Off

This indicates the SOLO status of each external audio input signal. Use the MIX SELECT 1–6 switches to change the solo status.

Sound will be output only from channels whose SOLO is On. Other channels will be muted. Solo operation includes both MIDI tracks and audio tracks.

### Pan

This specifies the panning of each external audio input signal. If you are inputting a stereo audio source, you will normally pan the inputs to L000 and R127 respectively.

### Level

This controls the level of the external audio signal. The default is 127.

*Note:* the analog audio signals from AUDIO INPUTS 1 & 2 are converted into digital form by an A/D converter. The meter to the left of the **Level** fader shows the signal level immediately after conversion, and *before* the **Level** control. **Level** sets the volume of the signal immediately *after* the meter.

If the sound is distorted even though the **Level** setting is very low, see “Tips for eliminating distortion when using the analog inputs” on page 100.

### Avoiding extraneous noise

 If cables are connected to any of the audio inputs (analog, S/P DIF, or USB), any noise carried by the cables will enter into the KRONOS mixer structure. This may include hiss, hum, and other audio noise.

To avoid noise from unused audio inputs, either:

- Set the input’s **Level** to 0
- or
- Set all of the bus assignments to Off, including **Bus Select (IFX/Indiv. Out Assign)**, **REC Bus**, and **FX Control Bus**

If no audio cables are connected to the analog audio inputs, the input signals are forced to zero, preventing any additional noise.

---

## Audio Track Mixer

You can specify the audio source to record from, and change the Play/Mute status, SOLO status, pan, and volume for playback.

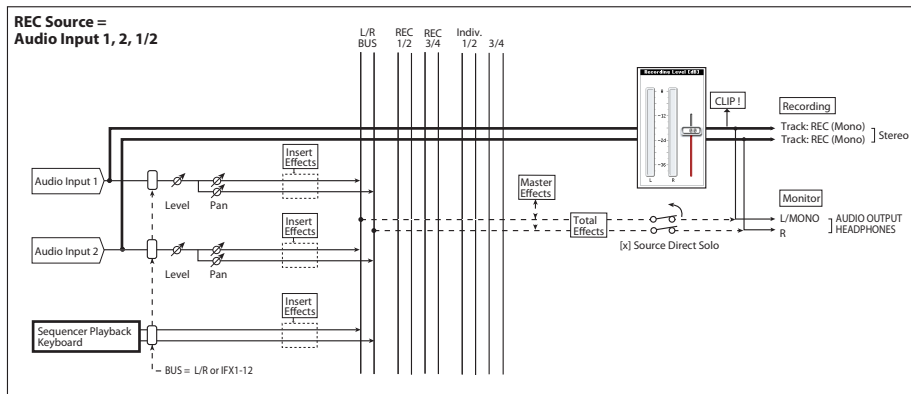

## REC Source

This selects the source that will be recorded on the track. The signal of the bus line you specify here will be recorded. See below for a diagram of buses when recording from the audio inputs; for more detailed diagrams, see under “0–2: Audio Track Mixer” on page 523 of the Parameter Guide.

If you set the **Track Select** field to Audio Track, you will be able to monitor the **REC Source** of that track.

The options will differ slightly depending on whether or not **Stereo Pair** is enabled.

**Audio Input 1, 2, 1/2, USB 1, 2, 1/2, or S/P DIF L, R, L/R:** Choose these to directly record the audio input from the analog, S/P DIF, or USB inputs. The inputs will be recorded directly without passing through the L/R bus, REC buses, or Individual buses. None of the Audio Input settings will affect the recorded signal; this includes **Bus (IFX/Indiv)**, **Pan**, **Level**, **Solo**, and **Play/Mute**. See the diagram “REC Source = Audio Input 1, 2, 1/2.”

If **Stereo Pair** is on and Audio Input 1/2 is selected, AUDIO INPUT 1 will be input to the odd-numbered track, and AUDIO INPUT 2 will be input to the even-numbered track. Similarly, USB 1/2. and S/P DIF L/R will be input to the odd-numbered and even-numbered tracks respectively.

**L, R, L/R:** The L/R bus after passing through TFX 1 and 2 will be recorded. Choose this if you want to record an external audio signal being sent to the L/R bus, or the sound being produced by the KRONOS (and sent to the L/R bus) in response to sequencer playback, keyboard playing, or MIDI input.

If **Stereo Pair** is on, L is sent to odd-numbered tracks, and R is sent to even-numbered tracks.

**REC 1, 2, 1/2, REC 3, 4, 3/4:** The REC 1/2 or REC 3/4 buses will be recorded. Choose this if you want to record only the audio input while hearing the sequencer playback and your keyboard playing from the L/R outputs. You can also mix several audio inputs to the REC buses, or use the REC buses to mix the direct sound from the audio inputs with the sound processed by insert effects, and record the result.

If **Stereo Pair** is on, REC bus 1 (3) is sent to odd-numbered tracks, and REC bus 2 (4) is sent to even-numbered tracks.

**Indiv.1..4, Indiv.1/2 and 3/4:** This allows you to record the signal at the individual outputs directly, without the need for an external cable. Similarly to using the REC buses, you can choose this when you want to monitor the L/R output while recording a different signal.

If **Stereo Pair** is on and you’ve selected Indiv.1/2, the Indiv. bus 1 will be sent to odd-numbered tracks, and Indiv. bus 2 will be sent to even-numbered tracks.

## Play/Rec/Mute

Use this to mute an audio track, or to select the recording tracks for multi-track recording. During playback, or for single-track recording (normal recording), it is possible only to select Play or Mute for tracks (playback tracks) other than the recording track. For multi-track recording, tracks can be set to Play, Mute, or Rec. The setting will alternate each time you press the Play/Rec/Mute button.

## Solo On/Off

This turns the Solo function on/off.

## Pan

This specifies the pan of audio track.

## Volume

Sets the volume of audio tracks 1–16.

## Recording procedure

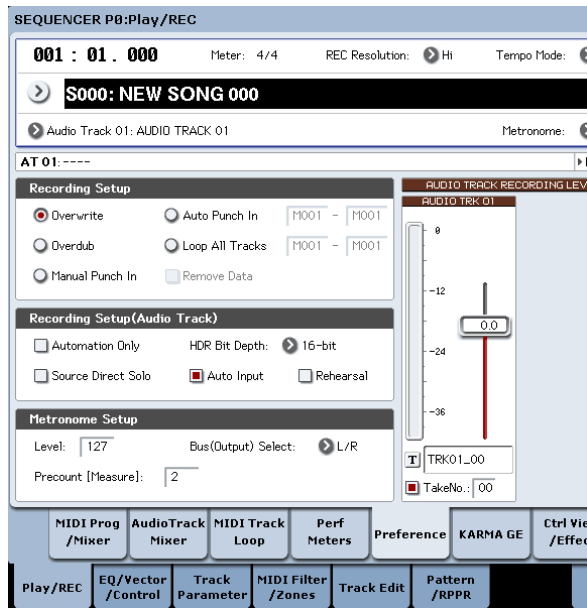

### Recording Setup

These parameters specify how audio tracks will be recorded.

For details on each recording method, refer to the examples for MIDI tracks. (See “Recording setup” on page 84)

However, this differs from MIDI track recording as follows.

#### Overwrite

When recording for the first time, you will normally select this method.

To begin recording, press the SEQUENCER REC/ WRITE switch and then the SEQUENCER START/ STOP switch. To stop recording, press the SEQUENCER START/STOP switch once again.

**Audio Track Audio Events:** Only the measures you recorded will be overwritten; the data in subsequent measures will remain unchanged.

**Audio Track Automation Events:** All data following the measure at which you begin recording will be erased.

#### Overdub

Select this method when you wish to add Audio Track Automation Event data to a previously-recorded track.

To begin recording, press the SEQUENCER REC/WRITE switch and then the SEQUENCER START/STOP switch. To stop recording, press the SEQUENCER START/STOP switch once again.

**Audio Track Audio Events:** As with Overwrite, only the measures you recorded will be overwritten; the data in subsequent measures will remain unchanged.

**Audio Track Automation Events:** The previously-recorded data will remain, and the newly-recorded data will be added to it.

#### Manual Punch In

Select this method when you wish to use the SEQUENCER REC/WRITE switch or a foot switch to re-record selected portions of a previously-recorded track.

#### Auto Punch In

Select this method when you wish to automatically re-record selected portions of a previously-recorded track.

For both Manual Punch In and Auto Punch In, recording will occur as follows.

**Audio Track Audio Events, Audio Track Automation Events:** Only the measures you recorded will be overwritten; the data in subsequent measures will remain unchanged.

#### Loop All Tracks

Choose this method if you want to repeatedly record track automation events over a specified region of measures, adding data at each pass. Only automation events can be recorded. You can use “Remove Data” to remove audio track automation events.

Audio events cannot be recorded. This means that if you set “Track Select” to Audio Track, and turn “Automation Only” Off, you will be unable to start recording.

### Recording Setup (Audio Track)

#### HDR Bit Depth

You can choose to record either 16-bit or 24-bit data. 24-bit yields higher fidelity, but uses more space on disk.

#### Automation Only

Normally you will record with this unchecked. Both audio track automation events and audio events will be recorded.

If this is checked, only audio track automation events will be recorded. Use this setting if you want to record automation after recording.

#### Auto Input

This parameter controls monitoring during recording. It automatically switches all record-enabled tracks between monitoring the record input and the track playback, according to whether or not recording is active.

This lets you listen to audio you’ve already recorded when punching in, and also means that you don’t have to disable track record-enables in order to listen to playback.

This applies only to record-enabled tracks. If Multi REC is off, this is the REC Track (as selected in the **Track Select** menu). If **Multi REC** is on, this means to all tracks whose **Play/Rec/Mute** button is set to Rec.

Normally, Auto Input should be enabled (checked). When enabled, record enabled tracks will be monitored as follows:

- When stopped, the monitor carries the input signal.
- When playing but not recording, the monitor carries the track playback.
- When recording, the monitor carries the input signal.

For audio tracks which are not record-enabled, you’ll always be monitoring the track playback.



**Audio track monitoring**

(Input: REC Source, Track: track playback)

	Auto Input	During Stop	During Play	During Rec	During Punch Rec		
					...In	In...Out	Out...
Record Tracks	On	Input	Track	Input	Track	Input	Track*
	Off	Input					
Other Tracks	On	Track Playback					
	Off						

**Source Direct Solo**

If this is unchecked, the L/R (post-TFX) and bus line signal(s) specified by **REC Source** will be sent from the L/R jacks and the headphone jack as specified by the Audio Input **Bus Select (IFX/Indiv.)** and post-IFX **Bus Sel.** settings. This is the normal state.

Normally you will leave this unchecked, and Check this if you want to monitor only the sound that’s being recorded. Only the signal of the bus line specified by **REC Source** will be output to the L/R jacks and the headphone jack. When using Multi REC, you’ll hear the sound from the **REC Source** buses whose **Play/Rec/Mute** setting is set to REC.

*Note:* If the **REC Source** is L/R, this setting is ignored; the L/R (post-TFX) signal is output from the L/R jacks and the headphone jack.

**Rehearsal**

Check this if you want to rehearse before actually recording on an audio track. (recording will not actually occur).

**Audio Track Recording Level**

This indicates the input level to the audio track selected for **Track Select** (when using single-track recording), or the input level to the audio tracks whose **Play/Rec/Mute** setting is REC (when using multi-track recording: maximum 4 tracks).

**Recording Level 1, 2, 3, 4  
Level Meter 1, 2, 3, 4**

This adjusts the final-stage signal level of each **REC Source** being recorded to the audio tracks.

The upper part of the level meter/slider shows the corresponding audio track number.

If you’re using single track recording, **Recording Level 1** and **Level Meter 1** both apply.

If you’re using multi-track recording, the settings for tracks whose **Play/Rec/Mute** is REC will be valid.

When using single-track recording, the level meter will show the recording level if you set “Track Select” to Audio Track. When using multi-track recording, press the SEQUENCER REC/WRITE switch to enter record-standby mode, and the level meter will show the recording level.

*Note:* The settings up to this point are the same as if you executed the page menu command **Auto HDR/Sampling Setup** with the HDR (Audio Track Recording) setting, to make the setup automatically. **Audio Input, REC Source,**

**Track Select,** and **Overwrite** are set automatically. For more information, see “Auto HDR/Sampling Setup” on page 632 of the Parameter Guide.

**Setting levels**

For the best results, set the levels as described below:

1. If **Multi REC** is off, set **Track Select** to an **Audio Track.**  
or  
If **Multi REC** is On, record-enable the desired **Tracks,** and then press the **SEQUENCER REC/WRITE** switch.

The **Level Meter(s)** will now show the recording level(s).

2. Initially, set the **Recording Level(s)** to **0.0dB.**
3. Adjust the level(s) of the input signal(s) so that it is as high as possible without activating the **CLIP!** or **ADC OVERLOAD!** messages.

If you’re using **AUDIO INPUTS 1** and/or **2,** adjust the volume using rear-panel **MIC/LINE** switches and **LEVEL** knobs.

If you’re using the **USB** or **S/P DIF** inputs, adjust the output level of your external audio source.

If you’re sampling external audio through the internal effects, you may also need to adjust the individual effects input and/or output level parameters.

If you’re using internal sounds, adjust the levels using the control surface, effects input/output trim, etc.

4. If the level is still not high enough, increase the **Recording Level** using the on-screen slider.

Again, the goal is to get the level as high as possible without activating the **CLIP!** or **ADC OVERLOAD!** messages.

**Tips for eliminating distortion when using the analog inputs**

If sound from the analog inputs is distorted, but the **CLIP!** message doesn’t appear, it’s possible that distortion is occurring at the analog input stage, or that distortion is being caused by the settings of the internal effects.

If the “**ADC OVERLOAD!**” message appears above the **Recording Level** meters, the distortion is due to excessive levels at the input. In this case, either lower the output level of the external audio source, or adjust the **MIC/LINE** gain select switch and **LEVEL** knob so that this message does not appear.

If there is distortion, but the “**ADC OVERLOAD!**” message does not appear, it’s possible that the distortion is being caused by the settings of the internal effects. To solve this problem, either lower the input **Level,** or adjust the effects settings (such as changing the individual effect Input Trim parameters).

**Examples of audio track recording**

**Recording an external input on audio track 1**

In this example, we’ll explain how a guitar connected to the Audio Input 1 jack can be recorded on audio track 1.

- Recording and playback on an audio track can occur until the end of the master track. You cannot record for longer than 80 minutes.

**Connect your guitar**

1. Connect your guitar to the rear panel AUDIO INPUT 1 jack.

Press the AUDIO INPUT MIC/LINE switch inward to select the LINE position, and set the LEVEL knob at about the center.

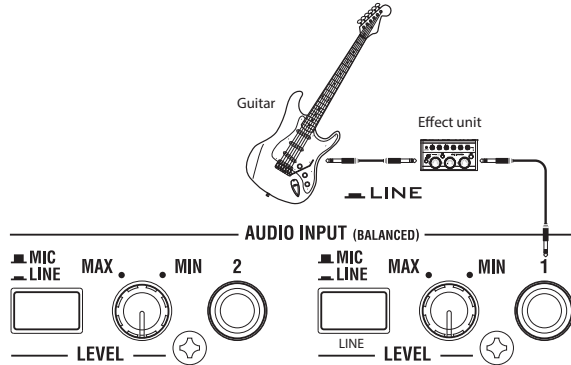

**⚠** If you connect a guitar with passive pickups (i.e., a guitar that does not contain a preamp), you will be unable to sample it at the correct level because of the impedance mismatch. Such guitars should be routed through a preamp or an effect unit first, and then connected to the KRONOS.

**Setup**

2. In the P0: Play/REC– Audio Input Sampling page, set the Audio Input parameters as described below.

Use Global setting Off

– INPUT 1 –

**Bus Select (IFX/Indiv.):** Off

**Pan:** L000

**Level:** 127

**REC Bus:** Off

*Note:* the meter to the left of the Level fader shows the signal level immediately after A/D conversion, before the Level control. Changing the Level will not affect the meter.

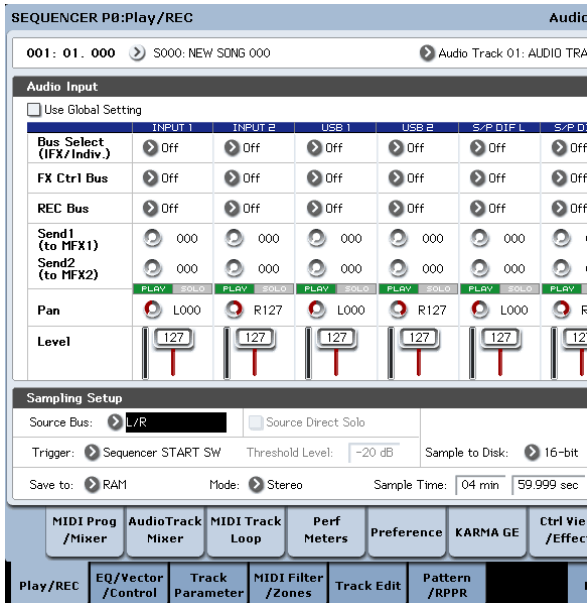

In the P0: Play/REC– Audio Track Mixer page, use **REC Source** to select Audio Input 1 (In 1), so that the signal

from Audio Input 1 will be recorded directly on audio track 1.

Audio Track 1 REC Source: Audio Input 1 (In 1)

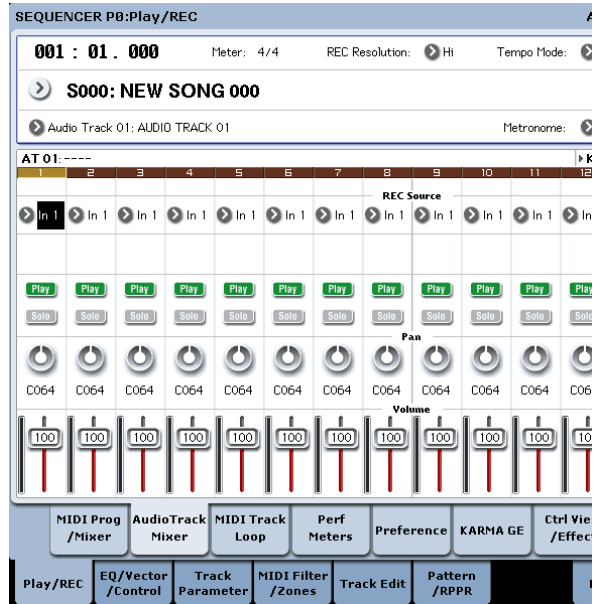

Go to the P8: Insert Effect– Audio Routing1 page.

Set the output for Audio Track 1 as follows.

**Bus Select (IFX/Indiv. Out Assign):** L/R

**Send1 (MFX1) and Send2 (MFX2):** 000

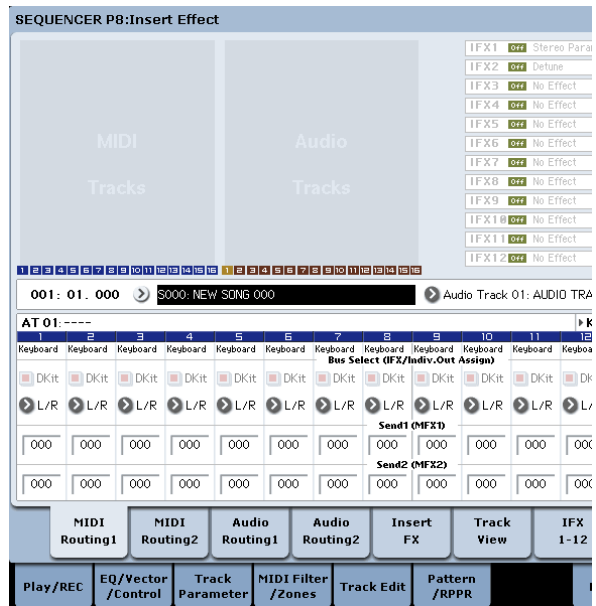

3. In the P0: Play/REC– Preference page, set “Track Select” to Audio Track 01.

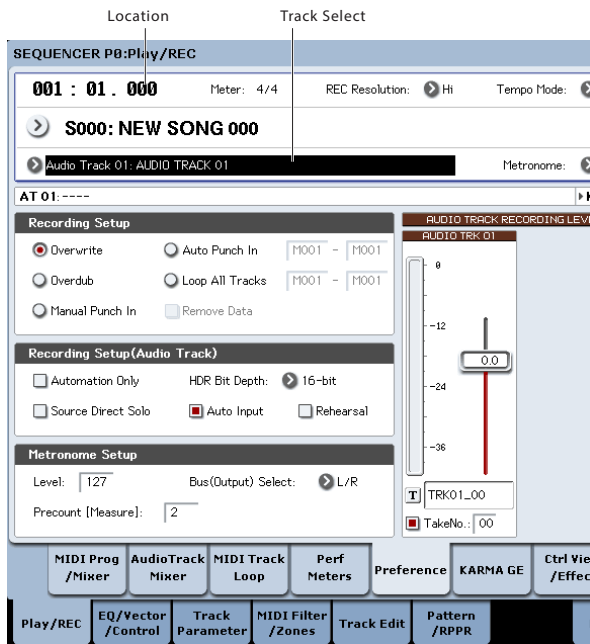

AUDIO TRK 01 (Level Meter 1, Recording Level 1, Name 1, Take, Take No.) will appear.

Use the **Name 1** field to specify a name for the region and WAVE file that will be created.

If you intend to record several takes on the same track, check the **Take** option box.

**4. Specify the recording method in Recording Setup and Recording Setup (Audio Track).**

**Overwrite:** selected

**Automation Only:** unchecked

**Source Direct Solo:** unchecked

**Auto Input:** checked

**Rehearsal:** unchecked

*Note:* If you want to record from the beginning of the song or from the measure specified by **Location**, you should select **Overwrite**.

*Note:* If **Take** is unchecked, you will be able to enter up to 24 characters as the file name. If it is checked, you will be able to input up to 22 characters.

*Note:* If you want the metronome to sound during recording, use **Metronome Setup** to make metronome settings. For more information, see “0–5d: Metronome Setup” on page 532 of the Parameter Guide.

**Set the recording level**

**5. Play your guitar at the volume you intend to record.**

If the “ADC OVERLOAD !” (AD converter input overload) indication appears, turn the rear panel LEVEL knob toward MIN to adjust the level appropriately.

For the best sound, adjust the level as high as possible without allowing the “ADC OVERLOAD !” indication to appear.

**6. The level meter will show the volume of the guitar signal that will be recorded.**

If the “CLIP !” indication appears, use the VALUE controller etc. to lower the **Recording Level** slider (located in the right side of the display) from +0.0 down to an appropriate level.

Press the SEQUENCER START/STOP switch to play back the song, and check the volume balance. If you want to monitor only the guitar sound during playback, check “Source Direct Solo.”

**Record**

**7. In the P0: Play/REC– Preference page, use “Location” to specify the location at which recording will begin.**

If you want to start recording from the beginning of the song, set this to 001:01.000.

**8. Press the SEQUENCER REC/WRITE switch**

The KRONOS will be in record-ready mode. If you’ve made metronome settings, the metronome will sound the count.

**9. Press the SEQUENCER START/STOP switch.**

Recording will start from the location you specified in “Location.”

If you have specified a metronome pre-count (“Precount [Measure]”), recording will begin after the pre-count. If a performance has already been recorded on a MIDI track, that MIDI track will also play back.

**10. To stop recording, press the SEQUENCER START/STOP switch.**

**Listen to the recorded result**

**11. Go to the P0: Play/REC– Audio Track Mixer page.**

In “Audio Track 1,” set the pan and volume etc. for audio track 1.

**Play/Rec/Mute:** Play

**Solo On/Off:** Off

**Pan:** C064

**Volume:** 100

**12. Press the SEQUENCER START/STOP switch to play back the song.**

*Note:* You can use functions such as Compare when recording audio events, just as you can when recording MIDI tracks.

*Note:* If you want to apply an insert effect on an audio track, set **Bus Select (IFX/Indiv. Out Assign)** to IFX1–IFX12.

Then select L/R as the **Bus Select** setting (P8: Insert Effect– Insert FX page) that follows the insert effect you used.

*Note:* If you want to apply master effects to an audio track, use **Send1 (MFX1)** and **Send2 (MFX2)** to set the send levels to the master effect. If you’re using an insert effect, adjust the **Send1** and **Send2** settings that follow that insert effect.

**Recording an external input source on audio track 2 while you listen to the previously-recorded audio track 1**

In this example, we’ll record another guitar performance on audio track 2 while monitoring the performance you previously recorded on audio track 1 as described in “Recording an external input on audio track 1.”

**1. In the P0: Play/REC– Audio Track Mixer page, set the Audio Input 2 REC Source to Audio Input 1 (In 1).**

AUDIO TRACK 2 REC Source: Audio Input 1 (In 1)



2. Set Track Select to Audio Track 02.
3. Record as described in step 8 and following of the preceding section.

### Applying an insert effect while you record

In this example, we'll apply an insert effect to the guitar that's connected to Audio Input 1, and record the effect-processed sound on audio track 1.

#### Connect your guitar

##### 1. Connect your guitar.

For detailed instructions, see "Recording an external input on audio track 1" on page 100.

#### Setup

2. In the P0: Play/REC– Audio Input/Sampling page, set the "Audio Input" parameters as shown below that the signal from the AUDIO INPUT 1 jack is sent to IFX1.

Use Global Setting: Off

Bus Select (IFX/Indiv.): IFX1

INPUT1 Level: 127

INPUT1 Pan: L000

INPUT1 REC Bus: Off

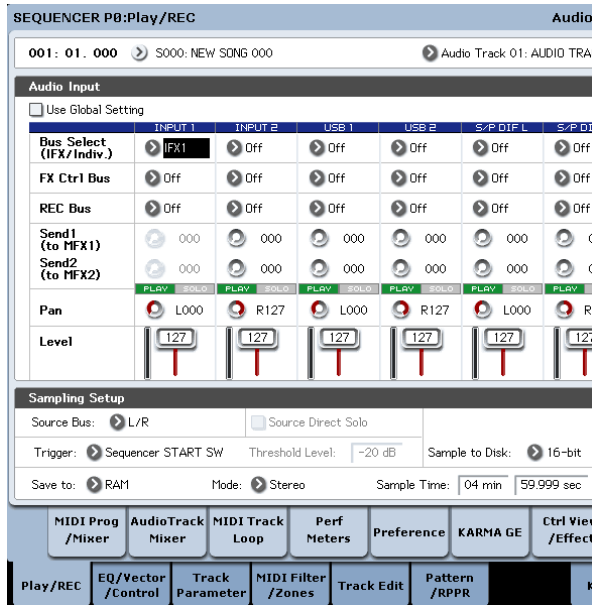

3. In the P8: Insert Effect– Insert FX page, select the desired effect and route it to REC bus 1.

IFX1 On/Off: On

IFX1: the desired effect

Bus Sel.: Off

REC Bus: 1

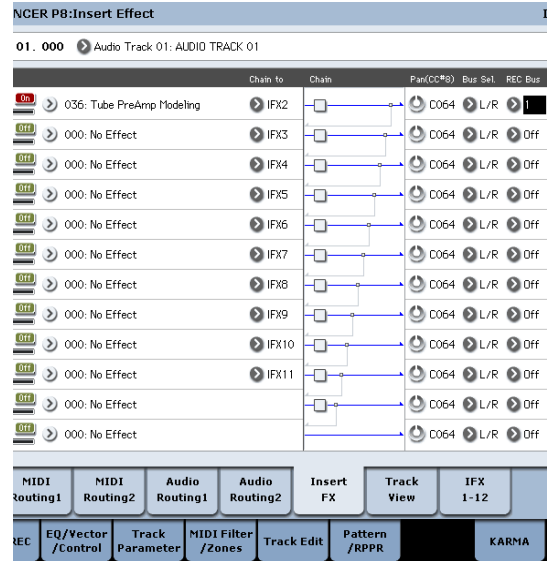

4. In the P0: Play/REC– Audio Track Mixer page, set REC Source to REC1 so that the signal of the REC bus will be recorded on audio track 1.

Audio Track 1 REC Source: REC1

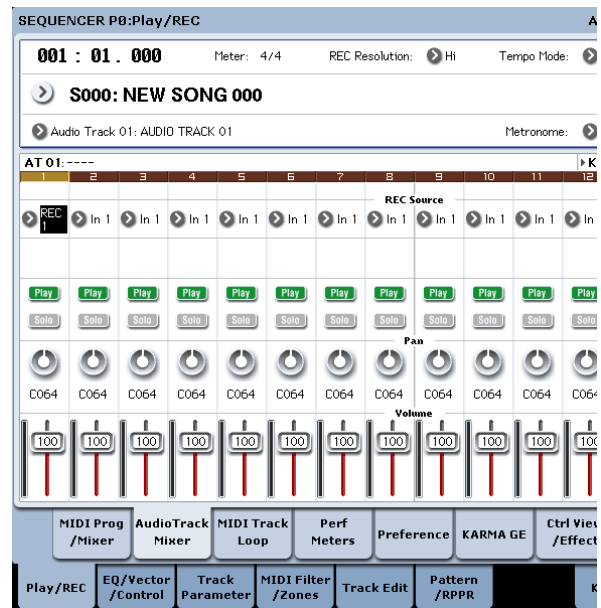

5. In the P0: Play/REC Preference page, set "Track Select" to Audio Track 01.

The remaining steps are the same as step 3 and following of the preceding section "Recording an external audio source on audio track 1." Please refer to that section for details.

### Punch-in recording an external input source on an audio track

In this example, we'll show how to punch-in record a portion of the track you recorded in "Recording an external input on audio track 1."

Don't change the P0: Play/REC– Audio Input/ Sampling page "Audio Input" settings, the P0: Play/ REC– Preference page "Recording Setup (Audio Track)" settings, or the "P0: Play/REC– Audio Track Mixer page REC Source settings. We will use these settings as they are.

### Setup

1. In the **P0: Play/REC– Preference page**, make sure that **Audio Track 01** is selected for the “Track Select” parameter.

2. Use **Recording Setup** to specify how recording will start.

In this example, choose punch-in recording.

**Auto Punch In:** on

**M\*\*\*–M\*\*\*:** Specify the range of measures for which you want to record.

**AUDIO TRK 01 Name, Take, Take No.:** Specify the region and wave file name that you want to record.

*Note:* If you set **Recording Setup** to Auto Punch In and set “M\*\*\*–M\*\*\*” to the desired range of measures, playback will occur until that range of measures, and then only the specified range of measures will be recorded.

If you set **Recording Setup** to Manual Punch In, the measures you specify by pressing the SEQUENCER REC/WRITE switch or foot switch will be recorded. In this case, press the SEQUENCER START/STOP switch to play back the song. When you reach the measure at which you want to start recording, press the SEQUENCER REC/WRITE switch or the foot switch to begin recording. When you reach the measure at which you want to stop recording, press the REC/WRITE switch or foot switch once again; recording will end.

### Rehearse

If desired, you can simulate the action of recording without actually recording. This will function just as if you were recording, but no audio event, region, or WAVE file will be created.

3. In “**Recording Setup (Audio Track)**,” check the “**Rehearsal**” option.
4. Use “**Location**” to specify the location at which you want to start recording. Set this several measures earlier than the region you specified for “M\*\*\*–M\*\*\*”.
5. Press the **SEQUENCER REC/WRITE** switch.  
You will enter record-ready mode.  
Once you press the SEQUENCER REC/WRITE switch, you will be unable to change the audio track selection in “Track Select.”
6. Press the **SEQUENCER START/STOP** switch.  
Playback will begin from the measure specified by “Location,” and simulated recording will occur only in the range of measures specified by “M\*\*\*–M\*\*\*”. Then playback will resume, and will continue to the end of the song.  
*Note:* If the “Recording Setup (Audio Track)” parameter “Auto Input” is Off, you will always be able to hear the REC Source. For more information, see “Auto Input” on page 531 of the Parameter Guide.
7. Press the **SEQUENCER START/STOP** switch to stop recording.
8. In “**Recording Setup (Audio Track)**,” uncheck the “**Rehearsal**” option.

### Record

9. Use “**Location**” to specify the location at which you want to start recording. Set this several measures

earlier than the region you specified for “M\*\*\*–M\*\*\*”.

10. Press the **SEQUENCER REC/WRITE** switch.

You will enter record-ready mode.

Once you press the SEQUENCER REC/WRITE switch, you will be unable to change the audio track selection in “Track Select.”

11. Press the **SEQUENCER START/STOP** switch.

Playback will begin from the measure specified by “Location,” and recording will occur only in the range of measures specified by “M\*\*\*–M\*\*\*”. Then playback will resume, and will continue to the end of the song.

*Note:* If the “Recording Setup (Audio Track)” parameter “Auto Input” is Off, you will always be able to hear the REC Source.

12. Press the **SEQUENCER START/STOP** switch to stop recording.

### Listen to the recorded result

13. Press the **SEQUENCER START/STOP** switch to play back the song.

Make output settings for the audio track as described under “Listen to the recorded result” on page 102.

14. Press the **SEQUENCER START/STOP** switch to stop playback.

### Compare the recorded result

- Press the COMPARE switch (the COMPARE switch LED will light), and play back.

The audio track prior to punch-in recording will play back.

- Once again press the COMPARE switch (the COMPARE LED will go dark), and play back.

The audio track following punch-in recording will play back.

## Other variations of audio track recording

### Bouncing audio tracks

Bouncing lets you combine two or more tracks into either a single mono track, or a stereo pair.

In this example, we'll show how audio tracks 1 and 2 can be bounced to audio track 3.

Before you proceed, you'll need to record onto audio tracks 1 and 2. To record on audio track 2, make settings as described under "Recording Setup" on page 99, but in the P0: Play/REC– Audio Track Mixer page, set Audio Track 2 **REC Source** to REC1, and in the P0: Play/REC– Preference page, set "Track Select" to Audio Track 02.

#### Setup

1. In the P0: Play/REC– Audio Track Mixer page, set up both audio tracks 1 and 2 as shown below:

**Play/Rec/Mute:** Play

**Solo On/Off:** On

**Pan:** L000

**Volume:** 127

*Note:* By turning on **Solo** for both AUDIO 1 and AUDIO 2, you are specifying that only these audio tracks will be heard and recorded.

2. In the P8: Insert Effect– Audio Routing 1 page, set up both audio tracks 1 and 2 as shown below:

**Bus Select (IFX/Indiv. Out Assign):** L/R

**Send 1 (MFX1) and Send 2 (MFX2):** 000

*Note:* If you want to apply insert effects to the audio tracks, set **Bus Sel. (IFX/Indiv. Out Assign)** to your choice of IFX1–IFX12. Then choose L/R for the **Bus Select** setting (P8: Insert Effect– Insert FX page) that follows the insert effect you're using.

*Note:* If you want to apply master effects to an audio track, use "Send 1 (MFX1)" and "Send 2 (MFX2)" to adjust the send levels to the master effects. If you are using an insert effect on the audio track, adjust the **Send1** and **Send2** that follow the insert effect you're using.

3. Press the SEQUENCER START/STOP switch to play back the song, and adjust the balance of the audio track 1 and 2 output levels.

The output level of each audio track is adjusted in the P0: Play/REC Audio Track Mixer page by the audio track 1 and audio track 2 **Volume** setting.

When you've finished making adjustments, stop playback.

4. In the P0: Play/REC– Preference page, use "Track Select" to select Audio Track 03.
5. In Recording Setup, Recording Setup (Audio Track), specify the desired recording method.

– Recording Setup –

**Overwrite:** on

– Recording Setup (Audio Track) –

**Automation Only:** unchecked

**Source Direct Solo:** unchecked

**Auto Input:** checked

**Rehearsal:** unchecked

– Audio TRK 03 –

**Name, Take, Take No.:** Specify the desired region and WAVE filename to be recorded.

*Note:* The settings up to this point are the same as if you used the page menu command **Auto HDR/Sampling Setup** to execute Bounce Audio Track with the following settings. For more information, see "Bounce Audio Track" on page 634 of the Parameter Guide.

**Mode:** Mono

**From:** Audio Track 01: checked

**Audio Track 02:** checked

**To:** Audio Track 03

6. In the P0: Play/REC– Audio Track Mixer page, set **REC Source** so that L will be recorded on audio track 3.

Audio track 3 **REC Source:** L



When bounce-recording audio tracks, turn the metronome off (Metronome Setup "Sound": Off).

#### Record

7. Set "Location" to the beginning of the song (001: 01.000).

8. Press the SEQUENCER REC/WRITE switch.

You will be in record-ready mode.

9. Press the SEQUENCER START/STOP switch.

Playback will begin, and bounce-recording will also begin simultaneously.

When the audio tracks have finished playing back, recording will also end. Song playback will also end automatically.

#### Listen to the recorded result

10. In the P0: Play/REC– Audio TRACK Mixer page, mute the playback of both audio tracks 1 and 2.

**Play/Rec/Mute:** Mute

**Solo On/Off:** Off

11. Press the SEQUENCER START/STOP switch to play back the song.

Make output settings for audio track 3 as described in "Listen to the recorded result" on page 102.

12. Press the SEQUENCER START/STOP switch to stop playback.

If you want to create a WAVE file on the disk from a song that includes audio tracks, see "Resampling a song to create a Wave file" on page 160.

## Recording automation events for pan, EQ, and volume etc. on an audio track

All audio track parameters (**Pan**, **Volume**, **Send1/2**, and **EQ**) can be recorded in realtime. In this example, we'll record **Pan** and **Volume** changes on audio track 3.

Go to the P0: Play/REC– Audio Track Mixer page, and use “Track Select” to select Audio Track 03 as the track to be recorded. You could use the VALUE controller to operate a desired parameter, but using the control surface lets you mix up to eight tracks simultaneously.

### Setup

1. Go to the P0: Play/REC– Preference page.
2. In Recording Setup, Recording Setup (Audio Track), choose the desired recording method.

In this example, we'll choose overdub recording so that we can record repeated passes, adding more automation data on each pass.

– Recording Setup –

**Overdub:** on

– Recording Setup (Audio Track) –

**Automation Only:** checked

 If you record without checking “Automation Only,” audio events will also be recorded. Note that this will erase and overwrite the audio events that already exist.

3. Go to the P0: Play/REC– Control Surface page.

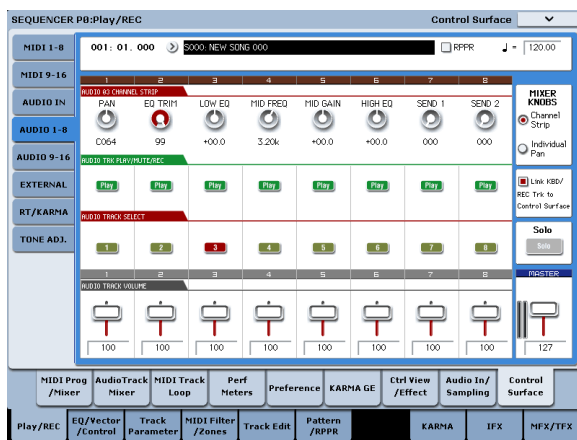

4. Press the CONTROL ASSIGN AUDIO switch several times so that the HDR1–8 LED located at the right of the switch is lit.
5. In the center of the right edge of the LCD, check “Link KBD REC Trk to Ctrl Surface.”

If you check this and press the MIX SELECT 3 switch, each knob will control audio track 3, and at the same time “Track Select” will switch to Audio Track 03.

Press the SEQUENCER START/STOP switch to play back, and operate the knobs and sliders etc. to rehearse your mix.

If MIXER KNOB is set to CHANNEL STRIP, knob 1 will control pan, knobs 2–6 will control EQ, and knobs 7 and 8 will control the send levels. Use slider 3 to adjust the volume of audio track 3.

When you've finished rehearsing, press the SEQUENCER START/STOP switch to stop. Press the LOCATE switch.

### Record

6. Press the SEQUENCER REC/WRITE switch.

The metronome will begin sounding, and you will be in record-ready mode.

7. Press the SEQUENCER START/STOP switch.

After a two-measure count, recording will begin. Use the sliders etc. to control the volume.

*Note:* When recording automation events, you can use quantization, the resolution setting, and the compare function in the same way as for a MIDI track.

8. When you're finished recording, press the SEQUENCER START/STOP switch to stop recording.

9. Listen to the recorded result.

Press the SEQUENCER START/STOP switch to play back.

If you want to record again, use the Compare function (press the COMPARE switch) to re-record.

10. If you want to continue adding automation events, repeat the recording procedure from step 6.

## Placing a WAVE file in an audio track

You can play back a WAVE file by importing it into a region of an audio track.

**Important:** You can only directly import WAVE files from the internal disk. To use files from CDs or external USB devices, you must first copy them to the internal disk, and then import the copied file into the Song.

*Note:* To be imported, WAVE files must be at 44.1kHz or 48 kHz sample rate, and less than 80 minutes long.

1. Go to the P4: Track Edit page.
2. Use “Track Select” to select the audio track in which you want to place the WAVE file.
3. Choose the “Audio Event Edit” page menu command to open the dialog box.

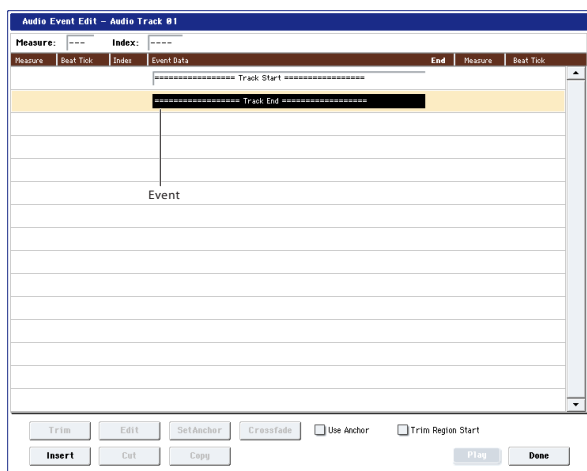

4. Select the event at which you want to insert a region, and press the Insert button located at the lower left. A dialog box will open.

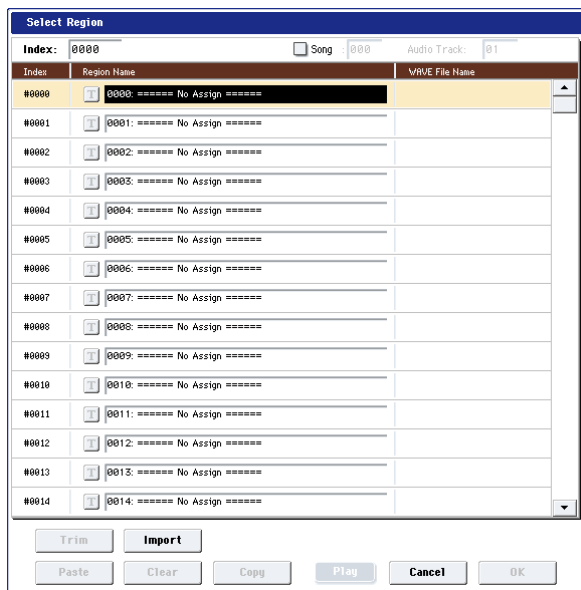

5. Select the region into which you want to import the WAVE file, and press the Import button located below. A dialog box will open.

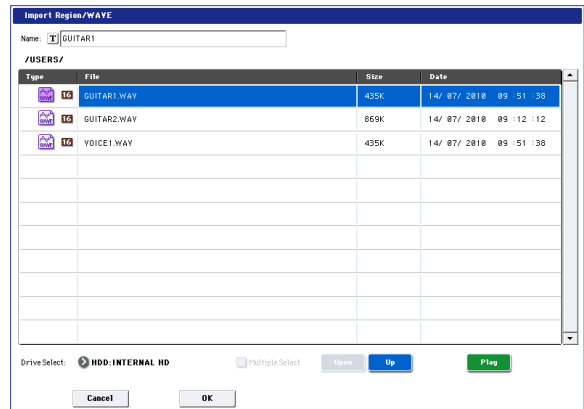

6. Use “Drive Select,” “Open,” and “Up” to navigate to the desired directory, select the WAVE file you want to import, and press the OK button to import the file into the region.

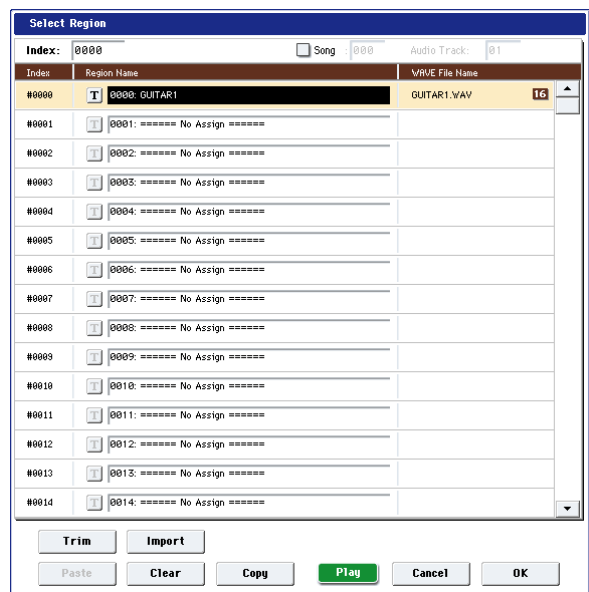

When selecting a WAVE file, you can press the Play button to audition the files to help you find the desired one.

You can also use the “Name” field located above to assign a name to the region. Edit the “Name” after you’ve selected a file.

*Note:* The OK and Play buttons are available only if you’ve selected a 44.1 kHz or 48 kHz WAVE file. Otherwise, the button will be grayed-out and you won’t be able to press it.

 Editing a region will affect the audio track for the entire song. Use caution when editing a region that’s already used in an audio track.

7. Press the OK button, the selected region will be placed in the audio track.

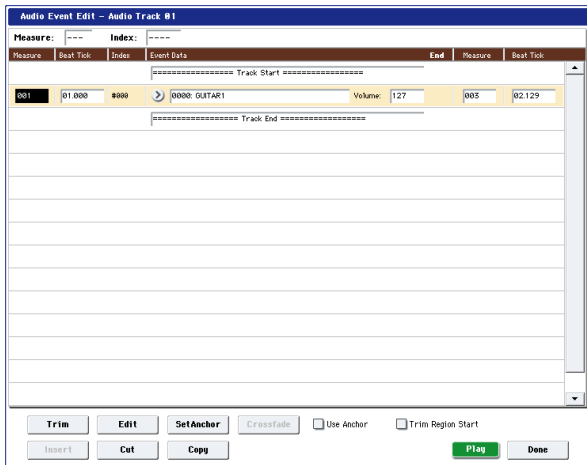

8. Select the event that you want to edit, and use the location parameters “Measure” and “Beat Tick” to edit the location of the event.

 You can't place two or more events at the same location.

9. Press the Done button.

10. Press the SEQUENCER START/STOP switch, and make sure that the WAVE file plays back.

You can press the COMPARE switch to return to the state prior to the edit you just performed.

We've kept this example simple, but you can also perform editing operations such as changing the playback position of the WAVE file in steps of a single sample, changing the location relative to an anchor point, or crossfading two audio events. For more information, see “Audio Automation Edit” on page 643 of the Parameter Guide.

## Song editing

You can apply a variety of editing operations to Songs, MIDI Tracks, and Audio Tracks, as described below.

---

## Songs

**Initialize Song:** This command erases all data in the current song, and restores all parameters to their default states. For more information, see “Initialize Song,” as described on page 627 of the Parameter Guide.

**Copy From Song:** This command copies all of the setting data and musical data from the specified song to the currently selected song. For more information, see “Copy From Song” on page 627 of the Parameter Guide.

**FF/REW Speed:** This allows you to set the speed at which fast-forward or rewind will occur when you press the FF or REW buttons. For more information, see “FF/REW Speed” on page 628 of the Parameter Guide.

**GM Initialize:** This command transmits a GM System On message to the Sequencer mode, resetting all MIDI tracks to the GM settings. For more information, see “GM Initialize” on page 629 of the Parameter Guide.

**Bounce All Tracks To Disk:** This command records all tracks in the song to a single stereo WAVE file. For more information, see “Bounce All Tracks To Disk” on page 638 of the Parameter Guide.

**Set Song Length:** This command changes the length of the specified song. When it is executed, the length of the master track will change, and the number of measures played will change. For more information, see “Set Song Length” on page 644 of the Parameter Guide.

---

## Auto HDR/Sampling Setup

This command walks you through making the appropriate settings for various common operations, including disk recording, audio track bouncing, sampling/resampling (in-track sampling, etc.), and creating an audio CD. For more information, see “Auto HDR/Sampling Setup” on page 632 of the Parameter Guide.

**Initialize:** Sets audio recording and sampling parameters to their default values.

**HDR (Audio Track Recording):** Makes the necessary settings for recording external audio, such as guitars or vocals.

**Bounce Audio Track:** Makes the necessary settings for bounce-recording audio tracks.

**2ch Mix to Disk:** Makes settings for resampling a completed song to a stereo WAVE file. You can then burn these files to a CD on a USB CD-R/RW drive (not included), using the Disk mode Make Audio CD page.

**Resample SEQ Play:** Makes settings for resampling.

**In-Track Sampling:** Makes settings for sampling external audio using In-Track Sampling.

---

## MIDI Tracks

---

### Track editing

**MIDI Step Recording:** It allows you to specify the length and velocity of each note numerically, and to input MIDI data, the pitches, from the keyboard. You can use the Rest button and Tie button to enter a rest or tie. For more information, see “MIDI Step Recording” on page 639 of the Parameter Guide.

**MIDI Event Edit:** Here you can edit individual events of MIDI data. For more information, see “MIDI Event Edit” on page 640 of the Parameter Guide.

**Bounce Track:** This command combines the musical data of the bounce source and bounce destination tracks, and places the combined data in the bounce destination. All musical data in the bounce source will be erased. For more information, see “Bounce Track” on page 645 of the Parameter Guide.

**Create Control Data:** This command creates control change, aftertouch, pitch bend, or tempo data in the specified region of a MIDI track or the master track. For more information, see “Create Control Data” on page 650 of the Parameter Guide.

**Erase Control Data:** This command erases data such as control changes, after touch, pitch bend, or tempo in the specified range. For more information, see “Erase Control Data” on page 651 of the Parameter Guide.

**Quantize:** This command corrects the timing of MIDI data of the type you specify (note data, control change, aftertouch, pitch bend, program change, etc.) in the track. For more information, see “Quantize” on page 651 of the Parameter Guide.

**Shift/Erase Note:** This command shifts (moves) or erases the specified note numbers in a specified MIDI track and range of measures. For more information, see “Shift/Erase Note” on page 652 of the Parameter Guide.

**Modify Velocity:** This command modifies the velocity values of notes in the specified area so that they will change over time according to a selected curve. For more information, see “Modify Velocity” on page 653 of the Parameter Guide.

---

### Pattern editing

**Step Recording (Loop Type):** Here you can perform step recording into a pattern. For more information, see “Step Recording (Loop Type)” on page 656 of the Parameter Guide.

**Event Edit:** Here you can edit individual events of the musical data in a pattern. For more information, see “Event Edit” on page 657 of the Parameter Guide.

**Pattern Parameter:** This command specifies the number of measures and the time signature of the selected pattern. For more information, see “Pattern Parameter” on page 657 of the Parameter Guide.

**Erase Pattern:** This command erases the data from the selected pattern. For more information, see “Erase Pattern” on page 657 of the Parameter Guide.

**Copy Pattern:** This command copies the settings and musical data of the selected pattern to another pattern. For more information, see “Copy Pattern” on page 657 of the Parameter Guide.

**Bounce Pattern:** This command combines the musical data of the bounce source pattern and bounce destination pattern, and places the combined musical data in the bounce destination. For more information, see “Bounce Pattern” on page 657 of the Parameter Guide.

**Get From MIDI Track:** This command takes musical data from a MIDI track and loads it into the specified pattern. For more information, see “Get From MIDI Track” on page 658 of the Parameter Guide.

**Put To MIDI Track:** This command places a pattern into a MIDI track. For more information, see “Put To MIDI Track” on page 658 of the Parameter Guide.

**Copy To MIDI Track:** This command copies the specified area of musical data from the specified pattern to a MIDI track as musical data. For more information, see “Copy To MIDI Track” on page 659 of the Parameter Guide.

**Convert to Drum Track Pattern:** This command converts a user pattern into a user drum track pattern, which can then be used with the Drum Track in any mode. For more information, see “Convert to Drum Track Pattern” on page 659 of the Parameter Guide.

**Load Drum Track Pattern:** This command loads a user Drum Track pattern into a user pattern. For more information, see “Load Drum Track Pattern” on page 659 of the Parameter Guide.

**Erase Drum Track Pattern:** This erases the specified Drum Track pattern. For more information, see “Erase Drum Track Pattern” on page 638 of the Parameter Guide.

---

## Common to MIDI tracks and audio tracks

**Erase Track:** This command erases the data from the specified track. It is not possible to erase the master track by itself. For more information, see “Erase Track” on page 645 of the Parameter Guide.

**Copy Track:** This command copies musical data from the copy source track to the specified track. For more information, see “Copy Track” on page 645 of the Parameter Guide.

**Erase Measure:** This command erases the specified type(s) of musical data from the specified range of measures. The Erase Measure command can also be used to remove only a specific type of data. Unlike the Delete Measure command, executing the Erase Measure command does not cause the subsequent measures of musical data to be moved forward. For more information, see “Erase Measure” on page 646 of the Parameter Guide.

**Delete Measure:** This command deletes the specified measures. When the Delete Measure command is executed, the musical data following the deleted measures will be moved towards the beginning of the sequence. For more information, see “Delete Measure” on page 646 of the Parameter Guide.

**Insert Measure:** This command inserts the specified number of measures into the specified track. When you execute the Insert Measure command, the musical data following the insert location will be moved backward. For more information, see “Insert Measure” on page 647 of the Parameter Guide.

**Repeat Measure:** This command repeatedly inserts the specified measures for the specified number of times. When you execute the Repeat Measure command, the measures will be inserted following the measure specified by “To End of Measure,” and musical data following the inserted data will be moved backward. For more information, see “Repeat Measure” on page 648 of the Parameter Guide.

**Copy Measure:** This command copies the measures of musical data specified as the “From” source to the beginning of the measure specified as the “To” location. When you execute the Copy Measure command, the existing track data at the copy destination will be rewritten. For more information, see “Copy Measure” on page 649 of the Parameter Guide.

**Move Measure:** This command moves the specified measures of performance data to another measure. When you execute the Move Measure command, the performance data following the move-source measures will move forward by the corresponding number of measures, and the performance data following the move-destination will move backward (i.e., later in the song) by the same number of measures. For more information, see “Move Measure” on page 649 of the Parameter Guide.



---

## Audio Tracks

**Audio Event Edit:** This command lets you edit individual audio events that have been recorded, or trim (i.e., make adjustments in steps of a single sample to) the region used by audio events. For more information, see “Audio Event Edit” on page 641 of the Parameter Guide.

**Audio Automation Edit:** This lets you edit individual automation data events. For more information, see “Audio Automation Edit” on page 643 of the Parameter Guide.

**Region Edit:** Here’s how to edit the regions used in an audio track. In addition to Importing or Pasting a region, you can use the Trim dialog box to specify the range in which a WAVE file will play back. For more information, see “Region Edit” on page 653 of the Parameter Guide.

**Volume Ramp:** This command modifies the data values (volume) of the specified area. You can gradually increase (Fade In) or decrease (Fade Out) the volume between the start and end points. For more information, see “Volume Ramp” on page 655 of the Parameter Guide.

**Copy Song’s Tempo to Region:** This command changes the tempo used by the specified regions of audio events so that the audio event tempo will match the tempo of the location in which those regions play back.

If the tempo of an audio track matches the tempo of the MIDI tracks, executing this command to match the region tempo will ensure that the “Adjust Region to Song’s Tempo (Time Stretch)” or “Adjust Song’s Tempo to Region” commands can be executed correctly. For more information, see “Copy Song’s Tempo to Region” on page 655 of the Parameter Guide.

**Adjust Song’s Tempo to Region:** This command creates tempo events in the master track to match the tempo of the regions used by the audio events in the specified range.

This is useful if you create audio tracks in a previously-recorded region, and want all tracks (including MIDI tracks) to match that region. For more information, see “Adjust Song’s Tempo to Region” on page 656 of the Parameter Guide.

**Adjust Region to Song’s Tempo (Time Stretch):** If the tempo of regions used by audio events in the specified range differs from the tempo of the range in which those regions play back, you can execute Time Stretch (Sustaining) to create new WAVE files and regions. Audio events that use the newly created regions will also be created automatically.

If you want to modify the tempo of an existing song, it is convenient to first specify the desired tempo in the master track, and then execute this command so that the audio track(s) will be created according to the new tempo. For more information, see “Adjust Region to Song’s Tempo” on page 656 of the Parameter Guide.

## Using RPPR (Realtime Pattern Play/Record)

	Assign	Bank	Pattern Name	Track Name	Mode	Shift	Sync	Info.
C#2	<input checked="" type="checkbox"/>	Preset	P001: Pop & Ballad 1 [Std]	T01: MIDI TRACK 01	Manual	+00	Measure	I-F078: Studio Standard Kit
D2	<input checked="" type="checkbox"/>	Preset	P002: Pop & Ballad 2 [Std]	T01: MIDI TRACK 01	Manual	+00	Measure	I-F078: Studio Standard Kit
D#2	<input checked="" type="checkbox"/>	Preset	P003: Pop & Ballad 3 [Std]	T01: MIDI TRACK 01	Manual	+00	Beat	I-F078: Studio Standard Kit

This section explains how to assign a pattern to RPPR, and how to play and record using RPPR.

### Creating RPPR data

1. Create a new song, and choose a drum program for MIDI track 1.
2. Select the RPPR Setup tab of the P5: Pattern/RPPR page. In this page, the RPPR function is automatically turned on.

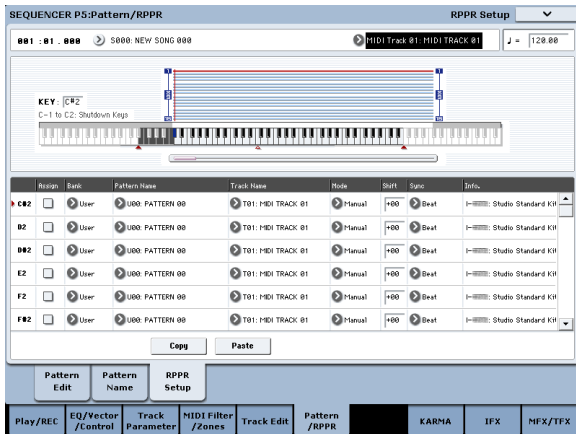

3. Select the key to which the pattern will be assigned. Select C#2. Hold down the ENTER switch and play a key, or use the scroll bar located at the right to find the key.
 

*Note:* C2 and lower keys are used to stop playback, and cannot be assigned.
4. Check "Assign" for C#2.
5. Set "Bank" to Preset, and set "Pattern Name" to P001.

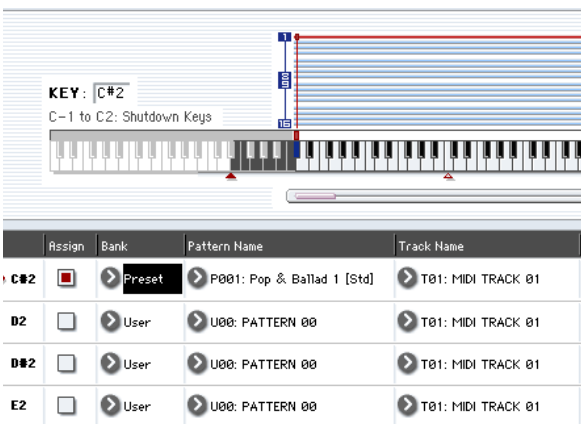

6. Set "Track Name" to T01.
 

The selected pattern will be played according to the settings (program, etc.) of the track you select here.

7. With the C#2 parameter selected, press the Copy button.
8. Assign patterns to other keys.

Select the D2 parameter, and press the Paste button.

The "Assign," "Bank," "Pattern Name," "Track Name," "Mode," "Shift," and "Sync" settings you made in steps 5 and 6 will be copied automatically.

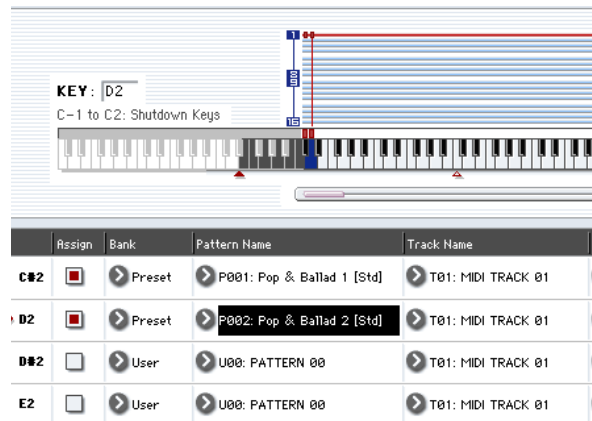

9. Modify only the "Pattern Name." Select "Pattern Name," and press the ^ switch to select P002.
10. Select the D#2 parameter, and press the Paste button.
 

The "Assign," "Bank," "Pattern Name," "Track Name," "Mode," "Shift," and "Sync" settings you made in steps 5 and 6 will be copied automatically.

Similar to step 9, set "Pattern" to P003.

*Note:* When making RPPR settings, you can use the Copy button and Paste button in this way to efficiently assign the "Bank," "Pattern Name," and "Track Name" etc. to each key.

Similar to step 9, set "Pattern" to P003.

*Note:* When making RPPR settings, you can use the Copy button and Paste button in this way to efficiently assign the "Bank," "Pattern Name," and "Track Name" etc. to each key.

11. As described above, assign several other patterns such as P004 and higher.

12. Press the C#2 key. The assigned pattern will play.

Take your finger off the C#2 key, and press the D2 key. The pattern will change, and playback will begin. At this time, the pattern operation will depend on the "Sync" and "Mode" setting.

Set "KEY" to C#2, and set "Sync" to Measure. Make the same setting for D2 (See the diagram above).

Now press the notes consecutively. Notice that the patterns operate in a different way.

With the "Measure" setting, patterns will be handled in one-measure units. The second and subsequent patterns

will start in sync with the end of previously played pattern.

If you change the “Mode” setting to **Once**, the entire pattern will playback to the end even if you release your finger from the keyboard immediately.

**13. To stop playback, either press the same key once again, or press the C2 or lower key.**

## RPPR playback

Let’s use the RPPR you created to perform in the P0: Play/REC– MIDI Track Prog Select/Mixer page.

- 1. Select the P0: Play/REC– MIDI Track Prog Select/Mixer page (See the diagram below).**
- 2. Check the “RPPR” check box.**

The RPPR function will be turned on. Set the on/off for each song.

- 3. Play the keyboard, and patterns will begin playing according to the RPPR settings.**
  - Pattern playback for a key with a “Sync” setting of Beat or Measure will sync to the playback of the first pattern. For more information, see “Sync” on page 595 of the Parameter Guide.
  - If you are playing the pattern in synchronization (when “Sync” is Beat, Measure, or SEQ), the pattern will start accurately if you play the note slightly earlier than the timing of the beat or measure. Even if you play the note slightly later than the beat or measure (but no later than a 32nd note), it will be considered to have started at the beat or measure, and the beginning of the pattern will be compressed so that the remainder of the playback will be correct.

If you wish to trigger the RPPR function from an external MIDI device, use the MIDI channel that is selected for “Track Select.”

- 4. To turn off the RPPR function, uncheck the RPPR check box.**

## Play RPPR while a Song plays back

RPPR can be played in synchronization with the playback of a song.

Pattern playback for a key with a “Sync” setting of SEQ will synchronize to the playback of the song. (See “Sync” on page 595 of the Parameter Guide.) Start the song playback, and then press the key. The pattern playback will start in synchronization with the measures of the song.

 Synchronization will be lost if you use the << REW or FF >> switches while a song is playing.

*Note:* If you want RPPR pattern playback to begin at the moment that song playback begins, it is a good idea to insert an empty measure containing no musical data before the song playback begins.

*Note:* If the song is stopped, the pattern will synchronize to the timing of KARMA.

## Recording an RPPR performance

You can record RPPR performances in real-time.

If you are using only one track (such as MIDI Track 01), set “Track Select” to the desired track, and un-check Multi Rec.

On the other hand, even if RPPR uses only one track, use multi-track recording if you will be selecting another track in “Track Select” and recording its performance at the same time.

You should also select multi-track recording if you specified the RPPR data using multiple tracks rather than just a single track, and want to simultaneously record the performance of multiple tracks.

*Note:* The RPPR pattern will be recorded as performance data on the tracks used by the pattern.

In this example, we’ll explain how you can record an RPPR performance and a keyboard performance at the same time. Before you continue, use the P0: Play/REC– MIDI Track Prog Select/Mixer page to assign a drum program to MIDI track 1, and a bass program to MIDI track 2.

- 1. Assign several keys starting with C#2 to preset patterns.**

Check the C#2 “Assign” setting, and set “Bank” to Preset and “Pattern Name” to the desired preset pattern. For

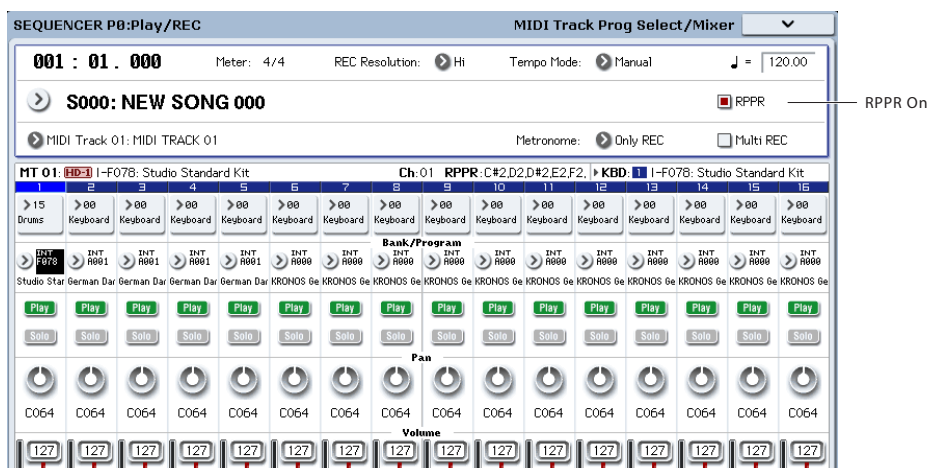

Assign	Bank	Pattern Name	Track Name	Mode	Shift	Sync	Info.
C#2	Preset	P001: Pop & Ballad 1 [All]	T01: MIDI TRACK 01	Manual	+00	SEQ	I-F078: Studio Standar
D2	Preset	P002: Pop & Ballad 2 [All]	T01: MIDI TRACK 01	Manual	+00	SEQ	I-F078: Studio Standar
D#2	Preset	P003: Pop & Ballad 3 [All]	T01: MIDI TRACK 01	Manual	+00	SEQ	I-F078: Studio Standar

“Track Name,” select MIDI track 1 (T01) to which you assigned a drum program.

- For each RPPR pattern, set “Sync” to SEQ (See the diagram above).

With a setting of SEQ, patterns played by the RPPR function while the sequencer is playing or recording will start in synchronization with the measures of the sequencer.

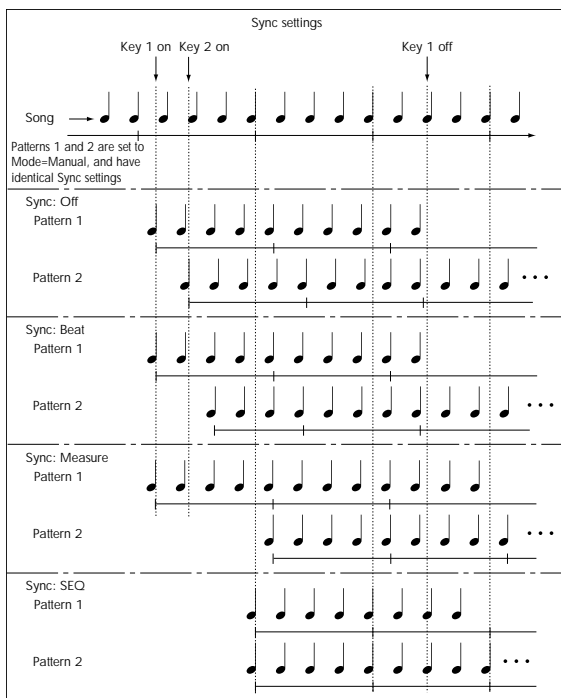

- Select the P0: Play/REC– MIDI Track Prog Select/Mixer page.
- Check the “RPPR” check box, and set “Track Select” to MIDI Track 02.

When the RPPR function is on, pressing a key to which a pattern is assigned will cause the assigned pattern to start playing, regardless of the track that’s selected in “Track Select.”

Keys to which patterns are not assigned can be played in the usual way. You can play the program that’s assigned to the MIDI track you select here.

- Since you want the tracks you play via RPPR and the track you play from the keyboard to be recorded at the same time, check the Multi REC check box.

*Note:* If Recording Setup is set to “Loop All Tracks,” it will not be possible to select Multi REC. Set the Recording Setup to Overwrite.

- Press the SEQUENCER REC/WRITE switch to enter record-ready mode.
- For the tracks you will be recording (MIDI Track 1, 2), press Play/Rec/Mute to make them indicate REC. Make sure that the tracks you’re not recording are indicated as Play or Mute.
- Press the LOCATE switch to set the location to 001:01.000.
- Press the SEQUENCER START/STOP switch, and then press a key that plays an RPPR pattern.

If, during the pre-count before recording, you press a key that’s assigned to an RPPR pattern, the pattern will begin playing (and being recorded) the moment that recording begins.

Record the RPPR pattern playback and keyboard performance.

When recording the playback of patterns triggered by RPPR, the timing of the recorded events may be slightly skewed. If this occurs, try setting “REC Resolution” to a setting other than Hi.

- When you are finished performing, press the SEQUENCER START/STOP switch.

Recording will end, and the sequencer will return to the location at which recording began.

If you made a mistake during your performance or would like to re-record, you can use the Compare function (press the COMPARE switch) to re-record as many times as you wish.

- If you want to record other tracks, un-check the Multi REC (See step 5) or “RPPR” (See step 4) check boxes as necessary.

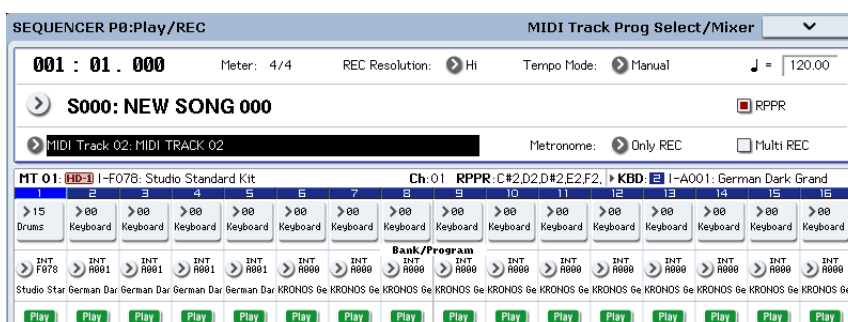

## Sampling in Sequencer mode

Sampling is still available in Sequencer mode - which can be very convenient. The main areas of functionality are summarized below. For more information, see “Sampling in Sequencer mode” on page 159.

- Multisample etc. you create can be played back in Sequencer mode together with internal programs.
- Time Slice (in Sampling mode) lets you divide up a rhythm loop sample, and create playback data that triggers the divided samples at the appropriate timing. You can play back this performance data in Sequencer mode, and adjust the playback tempo without affecting the pitch of the rhythm loop sample. You can even exchange the note numbers of the performance data or change its timing to transform the original rhythm loop sample into a completely new rhythm loop.
- In-Track Sampling lets you sample an external audio source that’s playing along with the song, and automatically create note data in the track to play this sample at the correct time.
- You can resample your completed songs to WAVE files, and create an audio CD by burning those WAVE files in Disk mode.

## Saving your Song

This section explains how to save your song on the internal disk.

To ensure that your data will be reproduced perfectly, we recommend that you use **Save All** to save your song. This saves your sounds, samples, and Song at the same time, with names to tie them together:

- Programs, Combinations, global settings, Drum Kits, Wave Sequences, user Drum Track patterns, and Set Lists
- Songs, including any audio data
- Sampling Mode Multisamples and samples
- Links to loaded EXs and User Sample Bank data

*Note:* WAVE files created by recording audio tracks will be moved to a different directory. For details, see “How audio data is stored on the disk” on page 96.

- ⚠ When you turn off the power, the Sequencer mode settings, recorded songs, and user patterns will be lost. User drum patterns will be retained, however.

To save your data, proceed as follows.

1. **Make sure that the media is able to save data. (“Setting up media”)**
2. **Press the DISK button to enter Disk mode.**
3. **Select the Disk-Save page by pressing the File tab, and then the Save tab.**
4. **Make sure that “Drive Select” is set to HDD:INTERNAL HD.**
5. **If the drive contains directories, select the directory in which you want to save the data.**

Press the Open button to move to a lower level of the directory structure, or the Up button to move to a higher level.

If you want to create a new directory, move to the level at which you want to create the directory, and execute the Utility page menu command “Create Directory.”

6. **Press the page menu button to open the page menu, and select “Save All.”**

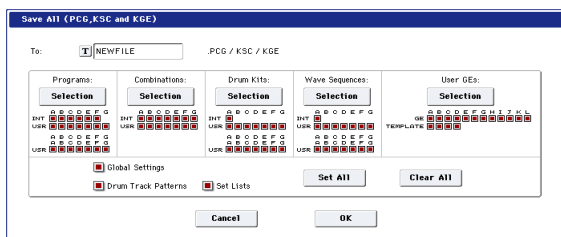

7. **Use the text edit button to enter a filename.**
8. **Press the OK button to start the Save operation.**
9. **When saving is complete and you return to the Save page, the LCD screen will show the resulting files.**

For more details, see “Saving memory contents to disk” on page 197.

## Other notes about Sequencer mode

### KRONOS sequencer file formats

The KRONOS sequencer supports both the internal KRONOS Song format, and Standard MIDI Files.

If you like, you can convert data between the two formats, simply by loading the data in one format and then saving it in the other.

For more information, see “Save to Standard MIDI File” on page 849 of the Parameter Guide, and “Save SEQ” on page 847 of the Parameter Guide.

#### KRONOS Song format

This is the native KRONOS sequencer format, which is required to ensure that all KRONOS-specific data is saved correctly.

#### Standard MIDI Files

You can also load and save Standard MIDI Files (SMF), for compatibility with other sequencers. Note that some KRONOS-specific data may not be maintained when in SMF files.

#### GM, XG, and GS System Exclusive Data

The KRONOS sequencer can record System Exclusive messages, including XG or GS data. For more information, see “System Exclusive events supported in Sequencer mode” on page 663 of the Parameter Guide.

## The Compare function

When you perform realtime recording, step recording, or track editing, this function allows you to make before-and-after comparisons.

If you continue editing when the COMPARE switch is lit, the key will go dark. This now becomes the musical data that will be selected when the COMPARE switch is dark. Any previous unsaved edits will be lost.

#### Operations for which Compare is available

In general, MIDI track, audio track and pattern event data can not be returned to its original state.

Comparing song parameters is possible only during song editing (when executing a page menu command).

- Recording to a MIDI track
- Recording to a audio track
- Track Edit

All commands except for the page menu commands “Memory Status,” “FF/REW Speed” and “Set Location” of the P4: Track Edit– Track Edit page.

- Recording to a pattern
- Pattern Edit

 Note that GM, XG, and GS exclusive messages do not affect the KRONOS when they are played back.

### OASYS Song Format

The KRONOS sequencer can load and play the OASYS song format, with the following caveats:

- The KRONOS preloaded Programs are not the same as those of the OASYS. Please load the PCG file saved with the Song.
- The resolution of the KRONOS sequencer is higher than that of the OASYS (480 ppq vs. 192 ppq). Playback timing may be subtly different.
- Audio directory names must be edited slightly. OASYS files were limited to 8 characters, and so the name of the audio file directory was typically abbreviated. For instance, if the .SNG file was named WAMAZART.SNG, the OASYS audio folder would be named WAMOZA\_A.

The KRONOS supports long file names, and expects to see the entire .SNG name in the audio folder name. Before you load an OASYS .SNG file, edit the name of the audio directory so that it matches the KRONOS standard: the same name as the .SNG file, followed by “\_A” (for “Audio”). In the case above, you’d rename “WAMOZA\_A” to “WAMAZART\_A.”

All commands except for the page menu commands “Memory Status” and “FF/REW Speed” of the P5: Pattern/RPPR– Pattern Edit page.

- Song Edit
  - P0–P3 and P7–P9 pages: Page menu commands “Delete Song” and “Copy From Song”

### Comparing after sampling

The **Convert to Program** and **Convert to Seq Event** options in the **Select Sample No.** dialog affect the way that Compare works with sampling in Sequencer mode. If both are enabled, Compare affects sequencer events and returns Multisamples and Samples to the state prior to sampling; unwanted samples will not remain. If neither are enabled, Compare has no effect on the sampling process.

For more information, see “Select Sample No.” on page 631 of the Parameter Guide.

 The Program will not be affected by the Compare, and will not return to its prior state.

 WAVE files are not deleted when you compare edits to audio tracks. To delete a WAVE file you no longer need, use the menu command “Delete Unused WAV Files,” as described on page 852 of the Parameter Guide.



### Operations for which Compare is not available

- Editing song parameters

- Page menu commands other than those listed under “Operations for which Compare is available,” above.

---

## Memory Protect

Before you record a track or pattern, or edit the musical data, you will need to turn off the memory protect setting in Global mode. For more information, see “Memory protect” on page 195.

---

## About MIDI

### Track status

You can specify whether each track will use the internal KRONOS sounds, or use an external MIDI tone generator.

When the Track **Status** (P2– MIDI page) is set to INT or BTH, operating KRONOS’s keyboard and controllers will sound and control KRONOS’s own tone generator.

When **Status** is set to EXT, EX2 or BTH, operating KRONOS’s keyboard and controllers will sound and control the external tone generator. (The MIDI channel of the external tone generator must match the **MIDI Channel** of the track that is set to EXT, EX2 or BTH.)

1	2	3	4	5	6	7	8
Keyboard	Keyboard	Keyboard	Keyboard	Keyboard	Keyboard	Keyboard	Keyboard
INT	INT	INT	INT	BTH	EXT	EX2	BTH
01	02	03	04	05	06	07	08
000	000	000	000	000	000	000	000
000	000	000	000	000	000	001	000

If you wish to use the Sequencer mode of the instrument as a 16-track multi-timbral tone generator, select INT or BTH. For more information, see “Status” on page 567 of the Parameter Guide.

---

### Synchronizing the sequencer with an external MIDI device

The record/playback tempo of KRONOS’s sequencer can be synchronized to an external MIDI device such as a sequencer or rhythm machine. For more information, see “Synchronizing the playback of KARMA or sequencer” on page 1142 of the Parameter Guide.

# Set Lists

## Set List Overview

Set Lists make it simple to play and organize any of the sounds loaded into the KRONOS, without regard for what bank they're stored in or whether they're Programs, Combinations, or even Songs.

Large on-screen buttons with selectable colors make sound selection fast and foolproof, and the Program Up or Down footswitch assignments can be used for hands-free sound changes. Cut, copy, paste, and insert tools make re-ordering a snap.

Smooth Sound Transitions (SST) let the previous sound and its effects ring out naturally, making it easy to change sounds during a live performance. SST is active in all of the KRONOS modes, but Set Lists give you greater control over the transitions. You can fine-tune the ring-out time for each sound, so that (for instance) one sound fades out very quickly, while another sound's delays continue to repeat for ten or twenty seconds.

Long comments (up to 512 characters) let you store lyrics or performance notes with the sound.

Set Lists are great for live performance, but they're also handy for organizing sounds in general. For example, you can create a Set List with all of your favorite String sounds, including both Programs and Combinations.

---

## Set Lists and Slots

A Set List has 128 Slots, each of which can be assigned to any Program, Combination, or Song. 4, 8, or 16 Slots are shown at once, as large on-screen buttons. You can have 128 Set Lists in memory at once. One way of thinking about this is that a Set List is a "bank" of Slots.

## Selecting and playing sounds

Set List Play page

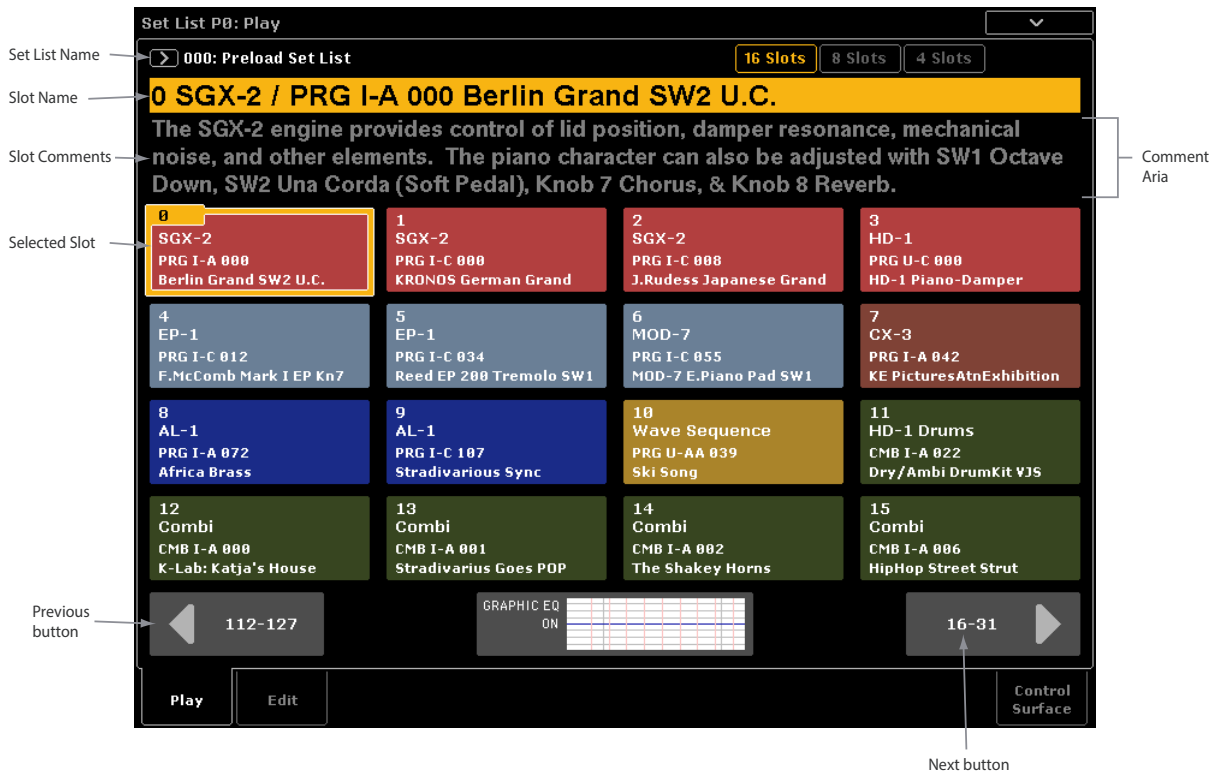

## Selecting Set Lists

The large name in the Set List display is the name of the current Slot, so that you can easily see the sound that you're playing. The Set List name is in smaller text at the top left-hand corner of the screen.

### Selecting with the front-panel buttons

You can select Set Lists using the front-panel buttons, without touching the screen. To do so:

1. Press the **SET LIST** button to enter Set List mode.
2. Press the **Play** tab to go to the Set List P0: Play page.

The main Play page shows the Slot buttons, the comments for the current Slot, and an overview of the EQ.

3. Touch the Set List name to select it.

The Set List name will become highlighted.

4. Use the **VALUE** controllers to select the desired Set List.

You can do any of the following:

- Turn the **Value** dial.
- Press the **Inc**  $\wedge$  or **Dec**  $\vee$  buttons.
- Use the numeric keypad [0]–[9] to specify the number, and press the **ENTER** key.

The **VALUE** slider is reserved for modulation, and sends CC#18 when the Slot contains a Program or Combination.

Once you've selected a Set List, you can select Slots within the list. For more information, see "Selecting Slots," below.

### Selecting via the touch-screen

You can select Set Lists from an on-screen list, as well.

1. Press the **Set List** popup button (to the left of the Set List name).

The Set List Select dialog appears.

2. Press one of the names in the list to select a Set List.

The selected Set List will be highlighted, and the keyboard will immediately switch to the first Slot in the Set List.

3. If you like, play a few notes to hear the sound of the first Slot in the Set List.
4. When you are satisfied with the selected Set List, press the **OK** button to close the popup menu.

Alternately, you can press the **Cancel** button to return to the previously selected Set List.

## Selecting Slots

### 16/8/4 buttons

These buttons, at the top of the display, select how many Slots are shown at once. Smaller numbers of Slots leave more room to show the Comments; larger numbers let you select between more Slots without switching screens. You can change between these settings at any time, as convenient, and the setting is stored with the Set List.

### Selecting within the current group of Slots

To select one of the Slots shown on the display:

#### 1. Press the desired button.

The button becomes highlighted, and the large Slot number/name at the top of the screen are updated accordingly.

Also notice that the comments area, above the Slot buttons, updates to show the contents for the selected Slot. You can view the comments in this position above the Slots, or dedicate the entire screen to showing the comments; for more information, see “Using the Comment Pad” on page 122.

### Selecting outside the current group of Slots

To select a Slot which is not shown on the display:

#### 1. Use the next and previous arrow-buttons at the bottom of the screen to browse through the groups of 16.

The labels for next/previous will vary depending on the current group of Slots, and on the number of Slots being shown. For instance, if 16 Slots are being shown and the current group is 0-15, the buttons will show 112-127 and 16-31, respectively.

As you browse, the current selection does not change until you actually press one of the Slot buttons.

#### 2. When the desired group of Slots is displayed, press the button for the desired Slot.

The button becomes highlighted, and the comments and large Slot number/name at the top of the screen are updated accordingly.

### Selecting using data entry controls

In addition to using the touch-screen buttons, you can select Set List and Slots using the standard data entry controls, including the numeric keypad, rotary encoder, and Inc/Dec.

The VALUE slider is reserved for modulation, and sends CC#18 when the Slot contains a Program or Combination.

### Returning to the current group of Slots

If you have navigated away from the current group of Slots, you can return easily:

- Touch the name of the current item, at the top of the screen (e.g. “SGX-2/PRG I-A000 KRONOS German Grand”).

The display changes to show the group of Slots containing the current selection.

### Stepping through Slots in order

In addition to selecting Slots via the on-screen buttons, you can use Inc/Dec or a footswitch assigned to Program Up or Program Down to step through the Slots in order, one by one.

#### Selecting with Inc/Dec

##### 1. Touch one of the on-screen Slot buttons.

Once a Slot is selected, you can use the Inc and Dec buttons to step through the list of sounds.

If you’re on the last Slot on the current page, pressing Inc will advance you to the first Slot of the next group.

#### Program Up/Down footswitch

The Program Up (or Program Down) footswitch always steps through the list, regardless of whether or not one of the buttons has the UI focus.

The assignable footswitch can be assigned to Program Up or Program Down on the Global mode Controllers page.

#### Wrapping between Set Lists

Inc/Dec and Program Up/Down wrap between Set Lists. For instance:

1. Select Slot 127 in Set List 5.
2. Press Inc, or the Program Up footswitch.

Slot 0 of Set List 6 is selected.

If you’ve edited any Slots in the Set List, a dialog will appear prompting you to save your changes before proceeding. Otherwise, your edits will be lost when the new Set List is selected. For more information, see “Save Changes before changing Set List: a confirmation dialog” on page 122.

### Selecting Slots and Set Lists via MIDI

#### MIDI In

Program Change messages on the Global Channel select the Slot, and Bank Select messages on the Global Channel select the Set List.

When a Slot is selected via MIDI, the display updates if necessary to show the appropriate group of Slots.

#### MIDI Out

Selecting a Slot sends Program Change and Bank Select messages, as above.

When selected, Combinations and Songs can transmit other Program Change and Bank Select messages on other channels, as they do in Combination and Sequencer modes.

#### Global P0 Bank Map

The Global P0 **Bank Map** (Korg, GM(2)) parameter does not affect the reception or transmission of Set List Program and Bank Select messages.

## Save Changes before changing Set List: a confirmation dialog

If you have edited a Set List, and then do something that would select a different Set List (including directly changing the Set List, or wrapping between Set Lists by changing the Slot), a confirmation dialog will appear. The dialog offers the option of saving or discarding the edits.

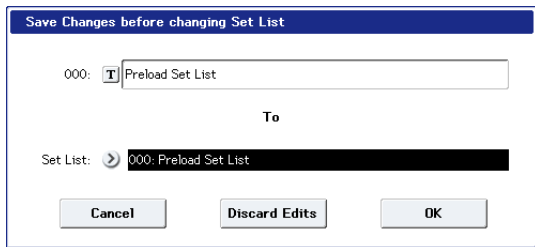

### Saving your edits

If you want to save your edits:

1. Use the [T] Text Edit button to set the name, as desired.

If a USB QWERTY keyboard is connected, you can use this to enter text instead of the on-screen keyboard.

2. Select the location to save to using the To Set List parameter.
3. Press the OK button to save the changes.

The changes will be saved to the specified location, and the Set List change will proceed.

### Discarding edits

If you do not want to save your edits, and just want to proceed to the new Set List:

1. Press the Discard Edits button.

### Canceling the Set List change

If you want to review your edits, and not proceed to the new Set List:

1. Press the Cancel button.

## Using the Comment Pad

The Comment Pad devotes the entire screen to the comment text—convenient for viewing lyrics or longer notes, especially with larger font sizes.

To show the Comment Pad:

1. Touch the comment area and drag down.

When you touch the comment area, a downward arrow appears as a hint that this is available.

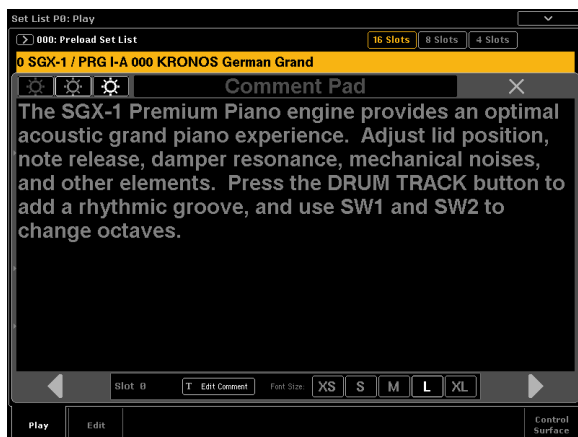

To close the Comment Pad:

1. Press the large X in the upper right corner of the window, or press the EXIT button.

To adjust the brightness of the text:

1. Use the three brightness icons in the upper left corner of the window.

To adjust the size of the font:

1. Use the XS/S/M/L/XL buttons at the bottom of the Window.

This setting mirrors the Slot's Font parameter.

## Editing Set Lists

Set List Edit page

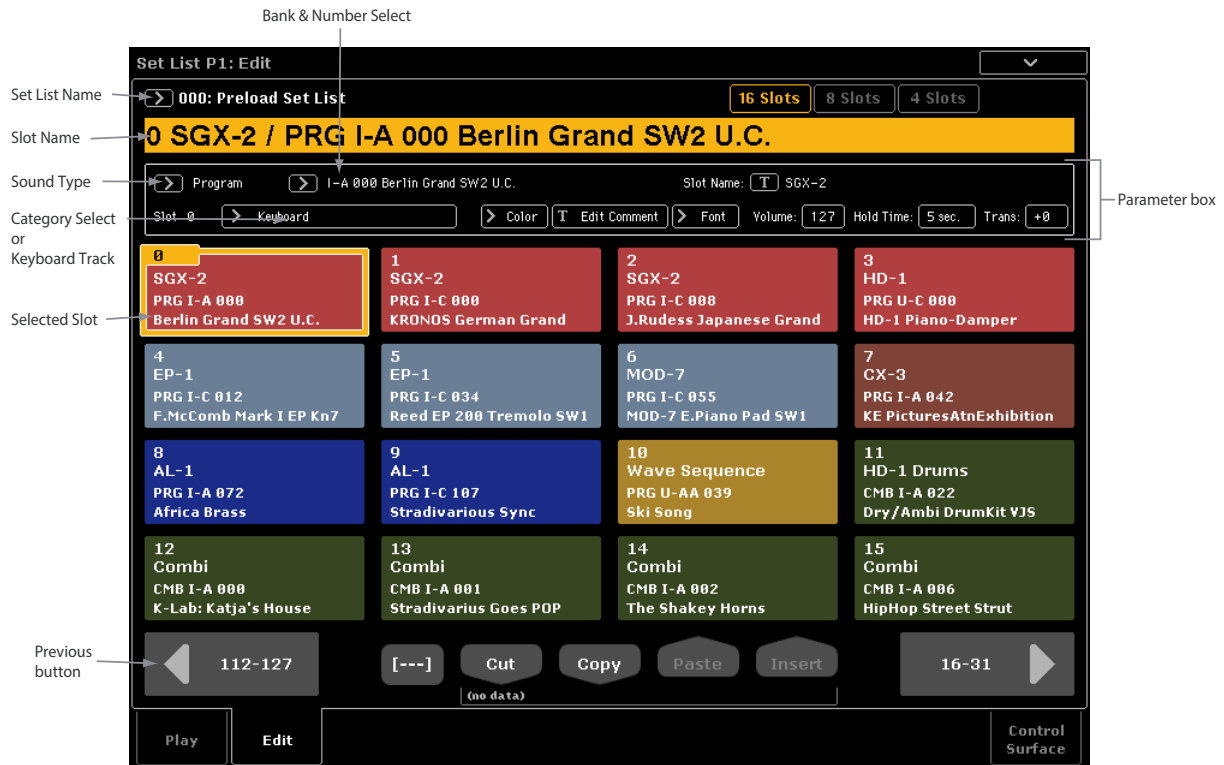

### Overview

For each Slot, you can:

- Assign any Program, Combination, or Song
- Name the Slot
- Enter a text comment (such as lyrics or performance notes), which is shown when the Slot is selected on the main screen

- Customize the appearance of the Slot, including the color and comment font size
- Set the volume, hold time, transposition, and keyboard track (for Songs).

You can also easily rearrange the Slots using the Cut, Copy, Paste, and Insert buttons.

## Selecting and re-arranging sounds

### Choosing a sound for a Slot

1. Go to the Set List Edit page.
2. Select the Slot that you'd like to edit.

Notice the parameters which appear above the Slot buttons. These let you set up the current Slot.

3. At the top left of the parameter box, select the desired Type: Program, Combination, or Song.

Each Slot can play either a Program, a Combination, or a Song. When you change the Type, the **Bank & Number** and **Category** or **Track** parameters will update accordingly.

**Category** appears for Programs and Combinations;  
**Keyboard Track** appears for Songs.

4. Using either the **Bank & Number** or **Category** pop-up menus, select the desired **Program, Combination, or Song**.

For more information, see “Selecting by bank and number” on page 32, “Selecting by Category” on page 33, and “Song Select” on page 518 of the Parameter Guide.

Note that you can use the same sound in multiple Slots within the same Set List. For instance, you might have a favorite piano sound which you use in a number of different songs. You can create any number of Slots which use this same piano sound, each with different names and comments.

### Setting the MIDI Track for Songs

With Songs, you can assign the local keyboard to play any of the 16 MIDI Tracks. If you like, you can have the same Song in multiple Slots, each with a different Track. You can then switch between the Slots, changing the sound assigned to the keyboard, as the Song continues to play.

This parameter applies to Songs only. If the current Slot is a Program or Combination, it does not appear.

---

### Adding items to the Set List from other modes

Program, Combination, and Sequencer modes each have a command in their P0 page menus: **Add To Set List**. This makes it easy to browse through sounds and place them in Set Lists as you go. To do so:

1. Choose “Add To Set List” to open the dialog box.
2. Use the “Set List” and “Insert Slot” parameters to select the destination Set List and Slot.

By default, these are set to the current Set List and Slot. If you select something other than the current Set List and Slot, the **Revert To Current** button will be enabled; press this button to return the parameters to the current Set List and Slot.

3. Use the text popup to set the Slot Name as desired.

The name of the Program, Combination, or Song is copied into the slot name by default.

4. Press **OK** to add the Program, Combination, or Song to the Set List, or press **Cancel** to exit without making changes.

When you press **OK**, the current Program, Combination, or Song is inserted at the selected Slot, using the same logic as the Set List Edit page’s **Insert** command.

When adding a Song, the current Keyboard Track is copied into the slot’s Keyboard Track parameter.

---

### Re-arranging Slots

The **Cut**, **Copy**, **Paste**, and **Insert** buttons make it simple to re-arrange the Slots, and the [---] button (the Multiple Slot Selection tool) lets you select two or more Slots at once.

#### Using the [---] button to select a range of Slots

To select a range of slots with the [---] button:

1. Select the Slot at one end of the desired range of slots (either the first or the last).
2. Press the [---] button.

---

## Detailed Set List editing

---

### Naming a Slot

You can name a Slot separately from the name of the Program, Combination, or Song it contains. For instance, if you’re creating a Set List for a gig, you can name the Slots after the section of music in which they’re used, such as “Montana Intro.” To do so:

1. Press the “T” button to bring up the text edit dialog.
2. Enter the name as desired, and then press **OK**.

Slot names can have up to 24 characters.

---

### Controlling Slot volume

You can control the volume separately for each Slot. For instance, you might set the volume softer for a Slot playing an accompaniment part, and louder for a Slot with a lead sound. To do so:

Notice that the selected Slot now has a different highlight color.

3. Select the Slot at the other end of the desired range.

Once the desired range is selected, use the **Cut/Copy/Paste/Insert** buttons, as described below, to operate on the Slots. The selected range is also used by the **Color** and **Font** dialog boxes, so that you can edit multiple Slots at once.

#### Copying a Slot to another location

To copy one Slot to another (for instance, if you have a sound that you’d like to use in multiple Slots):

1. Select the Slot you’d like to copy.
2. Press the **Copy** button.
3. Select the Slot you’d like to replace.
4. Press the **Paste** button.

The selected Slot will be replaced by the copied Slot.

#### Inserting Slots into the middle of a Set List

You can also insert copied Slots into the middle of a Set List, while leaving the rest of the list intact. To do this:

1. Select the Slots you’d like to copy.
2. Press the **Copy** button.
3. Select the Slot to specify the insert point.

The copied Slot(s) will be placed in front of the selected Slot, and the rest of the Set List will move to make room.

4. Press the **Insert** button.

#### Removing Slots from a Set List

You can remove Slots from the middle of a Set List, while leaving the rest of the list intact. To do so:

1. Select the Slots you’d like to remove.
2. Press the **Cut** button.

This removes the Slots from the list, and moves the rest of the list to fill in the now-empty space.

If you like, you can **Paste** or **Insert** the Slots that were removed via **Cut**, similar to the **Copy** operations described above.

1. Adjust the **Volume** parameter.

Note that the stored **Master Volume** setting of the Slot’s Program, Combination, or Song still applies as well. You can edit this from the **Control Surface**, if desired.

See the graphic below for details on how the Set List volume interacts with other volume controls.



Set List Slot Volume

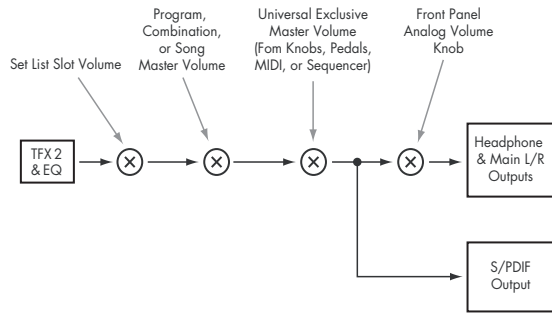

Transposing individual Slots

You can adjust transposition separately for each Slot. For instance, you might decide to transpose a song down by a few half-steps to accommodate a singer. To do so:

1. Adjust the Transpose parameter.

This sets the transposition of the current slot, in semitones.

Drums not affected by Slot Transpose

Slot Transpose is designed so that, in general, it doesn't affect un-pitched drum sounds unless they're being played directly from the keyboard.

If the Slot contains a Program, its Drum Track Program is not affected by Transpose.

Similarly, if the Slot contains a Combination or Song, drums played by the Drum Track or generated as part of KARMA rhythms are generally excluded from Transposition. To achieve this, Timbres or Tracks are not affected by Transpose if both of the following are true:

- The MIDI Channel is not the same as the Global Channel (for Combis) or the selected Keyboard Track (for Songs), and...
- The Program's Category is "Drums," except for the sub-category "Pitched" (used for timpani, for instance)

Entering comments

Each Slot can have a comment of up to 512 characters, for lyrics, performance notes, and so on. To edit the comments:

1. Press the Edit Comment button to bring up the text edit dialog box.

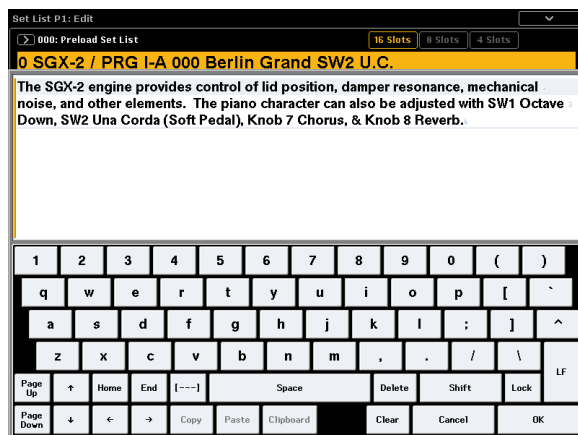

The comment edit dialog box has a few added features in comparison to the standard text editor:

- Text is displayed using the Slot's selected font.
- Use touch-drag to select text.
- Use the LF button to insert line feeds (aka "returns").
- Multiple cut/copy clipboards are supported; see below for details.

If a USB QWERTY keyboard is connected, you can use this to enter text instead of the on-screen keyboard. For more information, see "Editing names and entering text" on page 193.

2. Enter the comment as desired, and then press OK.

You can read the entire comment, even with multiple lines, on the Set List Play page.

Multiple clipboards in the Comment editor

After copying or cutting text in the Comment editor, press the Clipboard button to show the current contents of the clipboards. Each clipboard is represented by a button with an abbreviation of the text it contains. 10 clipboards can be retained at once. If an eleventh section of text is copied, the oldest clipboard is discarded.

Touch the buttons to paste the text into the comment. (The separate Paste button always pastes the most recent clipboard.) To remove a clipboard, enable its Remove checkbox and then press the Remove button.

Setting the Slot's color

You can assign each Slot to one of 16 different colors, to make it easier to distinguish between them quickly. You can also apply a color to a range of Slots at once. To do so:

1. Press the Color button to bring up the color selection dialog box.

2. Choose a color for the Slot.

If you like, you can also select a range of Slots, and apply a color to all of them at once.

3. When you're done, press OK.

Legacy Slot Style

If you prefer the graphical appearance of Set Lists prior to KRONOS software version 3.0, you can enable the Legacy Slot Style option in the menu. This removes the bold outline from the selected Slot (coloring it bright orange instead), and uses the same gray color for all other Slots, ignoring the Slot Color settings.

Saving your edits

Once you've made a Set List, you'll want to save your work. To do so:

1. Select the Write Set List command from the page menu, at the upper right-hand corner of the screen.

You can also call up this menu command by holding ENTER and pressing 0 on the numeric keypad.

This brings up a dialog box which allows you to save the Set List. Optionally, you can also select a new location, or change the Set List's name.

2. Press the "T" button to bring up the text edit dialog.

You can give the Set List a descriptive name using the on-screen keyboard.

**3. After entering the name, press OK.**

The text edit window will disappear, returning you to the main Write dialog.

**4. Under “To” at the bottom of the dialog, press the popup button next to Set List to bring up the save location dialog.**

**5. Select a location to save the edited Set List.**

**6. After selecting the location, press OK.**

**7. Press OK again to start the write process.**

**8. If you’re sure you want to write to this location, press OK again.**

After that, you’re done!

 Do not turn off the power for at least 10 seconds after writing the Set List data. This allows the system time to complete the process, which includes saving a backup of the data to the internal disk.

---

## Editing a Slot’s Program, Combination, or Song

When you’re in a rehearsal or sound-check, you may need to make quick edits to a sound in the Set List.

With this in mind, you can:

- Jump to the editing pages for the selected Program, Combination, or Song
- Make the desired edits

---

## Set Lists and the Control Surface

### Overview

The Control Surface is the group of knobs, buttons, and sliders to the left of the display. You can use it for hands-on control of mixing, KARMA, and external devices, as well as synth modulation and editing. It’s a pretty deep and powerful part of the KRONOS; for an in-depth look at some of what it can do, see “Quick edits using the knobs, sliders, and switches” on page 43.

In this part of the manual, we’ll just look at the unique ways that the Control Surface works in Set List mode.

In general, the Control Surface works very similarly for Program, Combination, and Songs. However, there are some small differences between them, matching their different capabilities. For instance, Programs have three mixer channels (for the two oscillators or EXi, plus Drum Track), while Combinations and Songs have sixteen channels. The Set List’s Control Surface page will change to match the current Slot type.

For more information on how the Control Surface works in the different modes, see:

**Programs:** “Control Surface knobs, sliders, & switches” on page 37, and “Quick edits using the knobs, sliders, and switches” on page 43

**Combinations:** “Adjusting the mix” on page 66, “Easy KARMA editing” on page 67, and “Editing Programs with Tone Adjust” on page 72

- Save the edits
- Return easily to the original Set List page

To do so:

**1. Select the desired item in the Set List.**

Next, from any of the Set List pages:

**2a. In the menu, select the Edit [Type] command.**

The actual name of the command will be either **Edit Program**, **Edit Combination**, or **Edit Song**, depending on the selected Slot.

or:

**2b. Hold the front-panel ENTER button, and touch the Slot’s button.**

The mode will change to Program, Combination, or Sequence as appropriate, and the system will display the P0 page for the selected item.

The Program, Combination, or Sequence mode button’s LED will blink, and the Set List LED remains solidly on, to show that you are editing an item in a Set List. The Set List settings, including EQ and volume, continue to affect the sound.

**3. Edit as desired.**

**4. Write your edits.**

For more information, see “Saving your edits” on page 46 (for Programs), “Saving your edits” on page 74 (for Combinations), or “Saving your Song” on page 116.

**5. Press the SET LIST button to return to the Set List.**

Set List mode will be as you left it, with the same Set List and Slot selected.

**Songs (Sequencer mode):** “The control surface in Sequencer mode” on page 80

### Most Control Surface edits not stored in the Set List

**Important:** Only the Graphic EQ settings are stored with the Set List. All other Control Surface edits are not stored with the Set List. Instead, they must be stored with the original Program, Combination, or Song. For more details, see “Saving Control Surface edits,” below.

---

### Saving Control Surface edits

Any changes that you make via the Control Surface—editing mixer levels, for instance, or tweaking the real-time knobs—are temporary unless they are saved, just as they are in the other modes.

However, if you make changes that you’d like to keep, you can save your edits to Programs or Combinations directly from Set List mode. To do so:

**1. Make your edits using the Control Surface.**

**2. In the page menu, select the command “Update Program” or “Update Combination.”**

The actual name will depend on whether the current Slot is a Program or Combination.

Songs work slightly differently, since they don't have a Write command (and must be saved to disk). All edits made in Set List mode apply directly to the Songs in memory, and can be saved to disk as desired.

### Using the Control Assign From setting

The Control Assign setting determines the functions assigned to the Control Surface, such as the mixer, Tone Adjust, KARMA and Real-Time Knobs, and so on.

**Control Assign From** sets whether the Control Assign applies to the Set List as a whole, and stays the same regardless of which Slot is selected, or instead changes according to the saved value for the Program, Combination, or Song in the current Slot.

For instance, you may wish to have the Control Surface stay assigned to the Set List EQ all the time. In this case, set **Control Assign From to Set List**.

Or, you may wish to have the Control Surface update to match the current Program, Combination, or Song. For instance, you might want to use Tone Adjust for drawbars on an organ Program, and then on the next Slot use the sliders to control KARMA in a Combination. In that case, set **Control Assign From to Slot**.

Similar to the Timbre/Track and Audio buttons, the setting is indicated by LEDs to the right of the button. To set the Control Surface to control the Graphic EQ:

1. Press the **TONE ADJ/EQ** button until the **EQ** button is lit.

If you press another Control Assign button, and then press TONE ADJ/EQ again, the Control Surface returns to the function last selected for the button. For instance, if you last used it for EQ, then EQ will be selected.

As a shortcut, you can also touch the EQ graphic on the Set List Play page. This will jump to the Control Surface page, and set Control Assign to EQ.

### Reset Controls

When on the EQ page, **RESET CONTROLS + TONE ADJ/EQ** resets all EQ parameters, including Bypass, to the values stored in the Set List.

**RESET CONTROLS + Slider** resets the slider's band to the stored value.

### Graphic EQ

Set Lists have an additional Control Surface option, not available in the other modes: EQ. This is a nine-band graphic EQ applied to the sound after TFX2, which tailors the sound from the main stereo outputs (including the analog L/R outputs, S/P DIF, and USB).

You can use this EQ to compensate for the acoustic environment of a specific club or other performance venue. The sliders are mapped to the nine bands of the EQ, for quick and intuitive adjustments.

All bands are peaking, including the high and low bands.

There is a single graphic EQ setting for each Set List, which applies to all Slots in the list.



### Using the Control Surface with the Graphic EQ

The last button in the Control Assign section, TONE ADJ, has an additional option in Set List mode; pressing the button toggles the Control Surface between Tone Adjust and EQ.

## Smooth Sound Transitions

### Overview

Smooth Sound Transitions (SST) help to avoid jarring discontinuities when changing between Programs, Combinations, and Songs, by allowing the previous sound and its effects to ring out naturally as you play the newly selected sound. You can even continue to hold notes on the old sound (on the keyboard or with the sustain pedal) as you play the new sound.

SST applies to all modes—not just the Set List. For instance, notes and effects are sustained when changing from one Combination to another in Combination mode, or from a Program (in Program mode) to a Combination (in Combination mode).

There are only two parameters that relate to SST: the Global **Hold Time**, and the **Hold Time** for each Slot in a Set List. Under the hood, though, there's a lot going on. We'll talk about some of this in detail below, but if you're in a hurry, here are the main things that you need to know:

- SST works between two sounds at a time: the current sound and the previous sound. If you select a new sound while two older sounds are still overlapping, the oldest sound stops.
- SST requires that the effects for both the old and new sounds fit into the available processing power. For factory sounds, this should almost never be a problem. In the unlikely event that the effects don't fit, the older sound will be silenced, including all of its notes and effects.
- The **Hold Time** parameters control how long the old sound rings out after all of its notes have been released.
- KARMA and the Drum Track stop when you change sounds. Their notes will continue to ring out naturally.

## Using Smooth Sound Transitions

### Using Hold Time

The KRONOS has two **Hold Time** parameters. As noted above, these control how long the old sound rings out after all of its notes have been released.

One of these parameters is on the Global Basic page, and it controls the hold time for everything outside of the Set List, including Program, Combination, and Sequencer modes. The other, in the Set List Slot parameters, controls the hold time for each individual Slot. Let's look at how this one works.

1. Go to the **Set List Edit** page.
  2. Select **Set List 127**.
- This has been left initialized for your own use.
3. Select **Slot 1**, and set its **Program** to **U-E075 CX3/MS20 Lead Split**.

This sound has a long delay on the lead sound, which will help to demonstrate the effect of **Hold Time**.

4. Set **Slot 1's Hold Time** to **10 seconds**.
5. With **Slot 1** still selected, press the **Copy** button.
6. Select **Slot 3**.

We'll leave Slot 2 set to the default piano sound.

7. Press the **Paste** button.

Slot 3 becomes a copy of Slot 1, with the same Program setting.

8. Set **Slot 3's Hold Time** to **0 seconds**.
9. Play a brief phrase on the lead synth sound on the right-hand side of the keyboard, and then pause to listen.

Notice how the delay repeats for a long time, as the sound gradually fades away. **Hold Time** doesn't affect the sound as long as you stay on the same Slot.

10. Play the phrase again, and this time immediately switch to **Slot 2**.

This time, the sound disappears very quickly. The **Hold Time** comes into play when you change between different sounds. Note that it's the old Slot's **Hold Time** (Slot 3 in this case) that determines the speed of the fade.

Also, notice that even though **Hold Time** is set to 0 seconds, it's still a smooth fade; after the **Hold Time** has elapsed, there's always a half-second or so fade to silence.

11. Select **Slot 1**.

Remember, this Slot's **Hold Time** is set to 10 seconds.

12. Play the phrase again, and immediately switch to **Slot 2**.

Notice how the delay repeats for a long time.

13. Play something briefly on **Slot 2's piano sound**, and then pause to listen.

Notice how the delay from Slot 1 is still fading out, alongside the piano sound.

So, why would you want to change this in the first place? Even though the default of 5 seconds works well to smooth transitions in general, there may be times in live performance when you'd either like the effects and decaying notes to ring out for a long time, or fade away immediately. The per-Slot **Hold Time** gives you this control.

### Hold Time starts after notes are released

The **Hold Time** starts only after you release any notes being played on the old sound. Continuing from the example above:

1. Select **Slot 3**.
2. Play and hold a note on the lead synth sound on the right-hand side of the keyboard.
3. While holding the note, switch to **Slot 2**.

Notice how the note continues to play.

#### 4. After holding the note for a while, release the note.

After you release the note, the **Hold Time** starts, and the sound fades away quickly.

#### Global Hold Time

The Global **Hold Time** parameter is on the Global Basic page. As mentioned above, it controls the hold time for everything outside of the Set List, including Program, Combination, and Sequencer modes. The default setting is 5 seconds, which should work well in most cases, but you can change it if you like.

---

### Stopping sustaining or held notes

Sometimes, you may want to stop sounding voices immediately—for instance, if a sound is set to hold indefinitely. To do so:

1. **Select a different sound, including any Program, Combination, Song, or Set List Slot.**
2. **Select a different sound again.**

For instance, within a Set List with Slot 1 selected, select Slot 2 and then return to Slot 1. Or, on Program A000, press the front-panel **COMBI** button (which selects a Combination) and then press the front-panel **PROG** button (to re-select the previous Program). At the second change, all notes held from the original sound will be stolen.

---

### Other details

#### Controllers

Most controllers (Joystick +/-Y, Aftertouch, real-time knobs, etc.) affect only the new sound, and not the old.

Sustain, Sostenuato, Joystick X (pitch bend), and Note Gate continue to affect the old sound, as well as the new. You can use the Combination and Song MIDI Filters for additional control over these MIDI messages, if desired.

#### Effects

Internally, the KRONOS has two separate sets of effects, like two racks of effects. One of these racks is used by the current sound; the other is used by the previous sound. This allows the two sets of effects to work simultaneously; for instance, the previous sound's delays can continue to ring out while you're playing the new sound.

There are only two of these effects racks, however. Every time that you select a new sound, the older of the two effects racks is silenced and re-configured for the new sound.

Also, it's possible for the combined requirements of the two effects racks to exceed the available processing power. If this happens, the old effects rack is silenced immediately.

*Note:* When the old effects rack is silenced, all of the notes which were playing through it are silenced as well.

#### Limitations

When you select a new sound, the previous sound's KARMA and Drum Track patterns stop. Any notes being played by the Drum Track or KARMA (including those generated by KARMA's Thru In and Thru Out Zones) are released, and then decay normally.

Similarly, the PolysixEX arpeggiator stops playing on sound change.

When editing EXi Programs, changing the EXi model of the current Program will silence any voices from the previous sound. Note that this happens only when actually editing the Program, and not simply when changing from one Program to another.

Resource limitations may prevent the previous sound from ringing out until silence. For instance:

- Notes may be stolen.
- If there is not enough processing power for the old and new effects racks to coexist, both the old effects rack and all old voices will be silenced.



# Sampling (Open Sampling System)

## Sampling overview

### About sampling on the KRONOS

#### Overview

The KRONOS can sample external audio from the analog, S/P DIF, or USB inputs, at 48 kHz 16-bit resolution (or 24-bit when sampling to disk), in mono or stereo. You can record samples into RAM, or sample directly to disk.

You can also digitally resample the complete sound of a Program, Combi, or Song, played live or sequenced, including any effects and KARMA-generated events.

Using an external USB CD drive (not included), you can also sample (or “rip”) directly from an audio CD, in the digital domain.

Finally, you can process the inputs through the IFX, MFX, and TFX, or through the synthesis functions of EXi such as the MS-20EX and MOD-7.

You can combine any and all of these features at once. For instance, you can sample a live guitar riff from the audio inputs, processed through KRONOS effects, while listening to and either recording or not recording a KARMA-generated phrase.

You can use your samples directly in Drum Kits, or make them into Multisamples and use them anywhere that you use ROM Multisamples, such as in HD-1 Programs or Wave Sequences.

#### KSC Files and User Sample Banks

KSC stands for Korg Sample Collection. KSC files group your Samples and Multisamples together, and let you load them as User Sample Banks. User Sample Banks may be loaded either into RAM, or may use Virtual Memory, just like EXs. They have other benefits as well. For more information, see “Creating and saving .KSC files” on page 175.

#### Sampling and RAM

The KRONOS (2014) comes with 3 GB of RAM pre-installed. Approximately 1 GB of this RAM is used by the operating system and ROM sample data. The remainder is shared between the samples in EXs, User Sample Banks, and Sampling Mode.

This means that the size of the currently loaded EXs and User Sample Banks trades off against the memory available for Sampling Mode. The more space used by EXs and User Sample Banks, the less is available for Sampling Mode.

Using Virtual Memory for EXs and User Sample Banks generally lets you load more samples at once, but may still use a substantial amount of RAM.

*Note:* To check the amount of sample RAM available, see “0–1f: Free Sample Memory/Locations” on page 686 of the Parameter Guide.

The amount of sampling time depends on the amount of free RAM, as shown below.

#### Free RAM and approximate sampling times

Free RAM	Approximate Sampling Time (min:sec)	
	Mono	Stereo
16 MB	2:54	1:27
64 MB	11:39	5:49
128 MB	23:18	11:39
256 MB	46:36	23:18
512 MB	93:12	46:36

#### Sampling to disk

You can sample directly to disk (including the internal disk and USB storage devices), creating a WAVE file. This lets you record up to 80 minutes continuously, in either mono or stereo (mono: approximately 440 MB, stereo: approximately 879 MB).

As long as they fit into the available RAM, these WAVE files can then be loaded into Sampling Mode and used in Drum Kits, HD-1 Programs or Wave Sequences. (Note that after loading them into Sampling Mode, you’ll need to save them again; the WAVE files can’t be used directly for Programs, etc.)

WAVE files can also be used in audio tracks of the sequencer, or used to create an audio CD. For more information, see “Audio recording” on page 95, and “Creating and playing audio CDs” on page 206.

- ⚠ Do not turn off the power for at least 10 seconds after sampling to disk. This allows the system time to complete the process.

#### 24-bit sampling to disk

When sampling to disk, you can choose either 16-bit or 24-bit resolution. Both 16- and 24-bit WAVE files can be used directly in Sequencer mode audio tracks. When loaded as RAM samples, 24-bit WAVE files are automatically converted to 16-bit resolution.

#### Sampling in Sampling mode

In Sampling mode, you can sample analog audio from connected microphones or line inputs, or digital audio from S/P DIF or USB. If you like, you can also sample through the KRONOS effects.

You can even sample directly from audio CDs in an external USB CD-R/RW.

Samples can be processed through effects and internally sampled again (“resampled”). You can use either “Auto” mode which automatically applies the specified effect processing to the selected sample, or “Manual” mode which lets you play the sample manually with effects applied and resample your performance.



**Program, Combination, Sequencer modes**

In Program, Combination, and Sequencer modes, you can resample a complete live performance including filters, effects, KARMA, and even sequencer playback.

You can also sample external audio sources, mix the KRONOS sounds with the external audio and sample the combined result, or even monitor the performance of the KRONOS while sampling only the external source.

**In-Track Sampling in Sequencer mode**

In Sequencer mode, you can sample while playing along with a Song, and automatically create note data to trigger the new samples at the appropriate moment in the Song. You can then manipulate these samples using the synthesis abilities of the HD-1, for creative alternatives to HDR. This is called “In-Track Sampling.”

**Sampling frequency and bit resolution**

As shown in the diagram, sampling reads the level of the analog signal at fixed intervals along the time axis, and stores the levels in memory as digital data.

The time between these intervals is called the “sampling frequency.” 48 kHz (kilo Hertz) means that sampling is performed 48,000 times each second, so that the intervals are 1/48,000 of a second apart— approximately 0.02083 ms (milliseconds).

The higher the sampling frequency, the closer to the original analog signal the waveform in memory will be.

Each level is read and converted into digital data. The accuracy of the level measurement is determined by the bit resolution. This process converts an analog signal with infinite resolution into a digital signal with finite resolution. With 16 bit resolution, each level is indicated in 65,536 steps (the sixteenth power of two).

The greater the bit resolution, the closer to the original analog signal the waveform in memory will be.

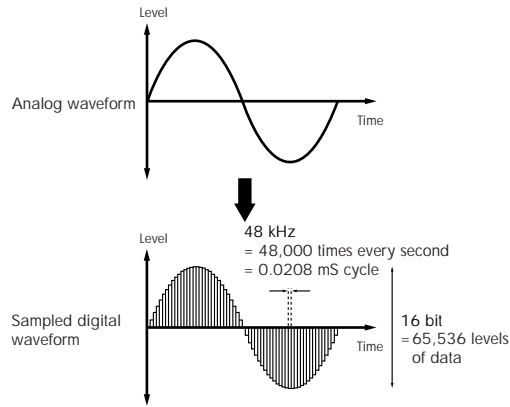

**Samples and Multisamples**

**Samples**

The data that is recorded (sampled) into internal memory or loaded from a file is referred to as a sample or sample file. Samples consist of the actual waveform data, and parameters that specify how the data will be played back, such as Start, Loop Start, and End Address. Samples can be used in multisamples and drum kits.

Sampling Mode supports a maximum of 16,000 Samples at once. Samples in EXs and User Banks do not count towards this maximum.

The KRONOS can share a single waveform among multiple samples. This allows you to create multiple samples with different playback addresses from the same waveform without wasting internal memory. For example, suppose that you have waveform data that records a voice saying “One-Two-Three.” This single piece of waveform data could be shared by three samples, with the playback of sample A producing “One-Two-Three,” sample B producing “One-Two,” and sample C producing “Two-Three.”

For more information, see “Copy” on page 737 of the Parameter Guide.

**Multisamples**

Multisamples lay out one or more Samples across the keyboard. For instance, a very simple guitar Multisample might have six Samples—one for each string.

*Conceptual diagram of the Open Sampling System*

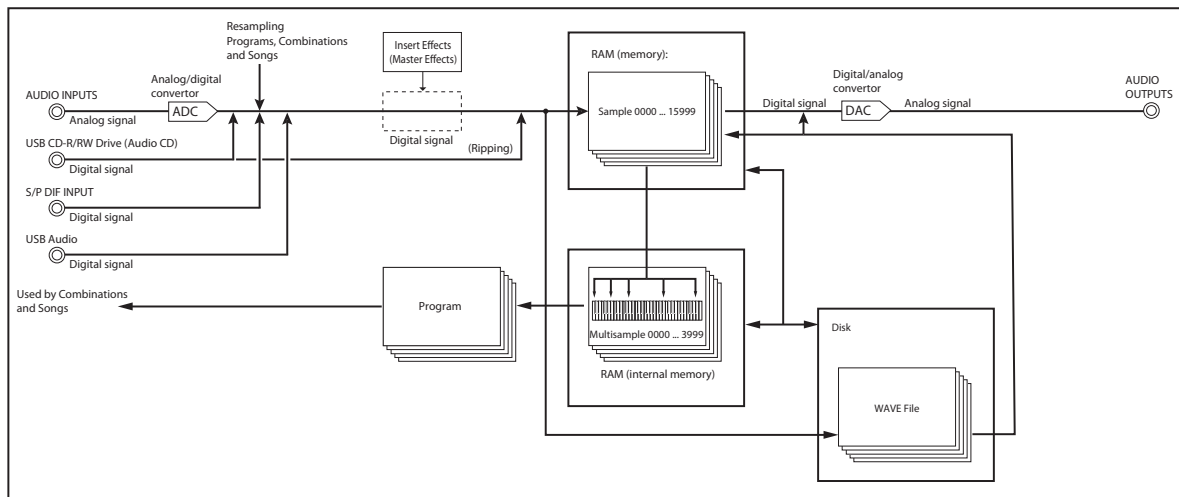

Each Sample is contained in an Index, which includes parameters for the key range, original Sample pitch, tuning, level, and so on.

Multisamples can each have up to 128 Indexes.

**Using multisamples**

When sampling an instrument that is able to produce a wide range of pitches, such as a piano, recording just one sample and applying it (playing it back) over the entire pitch range will not produce a natural-sounding result. By using a multisample you can record separate samples for each pitch range, and assign these samples to their respective pitch ranges to avoid any unnatural sounds during playback.

All of the instrumental sounds in the KRONOS's internal preset multisamples are constructed in this way. For example, you might record one sample per octave, and assign each of these samples to an index covering a one-octave range on the keyboard.

By assigning multiple samples such as phrase samples or rhythm loops to different indexes within a Multisample, you can play multiple samples simultaneously. You can assign different phrases to each key. Alternatively, these samples could be assigned at one-octave intervals, and played as phrase variations with different playback pitches and tempos.

Sampling Mode supports a maximum of 4,000 Multisamples at once. Multisamples in EXs and User Banks do not count towards this maximum.

Multisamples may be used directly in Programs, or within Wave Sequences. They can be used with KARMA to produce interesting results (for example, by using KARMA to automatically play sound effects or spoken samples).

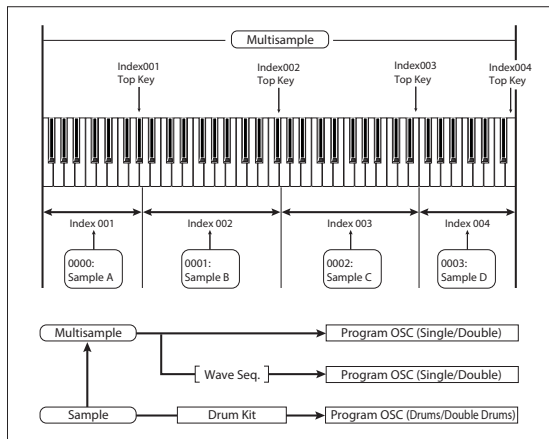

## Preparations for sampling

### Audio Settings

#### Audio input settings

##### The Audio Input page

This page is available in Program, Combination, Sequencer, and Sampling modes, and lets you adjust the volume, pan, effects sends, and bussing for the audio inputs, including analog inputs 1 & 2, USB 1 & 2, and S/P DIF L & R. Outside of Sampling mode, this is the main page for sampling-related settings.

Pages with Audio input settings include:

Mode	Page
Sampling	P0: Recording– Audio Input
Combination	P0: Play– Audio Input/Sampling
Program	P0: Play– Audio Input/Sampling
Sequencer	P0: Play/REC– Audio Input/Sampling
Global	P0: Basic Setup– Audio

##### Using the control surface with the Audio Inputs

You can use the control surface to adjust most of the Audio Input mixer parameters, including **Play/Mute**, **Solo**, **Pan**, **Level**, and **Sends 1 and 2**.

For more information, and “Adjusting volume, Pan, EQ, and FX sends” on page 43.

##### Global audio input settings

Each Program, Combination, and Song can either use the single, Global audio input mixer setup, or have its own custom settings. Sampling mode, on the other hand, has its own, separate settings for the audio inputs.

For Programs, Combinations, and Songs, the choice of whether or not to use the Global setup is controlled by the **Use Global Setting** parameter.

When **Use Global Setting** is **On**, the Program, Combination, or Song uses the Global settings. This is the default, and lets you change freely between different sounds without affecting the audio inputs. Also, any edits made on Audio

Input page will affect the Global setting, along with any other Programs, Combis, or Songs which use the Global setting.

On the other hand, it may sometimes be convenient to save a particular mixer setup with an individual Program, Combi, or Song, to set up special sub-mixer settings or effects processing for particular inputs. For example, you can set up a Program to use a mic input with a vocoder, as described under “Vocoder (Program mode)” on page 863.

In this case, set **Use Global Setting** to **Off**, and the audio inputs will use the Program’s custom settings.

##### Sampling can bypass the mixer entirely

When sampling, you’ll use the **Source Bus** parameter to select the source of the audio to sample. Depending on the selected **Source Bus**, you may or may not need to use the Audio Input mixer at all.

For instance, if you’re sampling through the KRONOS effects, you’ll need to use the Audio Input mixer to send the desired audio input to the effects.

However, if you simply want to sample the input directly, you can just set the **Source Bus** to the desired input, and you’re done—with no need to do any setup in the Audio Input mixer.

### Audio Input mixer

#### Input 1 & 2, USB 1 & 2, S/P DIF L & R

**Input 1 & 2:** These are the analog audio inputs, for either microphones or line-level signals. For more information, see “Analog AUDIO INPUTS” on page 8.

**USB 1 & 2:** These are the USB audio inputs, for sampling from a connected computer.

**S/P DIF L & R:** These are the S/P DIF inputs, for digital audio devices such as instruments, recorders, or effects. The KRONOS supports S/P DIF input and output at 48 kHz.

⚠ When using S/P DIF, make sure that the **System Clock** is set correctly. For more information, see “System Clock” on page 756 of the Parameter Guide.

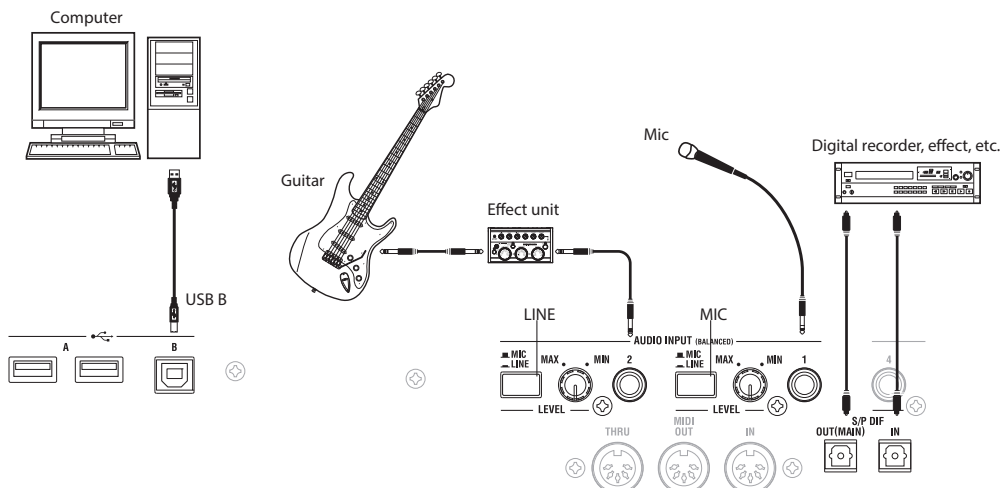

**Bus Select (IFX/Indiv.)**

This sets the output bus for the external audio input signal. You can send the audio directly to physical outputs, or to the insert effects.

**L/R:** The external audio input signal will be sent to the L/R bus. Choose this if you want to sample the performance of the KRONOS itself along with the other signals of the L/R bus. Set **Source Bus** to L/R.

**IFX1...12:** The external audio input signal will be sent to the IFX1–12 bus. Choose one of these settings if you want to apply an insert effect while recording. Set the **Source Bus** to match the **Bus Select** that follows the insert effect.

**1...4:** The external audio input signal will be sent to INDIVIDUAL 1...4 outputs in mono. **Pan** does not apply in this case.

**1/2, 3/4:** The external audio input signal will be sent to the selected pair of outputs in stereo, with the stereo position controlled by the **Pan** parameter. Set **Source Bus** to the corresponding Indiv. input.

**Off:** The external audio signal will not be sent to a bus. In Sampling mode, if you want to sample an external audio signal directly without routing it through a bus, go to the P0: Recording– Audio Input page, and choose the external input you want to sample (Audio Input 1–2, S/P DIF L–R, USB 1–2) as the **Source Bus**.

 Please note that when you change **Bus Select (IFX/Indiv.)** from Off to L/R or IFX, the volume level to the AUDIO OUT L/MONO and R jacks or to the headphones may dramatically increase.

**FX Ctrl Bus (FX Control Bus)**

The FX Control Buses lets you create effects “sidechains.” Sidechains let you control an effect with one audio signal (the sidechain), while the effect processes a completely different audio signal. This is convenient for use with vocoders, compressors and limiters, gates, etc.

KRONOS includes two true- stereo FX Control Buses. For more information, see “FX Control Buses” on page 862 of the Parameter Guide.

**REC Bus**

This sends the external audio input signal to the REC buses (four mono channels; 1, 2, 3, 4).

The REC buses are dedicated internal buses used for sampling or for recording audio tracks in Sequencer mode.

If you want to sample these buses, set **Source Bus** to a REC bus.

In Sampling mode, you can mix several audio inputs to a REC bus for sampling, or you can mix the direct sound of audio inputs with the sound processed by insert effects and sample the combined result from the REC bus.

In other modes (e.g., Program mode), you can use the REC buses to sample just an audio input that’s playing along with a KARMA performance being output to the L/R bus.

**Off:** The external audio signal will not be sent to the REC buses. This is the default.

**1, 2, 3, 4:** The external audio input signal will be sent to the specified REC bus in mono. The **Pan** setting is ignored.

**1/2, 3/4:** The external audio input signal will be sent in stereo to the specified pair of REC buses. The **Pan** setting sends the signal in stereo to buses 1 and 2 or buses 3 and 4.

**Send1 (to MFX1), Send2 (to MFX2)**

These adjust the levels at which the external audio input signal is sent to the master effects.

**Send1 (to MFX1):** Send the signal to master effect 1.

**Send2 (to MFX2):** Send the signal to master effect 2.

If **Bus Select (IFX/Indiv.)** is set to IFX1–12, the send levels to the master effects are set by the post-IFX1–12 **Send1** and **Send2**.

**PLAY/MUTE**

This indicates whether the external audio signal being input is in PLAY or MUTE status.

You can control this using the front-panel MIX PLAY/MUTE 1–6 switches.

**SOLO On/Off**

This indicates the SOLO status of each external audio signal input. You can use the MIX SELECT 1–6 switches to change this.

Sound will be output only from channels for which SOLO is On. Other channels will be muted. The solo function includes the oscillators of the tone generator.

**Pan**

This specifies the panning of the external audio input signal. When inputting a stereo audio source, you will normally set the inputs to L000 and R127 respectively.

**Level**

Specifies the level of the external audio signal that will be input. Normally you will set this at 127.

*Note:* the meter to the left of the **Level** fader shows the signal level immediately after A/D conversion, *before* the **Level** control. Changing the **Level** will not affect the meter.

 The audio signals from the analog inputs are converted by an A/D converter from analog to digital signals. This parameter sets the level of the signal immediately after it has been converted into digital form. If the sound is distorted even though this level setting is very low, it is possible that the sound is distorting earlier than the A/D converter. You’ll need to adjust the MIC/LINE gain select switch, the LEVEL knob, or the output level of your external audio source.

 If **Bus Select (IFX/Indiv.)** isn’t Off, raising the **Level** will bring the external input signal into the KRONOS audio system. Any noise from the inputs (even if no actual signal is present) may be heard at the KRONOS outputs.

To prevent this, if you’re not using an input, turn its **Bus Select (IFX/Indiv.)** off, or set its **Level** to 0. **REC Bus** and **FX Control Bus** should also be turned off if you’re not using them.

The same is true for the **REC Source** parameter. If **REC Source** is set to an input, that input will be passed through directly to the outputs—even if the input’s **Bus Select** is Off, or its **Level** is 0.

Finally, for the same reason: if you’re not using the analog inputs, turn the rear-panel LEVEL knobs to the minimum, and set the MIC/LINE switches to LINE.

## Setting the recording level

The **Recording Level L** and **R** parameters adjust the signal level at the final stage of sampling. For the best-quality sampling, set the level as high as possible without allowing the level meter to indicate “CLIP !”

Press the SAMPLING REC switch to enter record-standby mode; the level meters will indicate the recording level of the signal from the bus line you selected in **Source Bus**. You can use the slider to adjust the signal level. Start with the slider at 0.00, and adjust the level as high as possible without allowing the bar indicator to exceed 0 dB.

The default setting is 0.0 dB.

## Specifying the recording method (Recording Setup)

### Source Bus

The Source Bus parameters controls what audio will be captured during sampling.

**L/R:** The L/R bus following TFX1 and 2 will be sampled. The audio signals sent to the L/R bus and sounds played on the KRONOS from the keyboard or via MIDI IN and sent to the L/R bus will be sampled. Normally you will use the L/R setting. (See the diagram below)

**REC1/2, REC3/4:** The REC1/2 or REC3/4 buses will be sampled. Use the REC buses when you want to play the keyboard or play back an audio CD while sampling only the audio input. You can also mix several audio input sources to the REC buses, or mix the direct sound of an audio input with sound processed by an insert effect and mix them to the REC buses for sampling.

If you choose REC1/2, REC bus 1 is input to the L channel and REC bus 2 is input to the R channel. If you choose REC3/4, REC bus 3 is input to the L channel and REC bus 4 is input to the R channel.

**Audio Input 1/2, S/P DIF L/R, USB 1/2:** Choose these settings if you want to directly sample from the analog, S/P DIF, or USB inputs. The input will be sampled directly without being routed through the L/R bus, REC buses, or Individual buses. The inputs will be connected directly, regardless of the **Audio Input** settings for **Bus Select (IFX/Indiv)**, **Pan**, and **Level**.

If you choose Audio Input 1/2, AUDIO INPUT 1 is input to the left channel and AUDIO INPUT 2 is input to the right channel.

**Indiv.1/2 and 3/4:** The Indiv.1/2–Indiv.3/4 buses will be sampled. Choose these settings if you want to sample only the audio inputs while monitoring the L/R outputs, similarly to when using the REC buses.

If you choose Indiv.1/2, Indiv. bus 1 is input to the L channel and Indiv. bus 2 is input to the R channel. Similarly for Indiv.3/4, the buses are input to the L and R channels respectively.

### Source Direct Solo

If this is unchecked, the L/R (post-TFX) signal and the signal of the bus line specified for **Source Bus** will be output from the L/R jacks and the headphone jack according to the Audio Input **Bus Select (IFX/Indiv.)** setting and the post-IFX **Bus Sel.** setting.

Normally you will leave this unchecked, so that **Source Bus** and “L/R” are both heard. Check this if you want to monitor only the sound that’s being recorded. Only the signal of the bus line selected for **Source Bus** will be output from the L/R jacks and the headphone jack.

*Note:* If **Source Bus** is L/R, this setting is ignored, and the L/R (post-TFX) signal will always be output from the L/R jacks and headphone jacks.

### Trigger

This controls how sampling will be initiated.

The triggers you can select will differ depending on the mode.

In Program and Combination modes, you can select either Sampling START SW or Note On.

In Sampling mode, you can select either of the above, plus Threshold.

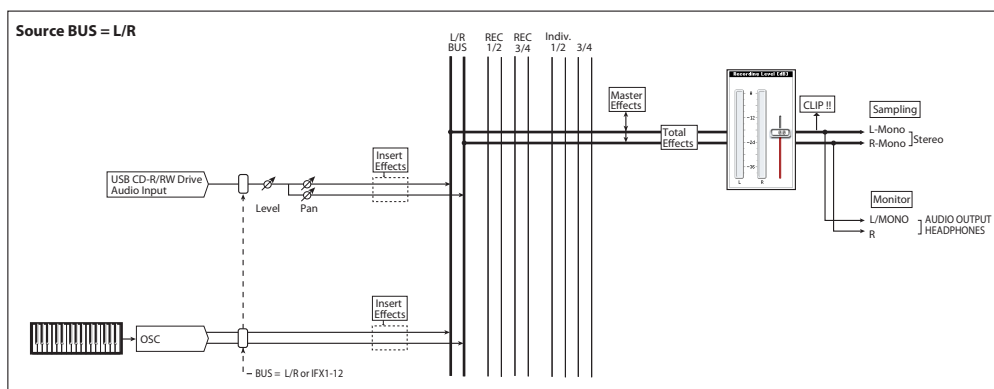

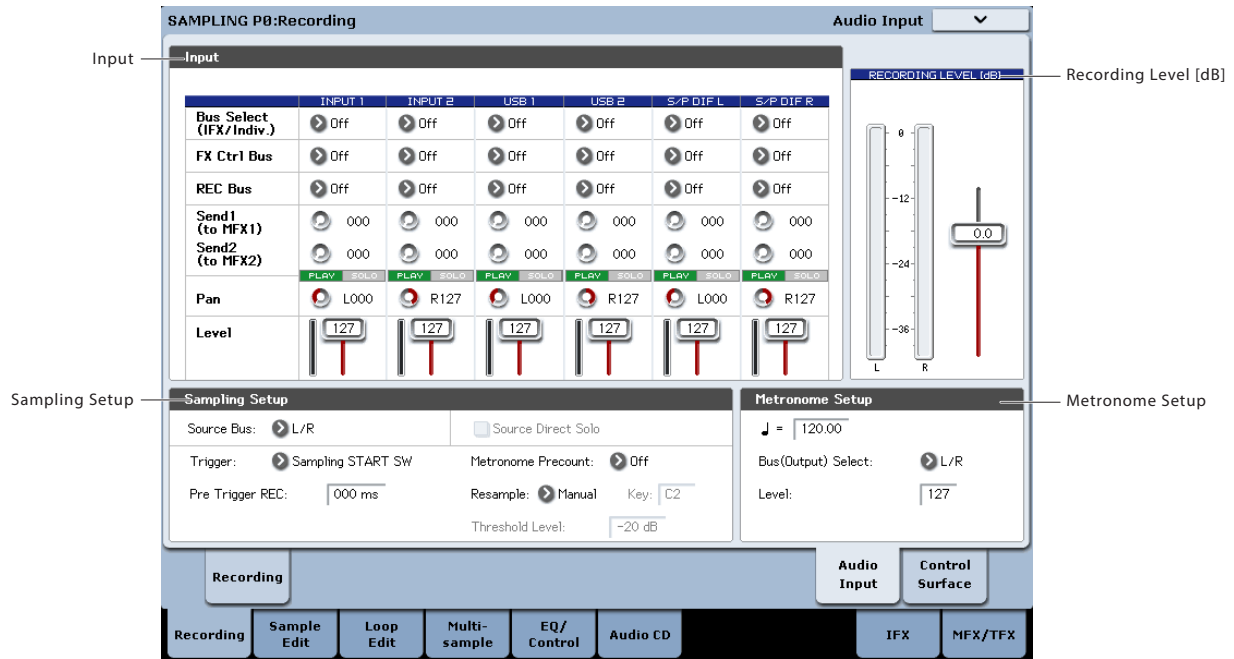

In Sequencer mode, you can select any of the above, plus the Sequencer START SW.

For the trigger mode that's most appropriate in various situations, refer to the various examples of sampling later in this chapter.

**Sampling START SW:** When you press the SAMPLING REC, you will enter sampling-standby mode; sampling will begin when you press the SAMPLING START/STOP switch.

**Note On:** Press the SAMPLING REC switch and then press the SAMPLING START/STOP switch to enter sampling-standby mode. Sampling will begin when you play the keyboard.

**Threshold:** Sampling will begin automatically when the input level exceeds the specified Level value.

**Sequencer START SW:** Press the SAMPLING REC switch and then the SAMPLING START/STOP switch to enter sampling-standby mode. Then press the SEQUENCER START/STOP switch to begin sampling. Use this when you want to resample the song playback.

To stop sampling, press the SAMPLING START/STOP switch once again. Sampling will also end if you keep sampling until the time specified by "Sample Time."

### Making settings for the sample to be recorded (REC Sample Setup/Sampling Setup)

Next we will specify the location into which the data will be sampled, select mono or stereo sampling, and specify the sampling time.

In Sampling mode, these settings are made in REC Sample Setup. In Combination, Program, and Sequencer modes, these settings are made in Sampling Setup. These settings apply only in each respective mode.

### The Recording Setup page in each mode

Mode	Page
Sampling	Sampling P0- Recording
Combination	Combination P0- Audio Input/Sampling
Program	Program P0- Audio Input/Sampling
Sequencer	Sequencer P0- Audio Input/Sampling

### Sampling mode

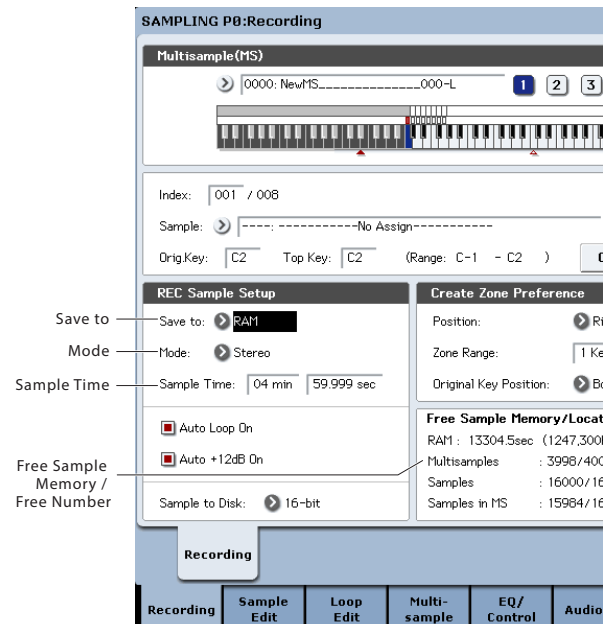



## Program mode

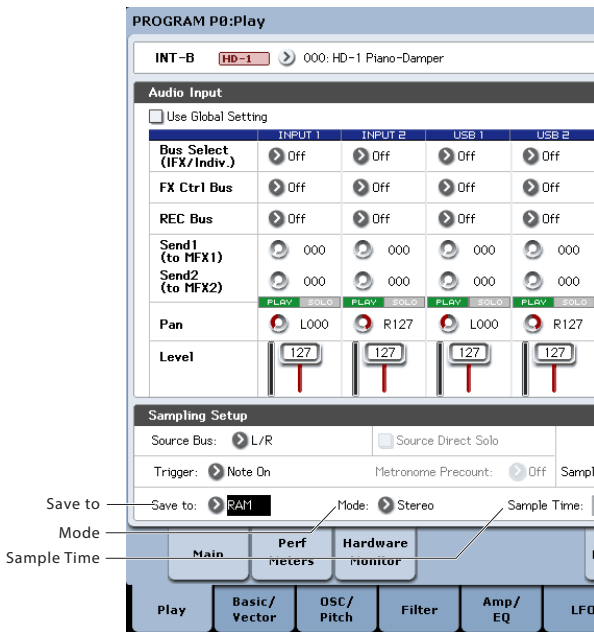

### Save to

Specifies the destination to which the data will be written during sampling.

**RAM:** The sample will be written to RAM memory. Samples written into RAM memory can be heard immediately in Sampling mode.

**Disk:** The sound will be recorded to disk as a WAVE file. You can select a disk, directory, and file name for the recorded file using the **Select Directory/File for Sample to Disk** menu command.

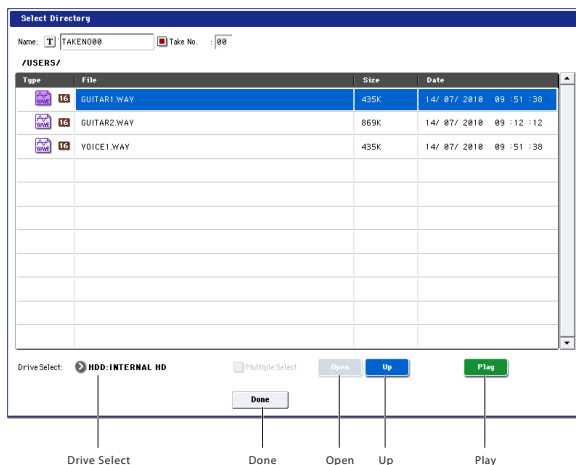

Use **Drive Select** to select the desired drive, which can be either an internal disk or a USB storage device. Then, use the **Open** or **Up** buttons to move to the desired folder level, and use the **Name** parameter at the top of the window to specify a name for the sample file. Press the **Done** button to confirm the settings you've made.

While this dialog is open, you can also audition the selected WAVE file by pressing the on-screen **Play** button or the front-panel **SAMPLING START/STOP** switch. To stop playback, either press the **SAMPLING START/STOP** switch again, or touch the on-screen Stop button.

### Mode

Specifies the channel(s) that you want to sample, and specify whether a mono or stereo sample will be created.

The L and R channels of the bus specified by **Source Bus** will be sampled.

**L-Mono:** The L channel of the bus specified by **Source Bus** will be sampled in mono.

**R-Mono:** The R channel of the bus specified by **Source Bus** will be sampled in mono.

**Stereo:** The L and R channels of the bus specified by **Source Bus** will be sampled in stereo. This will create a stereo multisample and samples.

### Sample Time

Specifies the amount of time that you wish to sample. This can be set in 0.001 second increments. If you record a sample in this condition ([REC]→[START]→[STOP]), the change in time will be displayed automatically.

If **Save to** is set to Disk, the maximum value is calculated from the amount of remaining space on the disk specified by **Select Directory/File for Sample to Disk**. The maximum sampling time is 80 minutes.

When sampling to disk, bit resolution may also affect the maximum sampling time. 24-bit data uses 50% more space than 16-bit data.

### Auto +12 dB On

In general, the **Recording Level** should be set to 0 (dB). For more information, see "Setting the recording level" on page 136.

In order to maintain headroom, the KRONOS generally plays back samples 12 dB softer than the original volume (if **+12 dB** is off). This is appropriate for sounds which will be played back polyphonically, such as samples of acoustic instruments.

For drum loops and similar material, on the other hand, you may wish to play back the data at the same level at which it was sampled. In this case, turn on the **+12 dB** parameter (Sampling P2– Loop Edit page).

If you sample with the **Auto +12 dB On** setting checked, **+12 dB** will automatically be turned on, and the recorded sample will play back at the same level at which it was sampled.

### Sample to Disk (Bit Depth)

When **Save To** is set to **Disk**, you can choose to record at either 16-bit or 24-bit resolution.

When **Save To** is set to **RAM**, the resolution is fixed at 16-bit.

### Optimizing RAM memory

Optimization rearranges any unused memory areas so that all of the remaining memory can be used, which may increase the amount of RAM available for sampling. This optimization can happen either manually or automatically.

Automatic optimization is enabled via the **Auto Optimize RAM** parameter on the Global mode P0: Basic Setup page. When this is turned on, RAM will automatically be optimized when sampling ends.



This option will keep the greatest amount of RAM free for sampling. However, it requires a little time to work, and so the sound will stop for a time after sampling ends. Also, if a song is playing in Sequencer mode, the playback will stop.

Because of this, if you're playing back a song or recording multiple samples at once, it's probably better to leave **Auto Optimize RAM** turned off. Once you're finished sampling, or if you notice that the amount of available RAM is getting low, use the **Optimize RAM** menu command to do the optimization manually. You can find this command on the menus of the Sampling pages in Program, Combination, and Sequencer modes, as well as on pages P0-4 in Sampling mode.

You can check on the remaining amount of memory in Sampling mode on the P0: Recording page, under Free Sample Memory/Locations. For more information, see "0-1f: Free Sample Memory/Locations" on page 686 of the Parameter Guide.

### Using the metronome

The metronome can be helpful when you want to play a Program or Combination at a specific tempo and sample your performance.

You can make metronome settings in **Metronome Setup**, in Program or Combination P0: Play- Audio Input/Sampling. You might find it convenient to set **Bus (OUTPUT) Select** to one of the Indiv. 1-4 outputs, connect the (INDIVIDUAL) 1-4 jacks to a mixer, and monitor the metronome via your mixer.

### Automatically setting-up for the desired sampling method (Auto Sampling Setup)

In each mode, Auto Sampling Setup automatically makes the appropriate settings for the sampling-related parameters. For example in Program mode you can use this to make the necessary settings for resampling your playing on a program, or to make settings for sampling only an external audio source while you monitor your playing on a program. However, these automatic settings assume typical situations, so you'll need to adjust the parameters to meet your situation.

This function is available in the following pages:

Mode	Page
Sampling	Sampling P0: Recording
Combination	Combination P0: Play- Audio Input/Sampling
Program	Program P0: Play- Audio Input/Sampling
Sequencer	Sequencer P0: Play/REC- Preference, Audio Input/Sampling

## Sampling and editing in Sampling mode

In Sampling mode, you can record samples, and edit sample data that you sampled or loaded from media (including WAVE and AIFF formats). You can also assign the edited samples to indexes (zones) to create a multisample.

### *Sampling mode page structure*

<b>Page</b>	<b>Explanation</b>
P0: Recording	<ul style="list-style-type: none"><li>• Sampling and resampling</li><li>• Various settings for sampling</li><li>• Audio input settings</li><li>• Edit using the control surface</li></ul>
P1: Sample Edit	<ul style="list-style-type: none"><li>• Sample waveform editing</li></ul>
P2: Loop Edit	<ul style="list-style-type: none"><li>• Sample playback parameter settings</li><li>• Start, loop start, and end address settings</li><li>• Loop and reverse playback on/off</li><li>• Editing operations such as Time Slice and Time Stretch</li></ul>
P3: Multisample Edit	<ul style="list-style-type: none"><li>• Assign samples to multisamples, and specify the zone and original key</li></ul>
P4: EQ/ Controller	<ul style="list-style-type: none"><li>• EQ adjustments for multisample playback</li><li>• Assign functions to controllers</li></ul>
P5: Audio CD	<ul style="list-style-type: none"><li>• Play back audio CDs</li><li>• Rip audio CDs</li></ul>
P6:	---
P7:	---
P8: Insert Effect	<ul style="list-style-type: none"><li>• Select and edit insert effects, adjust send levels to the master effects, and specify the routing to the outputs</li></ul>
P9: Master, Total Effects	<ul style="list-style-type: none"><li>• Select and edit master send effects and total effects</li></ul>

For details on how to access each mode and page, refer to “Basic operations” on page 17.

Sampling can be performed in any page P0–P9 of Sampling mode by using the REC/WRITE switch and the START/STOP switch. Recording-related settings such as input level are made by the parameters of P0: Recording, and these settings are valid for the other pages as well.

The selected multisample or sample can be played from the keyboard in any page, allowing you to hear the results of your editing in each page.

## Creating multisample indexes and sampling-P0: Recording

Here's how to create indexes in a multisample, and assign a sample to each index.

1. Press the **SAMPLING** button to enter **Sampling mode**.
2. Select the **P0: Recording- Recording** page.
3. Select "**Multisample Select,**" and create a multisample.

To create a new multisample, press the **Multisample Select** popup button. Then press a Multisample No. in the list for which no name has been entered, or use the numeric keys 0-9 to input a number and then press the **ENTER** switch.

A dialog box will appear.



If you want to create a stereo multisample, check the **Stereo** box, and press the **OK** button.

If you want to create a monaural multisample, uncheck the **Stereo** box, and press the **OK** button.

4. Press the **Create** button to create an index.

Immediately after the power is turned on, **Index** will show 001/008. This indicates that there are eight indexes, and that the first index is selected (see the illustration below).

Press the **Create** button several times. Each time you press it, an index will be created. The keyboard display will indicate the zone and original key location of each index.

*Note:* The index that is created when you press the **Create** button will be created according to the **P0: Recording-Recording** page **Create Zone Preference** settings. (These settings can also be made in **P3: Multisample Edit** page, **Create Zone Preference**)

Immediately after the power is turned on, **Position** will be **Right** (to selected index), **Zone Range** will be **1 Key**, and **Original Key Position** will be **Bottom**, so that indexes will be created as shown below. This is convenient when you want to sample multiple takes of a phrase or rhythm loop in a single operation.

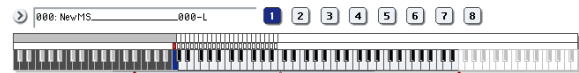

If you set **Zone Range** to **12 Keys**, indexes will be created at intervals of one octave.

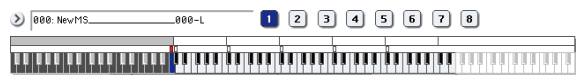

5. Select "**Index.**"

You can also select **Index** by holding down the **ENTER** switch and playing a pad or a note on the keyboard. For this example, select 001.

6. Assign a sample to the "**Index.**"

If RAM memory already contains samples, use **Sample Select** to select the sample and assign it.

If you want to record a new sample, you can sample it now.

The sample you record will be automatically assigned to the index you selected in step 4.

The assigned sample will sound when you play the keyboard in the range of the index to which the sample is assigned.

7. Repeat steps 5 and 6 to assign a sample to each index.

The number and order of the indexes in a multisample, the range of each index, and the original key position can be freely changed later if desired. (See "**Multisample editing**" on p.153)

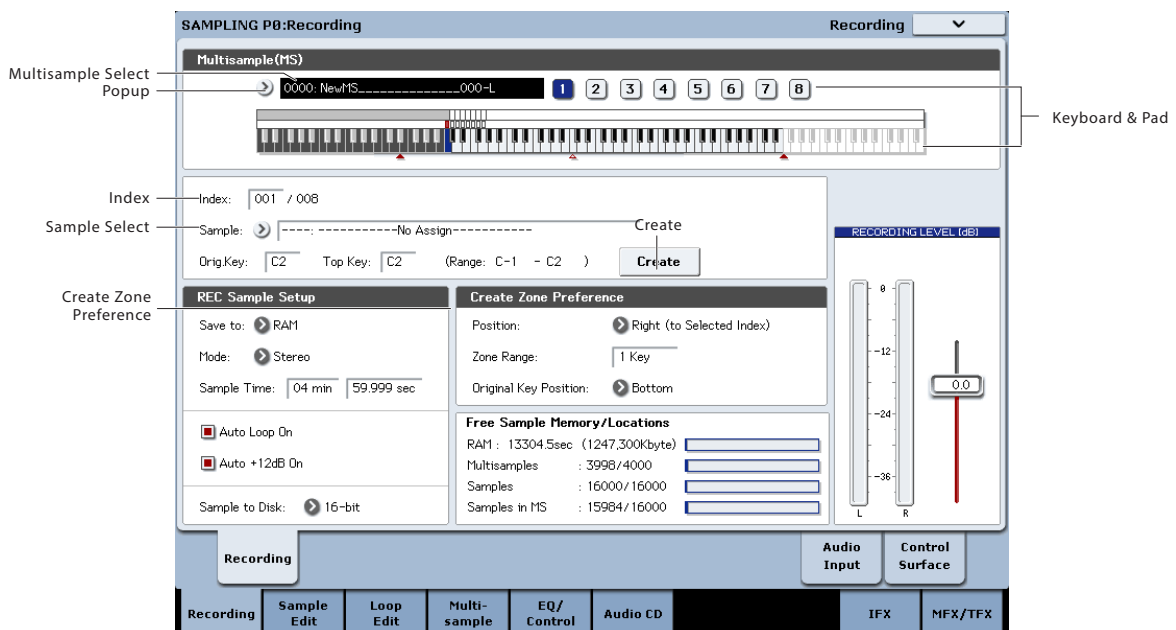

### Creating multiple samples

In the example procedure described above, several indexes were created (by pressing the Create button several times), and then samples were assigned to each Index.

As an alternative method, it is also possible to create one index, sample into it, and then repeat these two steps.

1. Press the Create button once to create an index.
2. Record a sample.

The recorded sample will automatically be assigned to the index you created in step 1.

3. Repeat steps 1 and 2.

This is an efficient way to record multiple samples.

### Assigning samples to the pads

In Sampling mode, you can use the pads to play samples directly. The on-screen pads are available on the P4:EQ/Controls page. USB controllers, MIDI input, and the local keyboard can all control the pads as well; for more details, see “Playing the pads” on page 39.

By default, pads 1–8 correspond to the C2–G2 keys. For example, the default **Index** setting for 001/008 sets **OrigKey** and **Top Key** to C2. The assigned sample will sound when you play the C2 key. The same sample will also sound when you play pad 1.

Similarly, if you assign samples to **Index** 002–008, the samples that sound when you play the C#2–G2 keys will also sound when you play pads 2–8.

For each pad, you can change the note numbers used to play samples.

For example, you might assign the infrequently-played highest eight notes of the keyboard to correspond to the pads. To make the setting, select the note number field, and play the desired key while holding down the ENTER switch.

#### Assigning samples to the pads

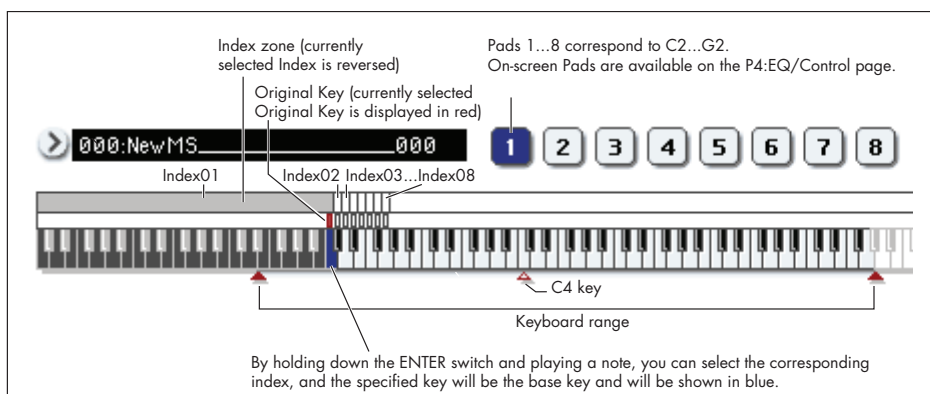

#### On-screen pads in Sampling mode

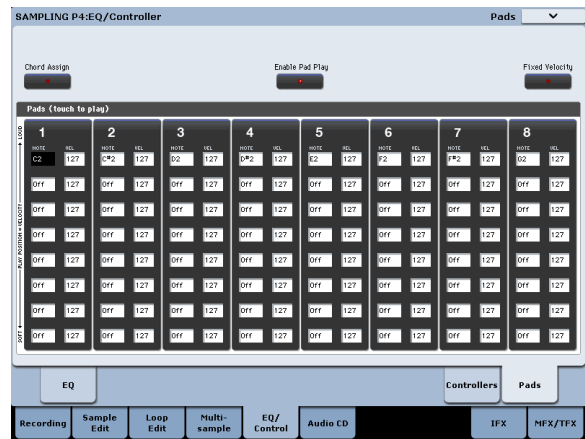

## Basic examples of sampling

### Sampling your voice from a mic, and playing it back as a one-shot sample

In this example, we'll use a mic connected to AUDIO INPUT 1 to sample your voice.

#### Connect a mic

1. Connect a mic to the rear panel AUDIO INPUT 1 jack.
2. Press the AUDIO INPUT MIC/LINE switch so that it's in the MIC (outward) position, and set the LEVEL knob near the center.

For more details, see "Audio input settings" on page 134.

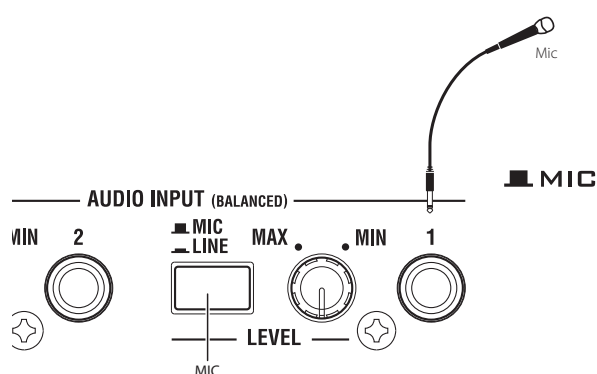

#### Sampling Setup

1. Go to the Sampling P0: Recording– Audio Input page.

Press the SAMPLING button to enter Sampling mode. Make sure that the Sampling P0: Recording page is displayed.

If it is not, press the EXIT switch, and then press the Audio Input tab.

2. Choose the menu command "Auto Sampling Setup."

A dialog box will appear. Auto Sampling Setup automatically sets many of the parameters necessary for sampling. You can use these settings as a guideline when sampling.

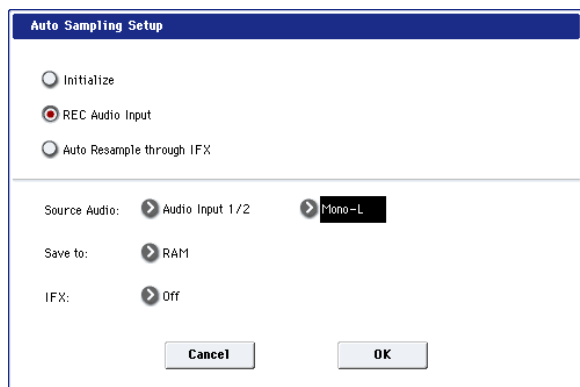

3. Select "REC Audio Input."

This will make settings for sampling an external audio source.

4. Set "Source Audio" to Audio Input 1/2.

This means that you'll be sampling the instrument or other external audio input source connected to AUDIO INPUT 1 and 2.

5. To the right of Source Audio, select Mono-L.

With this setting, the input from the INPUT 1 jack will be sent to the internal L-channel and sampled monaurally.

6. For the "Save to" field, select RAM.

The sampled data will be written into RAM memory.

7. Turn "IFX" Off.

You will be sampling without applying an insert effect.

8. Press the OK button to execute the command.

You have now made the settings necessary for sampling.

Note: Take a look at the settings that have been made.

**Audio Input:** Inputs 1 and 2 have been routed to the L/R bus, with their Pan set hard left and hard right respectively, and input levels set to 127.

**Source BUS:** L/R

The sound(s) sent to the L/R bus will be sampled. With the settings above, this includes Inputs 1 and 2.

**Trigger:** Sampling START SW

Sampling will start when you press the SAMPLING START/STOP switch.

**Recording Level:** 0.0

This is the default setting for recording an external input.

**Save to:** RAM

You will be sampling to RAM memory.

9. Press the Recording tab to go to the P0: Recording– Recording page.

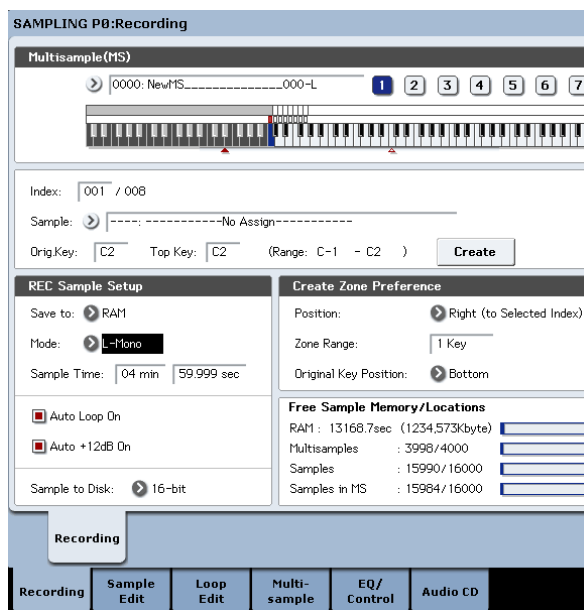

Under REC Sample Setup, note that Sampling Mode has been set to L-Mono. This means that the sound of the internal L channel will be sampled in mono.

Next, let's change the **Trigger** setting. This controls how sampling will start. Currently, it's set to start when you press the Sampling START/STOP button. We'll change it to make sampling start when the audio input exceeds a specified volume.

### 10. Go back to the Sampling P0: Recording– Audio Input page.

### 11. Make the following settings.

#### Trigger: Threshold

With this setting, sampling will start when the input exceeds a specific volume.

#### Threshold Level: –30 dB

From the record-ready state, recording will start automatically when the audio input exceeds –30 dB.

#### Pre Trigger REC: 005ms

Recording will begin immediately (5 ms) before sampling is started, so that the attack of the sound is not lost.

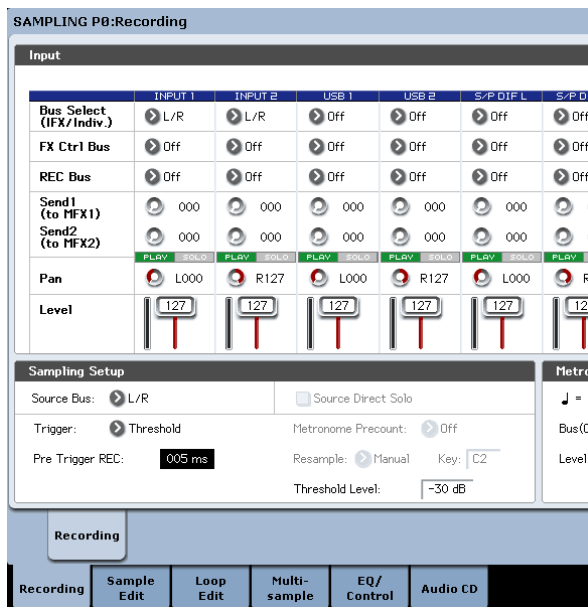

### Set the recording level

### 12. Speak or sing at the volume you intend to record.

If the “ADC OVERLOAD !” (AD converter input overload) indication appears, turn the rear panel LEVEL knob toward MIN to adjust the level appropriately.

For the best sound, adjust the level as high as possible without allowing the “ADC OVERLOAD !” indication to appear.

### 13. Press the SAMPLING REC switch.

Speak into the mic, and notice that the level meter indicates the volume of the sound that will be recorded.

If the “CLIP!” indication appears, use the VALUE controller to lower the **Recording Level** slider (shown in the right of the display) from the 0.0 setting to an appropriate position.

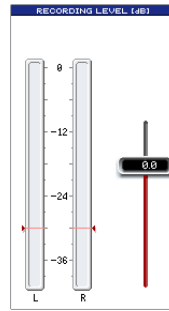

### 14. When you've finished making adjustments, press the SAMPLING REC switch.

### Record

### 15. Press the SAMPLING REC switch.

The KRONOS will be in record-ready mode.

### 16. Speak into the mic, saying the word(s) you want to sample.

(Example: “It’s”)

Recording will start when the level exceeds the Level –30 dB setting.

### 17. When you've finished saying the word(s), press the SAMPLING START/STOP switch.

This completes the sampling operation. The new sample will be automatically assigned to “Sample (Sample Select).”

### Hear the sampled result

### 18. The sample you just recorded will (by default) be assigned to Index 001. When you press the “OrigKey” key (C2) for Index 001, you will hear the sound you just sampled.

Notice that the sample will loop (play repeatedly) if you hold down the key. We're going to turn looping off.

### Turn looping off

### 19. Press the Loop Edit tab to go to the P2: Loop Edit page.

Uncheck **Loop**. Now the sample will not loop even if you hold down the C2 key.

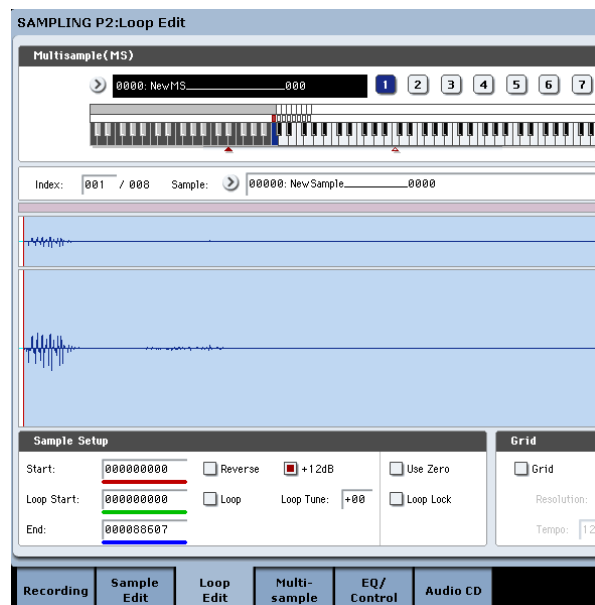

Next, we'll specify that looping will be turned off for each newly recorded sample.

**20. Press the lower Recording tab and then the upper Recording tab to go to the P0: Recording– Recording page.**

**21. Uncheck Auto Loop On.**

If Auto Loop On is checked, the Loop setting will automatically be turned on when you sample, so that the sample will loop.

**Record the next sample**

**22. In the P0: Recording, Recording page, select “Index” and press the  $\wedge$  switch to select 002.**

**23. Press the SAMPLING REC switch and then the SAMPLING START/STOP switch.**

Speak into the mic, saying the word(s) you want to sample.

(Example: “So”)

When you've finished speaking, press the SAMPLING START/STOP switch.

**24. Repeat steps 14 and 15 several times more to record a few more samples.**

(Example: “Easy,” “To,” “Sample,” “With,” “KRONOS”)

**Listen to the recorded result**

**25. Play the keys one after another.**

Play the keys starting at C2 in semitone steps. The samples you just recorded will play one after another.

(For example if you sequentially play the keys from C2 through F#2, you will hear “It's So Easy To Sample With KRONOS.”)

The multisample you created can be used as a program or combination. (See “Converting a Multisample to a Program” on page 154)

## Sampling external audio through insert effects

In this example, we'll apply an insert effect to the sound from a mic connected to the AUDIO INPUT 1 jack, and sample the processed sound in stereo.

**Connect a mic**

**1. Connect your mic to the rear panel AUDIO INPUT 1 jack. (See “Sampling your voice from a mic, and playing it back as a one-shot sample” on page 143)**

**Setup**

**2. In the P0: Recording– Audio Input page, make the following settings.**

– INPUT1 –

**Bus Select (IFX/Indiv.):** IFX1

**Pan:** C064

**Level:** 127

This specifies the input level and pan of the INPUT 1 jack, and assigns IFX1 bus as the destination.

– Sampling Setup –

**Source Bus:** L/R

**Trigger:** Threshold

**Threshold Level:** –30 dB

**Pre Trigger REC:** 005ms

For details on Recording Setup, refer to step 3 of “Sampling your voice from a mic, ...”

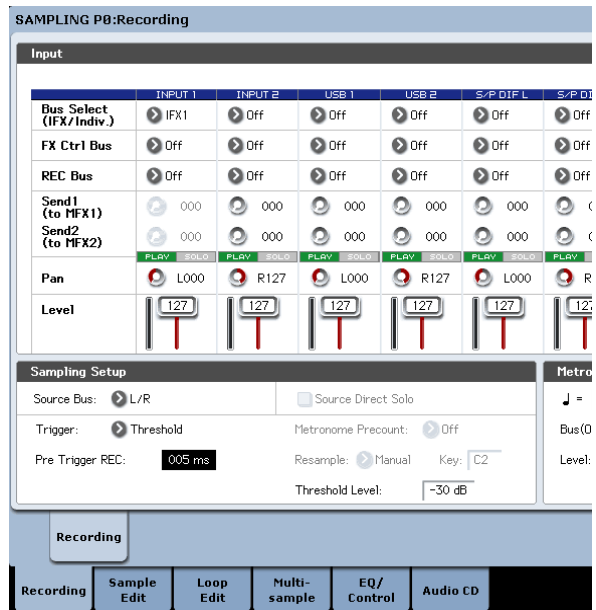

**3. Go to the P8: Insert Effect– Insert FX page.**

Press the IFX tab, and then the Insert FX tab.

**4. Select IFX1, use the numeric keys to input 1, 0, 1, and press the ENTER switch to select 101: Reverb Hall.**

Press IFX1 On/Off to turn it on.

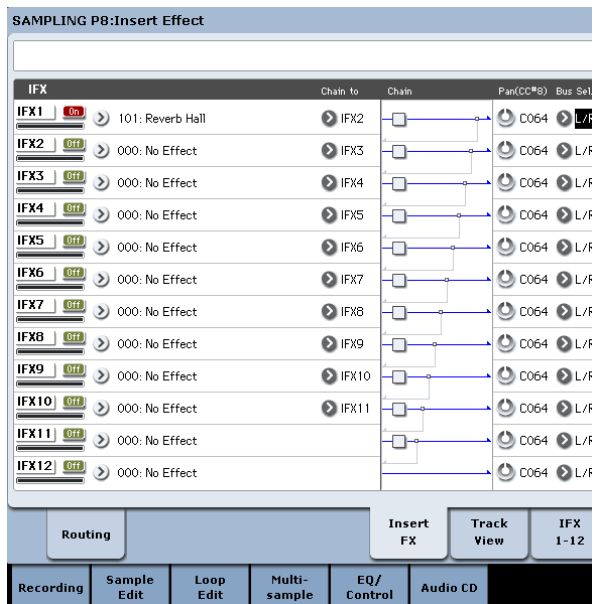

**5. Speak into the mic, and verify that reverb is applied.**

You can use the IFX1 page (IFX1 tab) to edit the effect settings.

**6. Make sure that the Bus Sel. that follows IFX1 is set to L/R.**

**7. Press the EXIT switch, and then press the Recording tab to go to the P0: Recording– Recording page.**

**8. Set the REC Sample Setup Mode to Stereo.**

With this setting, the sound of the internal L/R channels can be sampled in stereo.



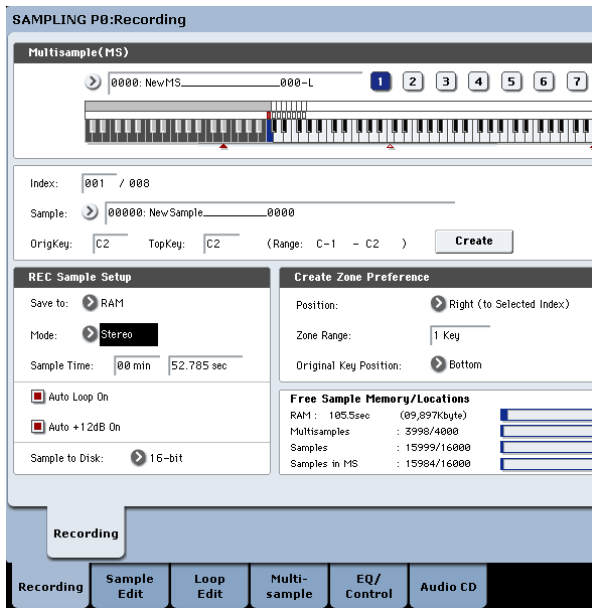

**9. Select Index.**

If you want to create a new index, press the Create button.

**10. Sample the sound.**

Press the SAMPLING REC switch, and then the SAMPLING START/STOP switch to enter record-ready mode.

Speak the word you want to sample.

Recording will start when the level exceeds the Level -30 dB setting.

Press the SAMPLING START/STOP switch to stop sampling.

**11. Play the keyboard.**

Press the “OrigKey” key to hear the sound you sampled.

**Sampling from the S/P DIF input**

In general, sampling from the S/P DIF inputs is very similar to sampling from the analog inputs. For instance, to record a stereo sample from the S/P DIF inputs, set up the sampling parameters as below:

**Source Bus:** S/P DIF L/R

**Resample:** Manual

**Recording Level [dB]:** as desired

**Mode:** Stereo

Important: Whenever using the digital inputs and outputs, make sure that the Global **System Clock** parameter is set correctly. For more information, see “System Clock” on page 756 of the Parameter Guide.

**Applying an insert effect to a sample and resampling the result**

You can process a sample through effects, and then sample the result. This is called “resampling.” During resampling, the KRONOS can even play a selected source sample automatically.

To do this:

1. Go to the P0: Recording–Audio Input page.
2. In the Sampling Setup section, set the Key to the desired source sample.

This selects the sample to be played and resampled. When the power is first turned on, Key will be set to C2.

3. In the Input section, set Bus Select (IFX/Indiv.) to Off for all six inputs.

This ensures that no extraneous input sounds will be recorded, and prevents feedback.

⚠ If the Bus setting is anything other than Off, the steps below may cause loud feedback in the main L/R outputs and headphones.

4. In the Sampling Setup section, set the Source Bus to L/R.

This means that the sampling will capture all sounds sent to the main L/R output.

5. Set Trigger to Sampling START SW.

After you’ve pressed the SAMPLING REC switch to enter sampling-ready mode, resampling will begin when you press the SAMPLING START/STOP switch.

6. Set Resample to Auto, and then set Key to C2.

When you press the Sampling START button, the selected Key will be played automatically.

7. Using the on-screen slider, set the Recording Level to 0.0.

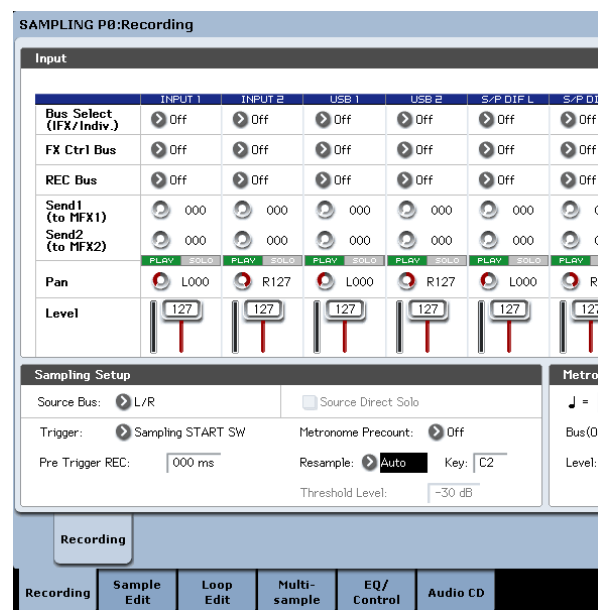

8. Go to the P0: Recording–Recording page.

9. Set “Save to” to RAM.

The data will be recorded into RAM for use in Sampling Mode.

10. Set the Mode to Stereo.

11. Enable Auto +12dB On.

The +12 dB setting will be turned on for the newly recorded samples.

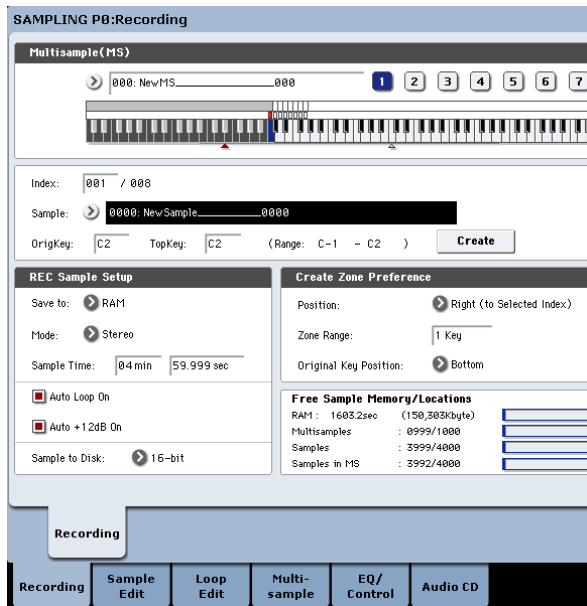

12. On the P8: Insert Effect—Routing page, under Bus Select, set “All OSCs to” to IFX1.

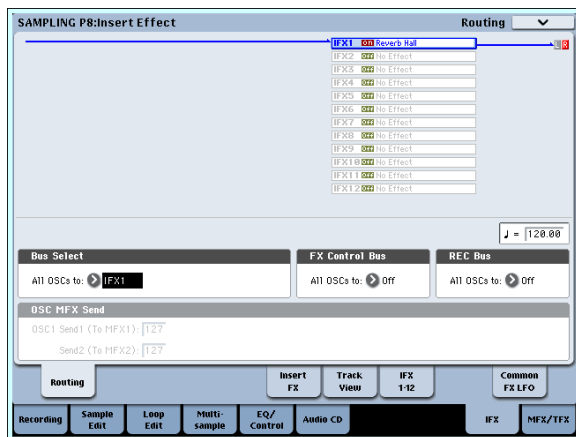

13. On the P8: Insert Effect—Insert FX page, set IFX1 to 101: Reverb Hall, and turn on IFX 1.

Also make sure that IFX1’s Bus Sel. is set to L/R.

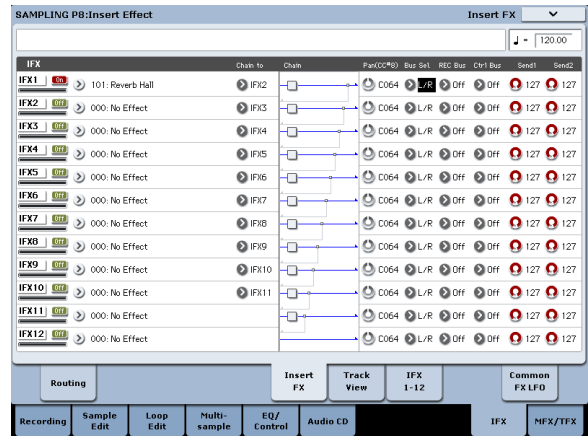

Press the C2 key, and verify that reverb is applied.

14. Press the SAMPLING REC switch, and then the SAMPLING START/STOP switch.

The sample assigned to C2 will play automatically, and resampling will begin.

When the sample finishes playing, resampling will end. The sample that was created by resampling will automatically be assigned to Sample Select.

*Note:* In Sampling mode, the P8—Routing page Bus Select parameter will automatically be set to L/R when resampling ends. This prevents an insert effect from being applied in duplicate when you monitor the results of resampling through an insert effect.

If you want to apply an insert effect once again, re-select IFX1.

*Note:* As an alternative to automatically resampling as described above (Resample Auto), you can simply sample the sounds that you play from the keyboard (Resample Manual).

In Sample Select, assign the sample that you will resample, and set Resample to Manual. Set Trigger to Note On, and set the Mode to Stereo. Then set the bus and effect as described in steps 2 and 7, press the SAMPLING REC and then the START/STOP switch, and finally press the C2 key to start resampling. When you want to stop resampling, press the SAMPLING START/STOP switch.

## Editing loops

You can edit the playback address at which the sample will be looped. The P2: Loop Edit page lets you do the following things.

- You can specify the looping addresses by editing **Start**, **End**, and **Loop Start** while watching the waveform. Functions like Zoom In/Out, Use Zero, and Grid make editing easy.
- You can turn looping on/off, adjust the tuning of the loop playback, apply a +12 dB playback boost, or reverse the playback.
- You can use the Time Slice function to automatically detect the attacks of kick and snare notes etc. in a rhythm loop sample (a looped sample containing a drum pattern), and automatically slice the sample at the appropriate locations. This function can automatically

create performance data (notes) to play the divided samples at the appropriate moments, letting you play this phrase in Sequencer mode at the desired tempo without affecting the pitch of the individual notes. You can also do things like changing the pitch of just the snare drum, replacing it with an entirely different sample, or changing the playback timing of the phrase in the sequencer to transform the original rhythm loop into an entirely different rhythm loop. (Stereo samples are supported.)

- You can use the Time Stretch function to modify the tempo without changing the sample’s pitch. When executing Time Stretch, you can choose either “Sustaining” (suitable for loops of sustained sounds such as strings or vocal) or “Slice” (suitable for loops of

decay-type sounds such as drums). (Stereo samples are supported.)

- Sometimes when looping a sample of pitched instruments such as strings or winds, the looped portion may play back in an unnatural way. By executing the Crossfade Loop function you can eliminate this problem so that the loop sounds right.

### Loop settings

1. Select the sample for which you wish to make loop settings.

To select the sample, use the **Sample Select** or **Index** parameters of P2: Loop Edit page or of the P0: Recording, Recording page.

- ⚠ If you use **Sample Select** to select the sample, be aware that the assignment to the index will also change.

2. In the P2: Loop Edit page, use the “Loop” check box to turn loop playback on/off for the sample.

Looping will be turned on if the box is checked.

This will operate between the addresses you specify in step 3.

Loop On: Start→End→Loop Start→End→ (Loop Start→End is repeated)

Loop Off: Start→End

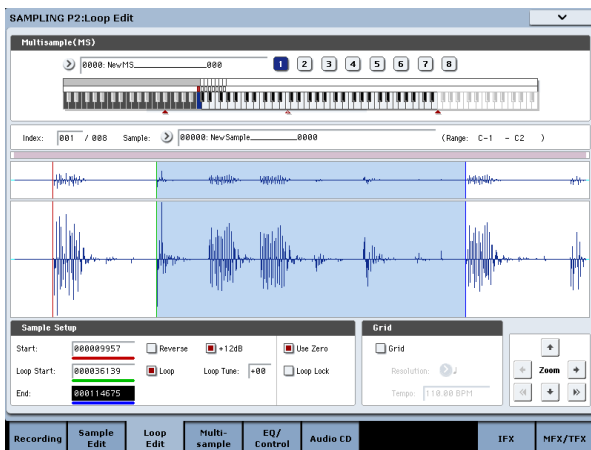

To play the sample, press the key to which the sample is assigned (the key range that is highlighted in **Keyboard & Pad**).

A sample waveform that was sampled with **Sample Mode** set to Stereo will be displayed in two levels. The upper level is the L channel, and the lower level is the R channel.

3. Set the start address in “Start,” the loop start address in “Loop Start,” and the end address in “End.”

Select **Loop Start** (highlighted), and use the [VALUE] dial or other VALUE controllers to modify the value. The corresponding vertical line will move. Set **Start** and **End** in the same way. In the example shown below, **Start** is set immediately before the first waveform, **Loop Start** is set immediately before the second waveform, and **End** is set as desired.

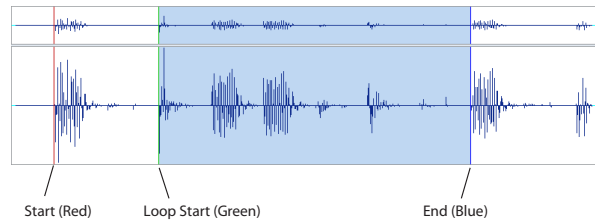

### ZOOM

4. By using the ZOOM button you can change the range that is displayed. When “Start” is highlighted, zoom will be performed from the start address.

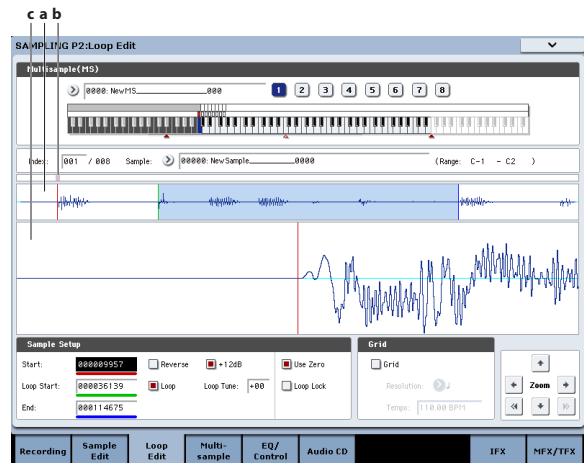

Area “a” shown in the illustration displays the entire sample. Area “b” indicates the region within the entire sample that is shown in area “c.” As you zoom-in on the time axis, this shows you where the zoomed region is located within the entire sample. Use the Zoom buttons to specify how area “c” will show a magnified (zoom-in) or reduced (zoom-out) view of the waveform.

### Use Zero

If the **Use Zero** check box is checked, only those addresses where the waveform data crosses the zero level will be found automatically when searching, and can be set. This lets you easily make address settings where noise is less likely to occur when looping.

### Truncate

5. If necessary, use the page menu command “Truncate” to delete unwanted data that falls outside the start (or loop start) and end addresses.

Select the **Front & End** radio button.

In this example, we will not change the settings of the **Save to No.** and **Overwrite** check boxes, so press the OK button to execute.

When you execute this operation, the truncated sample data will automatically be assigned to the index.

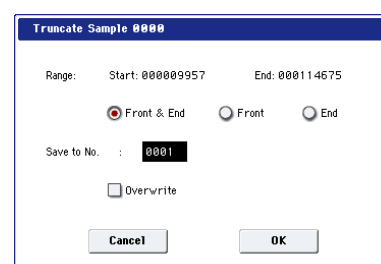

 In the dialog boxes of some page menu items, there is a **Save to No.** setting that lets you specify the sample number to which the edited sample will be saved. At this time, a vacant sample number will be selected automatically, so you will change the setting only if you want to specify the save destination number.

If you check **Overwrite** in the dialog box of the command, the data prior to editing will be deleted and overwritten by the edited data. Normally, you will execute the Write operation without checking this, so that the unedited data is preserved. When you are completely finished with your editing, you can use the page menu command **Delete Sample** to delete unneeded samples.

## Using the grid to make loop settings

**Grid** overlays a grid on the waveform display to indicate the tempo BPM. This helps you make loop settings that match the tempo.

You can also view the grid in the P1: Sample Edit page, and use the grid to edit the waveform to match the tempo.

## Using Time Slice

Time Slice is a function that detects the attack of the kick or snare etc. in a rhythm loop sample (a sample consisting of a looped pattern of drums etc.), and automatically divides it into separate instrumental sounds. Each of the divided instrumental sounds is made into a sample of its own, and then automatically expanded into a multisample and program. Pattern playback data for the Sequencer mode using the divided samples is also created automatically.

The time-slices sample can be used in the following ways by the song of Sequencer mode.

- Multiple rhythm loop samples of differing tempo can be matched to the same tempo without changing their pitch.
- You can change the tempo in realtime without affecting the pitch.

As an example, we will describe how a rhythm loop sample can be time-sliced in Sampling mode, and then how the rhythm loop sample can be played in Sequencer mode.

You will need to provide rhythm loop samples of drums etc. You can either record these on the KRONOS, or load them in Disk mode. Initially, you should try this using a one-measure pattern in 4/4 time with a fairly simple beat, and record the pattern as a mono rhythm loop sample.

### 1. Use “Sample Select” to select the sample data that you want to time-slice.

Play back the sample, and verify that the beats that you want to loop are played cleanly.

If they are not played cleanly, make the appropriate settings for the start address **Start** and end address **End**, and execute the page menu command **Truncate** (See “Loop settings” on page 148).

### 1. Check “Grid.”

The grid will appear in the waveform display.

Set **Resolution** as desired, and specify the tempo BPM value.

The grid is displayed according to the playback pitch at the base key (the key shown in blue for “Keyboard & Pad”). You can select the base key by holding down the ENTER switch and playing a key.

Press the base key to play the sample, and press the TAP TEMPO switch at quarter-note intervals along with the phrase. This will enable Tap Tempo and specify the tempo.

### 2. Set the end address “End” so that it coincides with a grid line.

This will make the loop length match the BPM.

If looping is on, the grid is displayed beginning at the **Loop Start**. If looping is off, the grid is displayed beginning at the **Start**.

### 3. If you want to hide the grid display, uncheck the “Grid” option.



- Go to the **P2: Loop Edit** page. Select the page menu command “**Time Slice**.”

The Set Sample Tempo dialog box will appear.

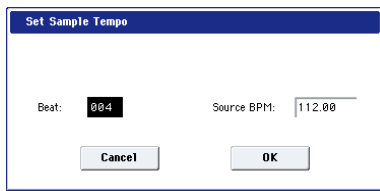

- Specify the number of quarter-note beats in the sample, and its tempo.

If you know the tempo in BPM, set the **Source BPM** accordingly.

If you do not know the BPM, use **Beat** to enter the total number of beats, and the BPM will be calculated automatically.

- Press the **OK** button.

The sample will automatically be sliced, and a dialog box will appear.

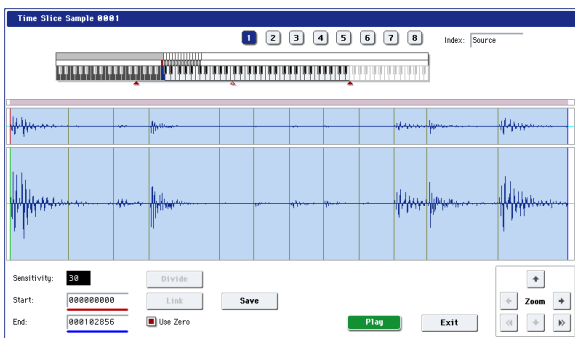

When you play the keyboard, C2 will play the original sample (Source), and D2 and subsequent keys will play the divided samples.

While listening to each divided sample, adjust **Sensitivity** so that each drum strike or other rhythm instrument sound is divided into its own sample. In some cases, it may not be possible to slice the sample cleanly even if you adjust **Sensitivity**. If the attack of the next sound is included in the end of the preceding sample, or if one sample contains two notes, you will need to edit the samples.

If you want to edit, hold down the ENTER switch and select the **Index** that is assigned to the note that you want to edit. (This portion of the waveform display will be highlighted.) Then you can make adjustments by adjusting **Start** or **End**, and by using Divide to separate or Link to combine.

For more information, see “Time Slice” on page 742 of the Parameter Guide.

- Press the **Save** button.

The Save Samples & MS dialog box will appear.

Here you can save the time-sliced samples and the multisample.

At this time, set the items in the Save With area to specify the conversion destination for the program that will use the samples and multisample, and for the performance data (track or pattern) that will be used in Sequencer mode to “recreate” the rhythm loop sample.

- If you want to create the performance data in a track: Turn **Program** and **Seq.Event** On (checked)

Program: as desired (for instance, U-G000)

Track: On

Song: 000, Track: 01, Meter: 4/4

Start Measure: 001, Time: 008

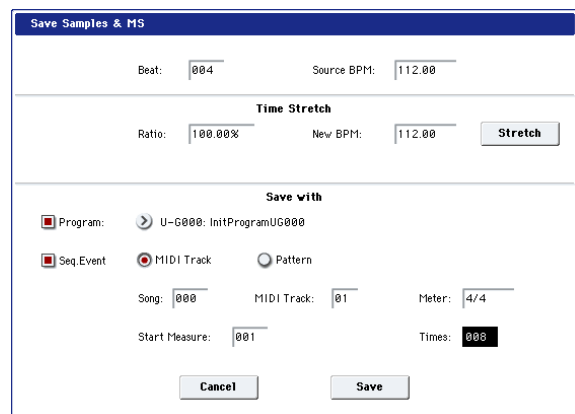

Press the Save button to save the data.

You will return to the dialog box of step 4.

- If you want to create the performance data in a pattern: In order to audition the performance data as it would be if created as a pattern, press the Save button once again to go to the Save Samples & MS dialog box.

Turn **Program** and **Seq.Event** On (checked)

Program: as desired (for instance, U-G001)

Pattern: On

Song: 001, Pattern: U00, Meter: 4/4

RPPR: On (checked), Key: C#2, Track: 01

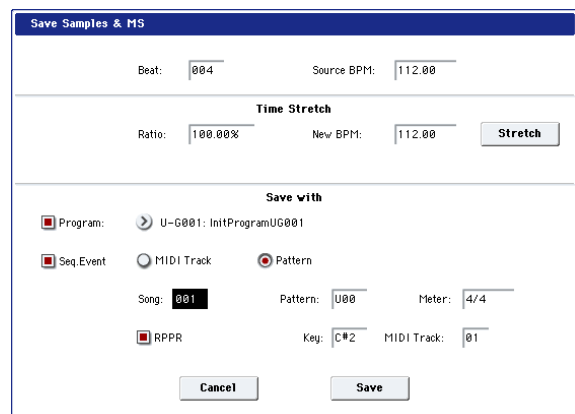

Press the Save button to save the data.

You will return to the dialog box of step 4.

- Press the **Exit** button.

**7. Press the SEQ button to enter Sequencer mode, and select 000 for “Song Select.”**

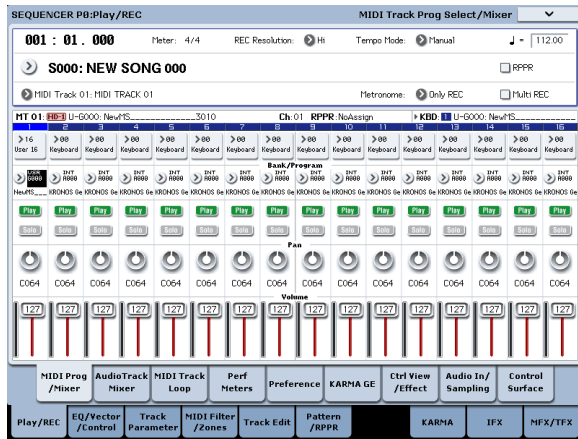

The following song data has been set/created automatically as you specified in step 5.

- P0: Play/REC page  
Song: 000, Meter: 4/4, Tempo: 112
- P0: Play/REC– MIDI Track Prog Select/Mixer page  
Track01 Program: as desired (for instance, U-G000)
- P5: Track Edit, Track Edit page  
Track01: track data: 8 measures (D2–)

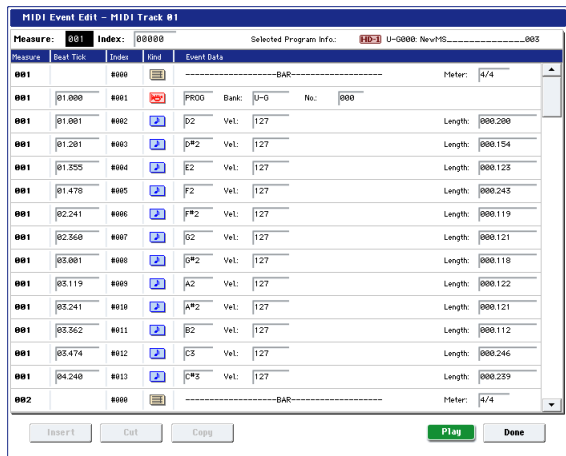

Press the SEQUENCER START/STOP switch to start playback.

As an example, set “♩(Tempo)” to 100. Notice that the pitch does not change when you play back at a different tempo.

If the beat of the original rhythm loop sample is not reproduced correctly when you change the tempo, or if obtrusive noise is heard, this is because the sample was not sliced appropriately in step 4. The way in which the percussion instrument sounds were divided will have a major impact on the quality of the playback when the tempo is changed. You will need to adjust the way in which the samples are divided in step 4.

The silence between samples may become obtrusive if you play back at a slower tempo, or noise may occur between samples if you play back at a faster tempo. To avoid such problems, you can set Stretch “New BPM” or “Ratio” in step 5 to the tempo at which you want to play back, and execute time stretch to adjust the length of each sample. For more information, see “Time Stretch” on page 747 of the Parameter Guide.

**8. In “Song Select,” choose 001.**

The following song data has been set/created automatically as you specified in step 5.

- P0: Play/REC page  
Song: 001, Meter: 4/4, Tempo: 112, RPPR: On
- P0: Play/REC– MIDI Track Prog Select/Mixer page  
Track01 Program: as desired (for instance, U-G001)
- P5: Pattern/RPPR, RPPR Setup page  
Key: C#2, Assign: On,  
Pattern: User, U00, Track: Track01  
Pattern data: 1 measure (D2–)

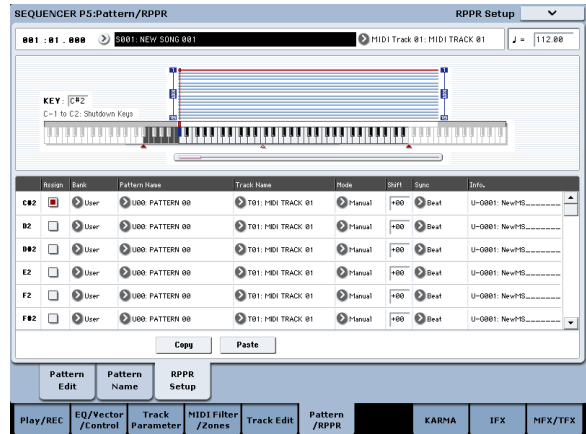

In the P0: Play/REC– MIDI Track Prog Select/Mixer page, press the C#2 key. The RPPR function will begin playing pattern U00.

In the P5: Pattern/RPPR, Pattern Edit page, press the SEQUENCER START/STOP switch to start playback of pattern U00.

When you press the C#2 key in the P5: Pattern/RPPR, RPPR Setup page, the RPPR function will start playing pattern U00.

In the same way as in step 7, changing the playback tempo will not affect the pitch.



## Sample waveform editing

In the P1: Sample Edit screen you can do the following things.

- You can set the Edit Range **Start** and **End** while watching the waveform. You can use functions such as Zoom In/Out, Use Zero, and Grid to edit the waveform efficiently.
- You can edit the sample waveform using a variety of commands such as cut, copy, mix, insert, normalize, volume ramp, and reverse.
- A Rate Convert function lets you lower the sampling frequency of the sample data in a range of 2/3 to 1/6, producing “down-sampled” effects.
- The Link function (Link: with crossfade) lets you connect two samples into one. When doing so, you can apply a crossfade so that the sustained portion of the samples will change gradually to create a natural transition between the two samples.

### 1. Select the sample that you wish to edit.

Use **Sample Select** or **Index** in the P1: Sample Edit page or the P0: Recording, Recording page to select the sample.

 If you use **Sample Select** to select the sample, be aware that the index assignment will also change.

### 2. Select the P1: Sample Edit page.

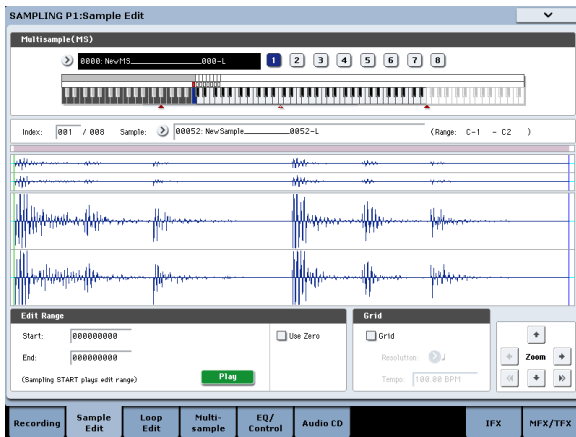

The waveform data of the currently selected sample will be displayed.

Sample waveforms recorded with **Sampling Mode** set to Stereo will be shown in two lines. The upper line is the Left channel waveform, and the lower line is the Right channel waveform.

### 3. Use “Edit Range Start” and “End” to specify the range that you wish to edit.

The selected range will be highlighted.

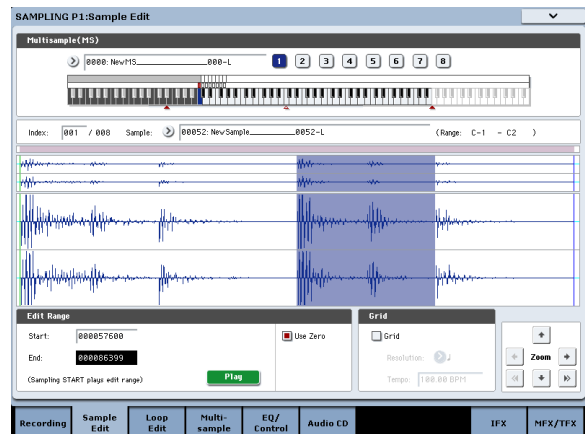

If you want to audition the selected region, press the Play button in the LCD or the SAMPLING START/STOP switch. The selected region will play at the pitch of the base key (the blue key in the keyboard display). You can specify the base key by holding down the ENTER switch and playing a note on the keyboard.

When you play a key to which the sample is assigned (the highlighted range of the keyboard displayed in “Keyboard & Pad”), the sample will be played back according to its loop settings.

The procedure for using the ZOOM and “Use Zero” check boxes is the same as for P2: Loop Edit.

### 4. From the list of page menu, select the desired editing command. Make the appropriate settings in the dialog box, and press the OK button to execute.

For details on the many sample editing features, see “Sampling: Page Menu Commands” on page 727 of the Parameter Guide.



## Multisample editing

Editing a multisample is accomplished with a number of operations i.e. creating indexes for the multisample and assigning a sample to each index, editing operations such as deleting, copying, and inserting indexes, and detailed settings such as sample level and pitch for each index.

Multisample editing is performed in P3: Multisample.

You can also do some basic edits in the P0: Recording–Recording page.

### Editing the indexes

To change the number or order of the indexes, use the Insert, Cut, Copy, and Create buttons.

#### 1. Select the P3: Multisample Edit page.

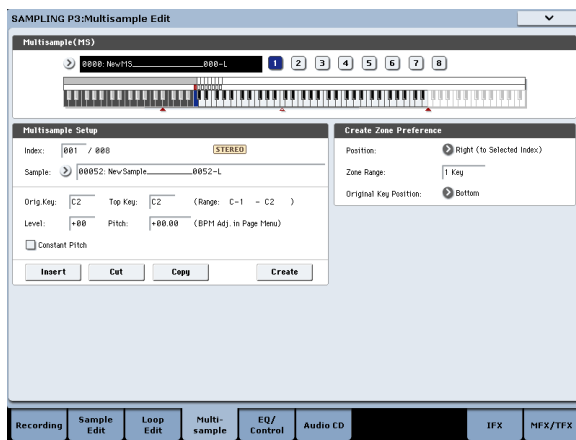

#### 2. Use “Multisample (MS)” to select the multisample that you wish to edit.

#### 3. Select the “Index.”

You can also select an index by holding down the VALUE controller or ENTER switch and playing a note on the keyboard.

#### 4. Press the buttons to modify the number or order of the indexes, and edit them.

To delete the selected index, press the Cut button.

The Insert button is used in conjunction with the Cut and Copy buttons. The contents of the index that was Cut or Copied will be inserted.

The Create button has the same function as the Create button in P0: Recording (see “Creating multisample indexes and sampling–P0: Recording” on page 141).

### Modifying the settings of an index

#### 1. Make the settings described in steps 1–3 of “Editing the indexes.”

#### 2. Set parameters for the selected index.

- Use **Sample** to specify the sample for the selected index. You can also select a sample here.
- Use **Orig. Key** (Original Key) to specify the original key of the sample.
- Changing the **Top Key** will change the upper limit of the zone. Simultaneously, the lower limit of the next-numbered index will also change. **Range** indicates the zone determined by the **Top Key** setting.
- **Level** adjusts the playback level of the sample. You can use this to ensure that all samples in a multisample have a consistent level.
- If you check **Constant Pitch**, all notes in the index zone will sound the sample at its original pitch.
- **Pitch** adjusts the sample pitch for each index. You can use the **Pitch BPM Adjust** page menu command to set the loop interval to the desired tempo. For more information, see “Pitch BPM Adjust” on page 751 of the Parameter Guide.

### EQ and controllers

The P4: EQ/Controller page lets you use a mid-sweepable three-band EQ to adjust the sound. You can also use the control surface to control the EQ. Note that this is for temporary use in Sampling mode only; it does not affect the sample data itself.

Here you can also assign the functions of SW1/2, Real-Time Knobs 5–8, and the note numbers and velocities played by pads 1–8.

## Sampling from an Audio CD

The KRONOS allows you to “rip” digital audio data from an audio CD inserted in a connected USB CD drive. To do so:

#### 1. Go to the Sampling P5: Audio CD page.

Press the SAMPLING button, and then press the Audio CD tab in the LCD screen.

#### 2. Insert an audio CD into the connected USB CD-R/RW drive.

Next, make a few settings so that you can monitor the CD-R/RW Drive Audio Input. These settings don’t affect the ripping process itself.

#### 3. For both the left and right channels, set Bus Select (IFX/Indiv.) to L/R, and Level to 127.

#### 4. Set the left channel’s Pan to L000, and the right channel’s Pan to R127.

#### 5. In “Drive” (Drive Select), choose the drive that contains the audio CD.

#### 6. Raise the Volume.

#### 7. Use Track to select the track that you want to rip.

#### 8. Press the SEQUENCER START/STOP switch to play back the audio CD track.

#### 9. During playback, press the ENTER switch at the points where you want ripping to begin and end.

This will set **Range Start** and **Range End**.

If you press the ENTER switch three or more times, **Range Start** and **Range End** will respectively be set

The method given above applies when something other than **Range Start** or **Range End** is selected (highlighted).

If **Range Start** or **Range End** are selected (highlighted), the setting will be updated each time you press the ENTER switch.

If **Range Start** or **Range End** are selected (highlighted), this region will play back.

When you finish making settings, press the SEQUENCER START/STOP switch to stop playback of the audio CD.

### 10. Verify the region that will be ripped.

Select either “Region Start” or “Region End” (the display will be highlighted), and press the SEQUENCER START/STOP switch. The CD will play from **Range Start** to **Range End** and then stop.

If you want to adjust the location, use the VALUE controllers to modify the **Range Start** or **Range End** settings, or move the cursor to a parameter other than **Range Start** and **Range End** and repeat step 8 to make the setting once again.

If you want to move the track playback start location to the beginning of the track, press the LOCATE switch.

### 11. When you have finished setting Range Start and Range End, select the page menu command “Destination.”

A dialog box will appear.

Specify the destination to which the ripped sample will be written.

Select RAM if you want to rip the sample into RAM memory. In this case, you can also set Sample No. (L),

(R) to specify the sample number that will be written. Normally you can leave this unchanged.

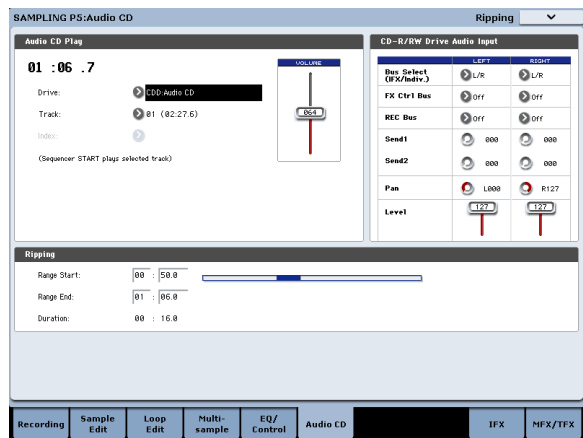

Select DISK if you want to rip the sample to media.

Use “Drive Select” to select the drive, and use the Open and Up buttons to select the directory in which the data will be saved. Also specify a name for the WAVE file that will be saved.

### 12. Press the OK button to execute ripping, or press the Cancel button to cancel without executing.

When you press the OK button, the “Obey Copyright Rules” dialog box will appear.

### 13. Carefully read the COPYRIGHT WARNING in the Quick Start Guide, and if you consent to the terms, press the OK button to begin ripping. If you do not consent to the terms, press the Cancel button to cancel the operation.

## Saving, converting to Programs, and Comparing

### Saving Samples and Multisamples

Any Samples and Multisamples that you create or edit in Sampling Mode **must be saved in Disk mode**, or they’ll go away when you turn off the power. This is different from Programs and Combinations, which can be written to memory. For more information, see “Some types of data must be saved to disk” on page 196.

To save only the Samples and Multisamples, use the **Save Sample Data** menu command on the Disk– Save page.

If you want to create an archive of the current setup, including any Programs, Wave Sequences, or Drum Kits which use the sample data, we recommend that you use **Save All** in order to ensure that the sounds will be reproduced correctly the next time you load them.

For more information, see “Saving to disks, CDs, and USB media” on page 196.

### KSC Files and User Sample Banks

KSC stands for Korg Sample Collection. KSC files are saved to and loaded from disk; they group your Samples and Multisamples together, and let you load them as User Sample Banks.

User Sample Banks may be loaded either into RAM, or may use Virtual Memory, just like EXs. They have other benefits as well. For more information, see “Creating and saving .KSC files” on page 175.

### Converting a Multisample to a Program

In pages P0: Recording–P4: EQ/Controller, you can use the **Convert MS To Program** page menu command. When you execute this command, the settings of the currently selected Multisample will be converted into a Program. In Program mode you can make filter, amp and effect settings etc., and play the sample as a program. The resulting Program can be used in a combination or song.

If you want to use a Multisample created in Sampling mode as a Program, go to the Program P2: OSC Pitch page and select RAM Mono or RAM stereo as the **Bank** for OSC1 Multisample/Wave Sequence or OSC2 Multisample/Wave Sequence **Bank** (when **Type** is set to Multisample). In this case, the Multisample will sound according to the settings of the program parameters.

1. Use “**Multisample Select (MS)**” to select the **Multisample that you want to convert to a Program.**
2. Choose “**Convert MS To Program**” to open the dialog box.

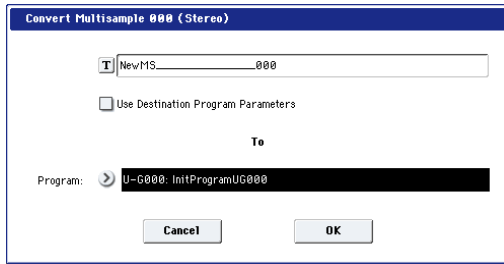

3. Press the text edit button to open the text edit dialog box, and input a new program name (up to 24 characters). By default, this will be the name of the multisample.
4. Enable or disable “Use Destination Program Parameters” as desired.

**Use Destination Program Parameters unchecked:**

When you execute the command, the multisample of the destination Program will be replaced by the multisample you select here, and the other Program parameters will be initialized so that it reproduces the sound heard in Sampling mode.

The program will be converted with an **Oscillator Mode** (Program 1–1a) of Single.

**Use Destination Program Parameters checked:**

When you execute the command, the multisample of the conversion-destination program will be replaced by the multisample you select here, but the other program parameters will not be initialized. Choose this if you want to use the parameter settings of an existing program.

-  If you check **Use Destination Program Parameters**, please be aware of the following point.

The destination program’s **Oscillator Mode** must be Single. If this is not the case, the message “Oscillator Mode conflicts” will appear when you attempt to execute the command. To solve this, change the **Oscillator Mode** setting of the destination Program.

5. Use the **To “Program”** field to specify the conversion-destination program.  
We recommend that you use Program banks USER-G or AA...GG for saving Programs created in Sampling mode.
6. Press the **OK** button to execute.
7. Press the **PROG** button to enter Program mode, select the converted program, and try it out.

## Compare

In Sampling mode, there is no Compare function that lets you return to the state prior to editing.

If you want to preserve the state prior to editing, use a function such as **Copy Sample** or **Copy MS** to copy the multisample or sample before you begin editing. For more information, see “Copy Sample” on page 728 of the Parameter Guide, and “Copy MS (Copy Multisample)” on page 730 of the Parameter Guide.

In some of the page menu commands on the Sample Edit and Loop Edit pages, you can execute with the **Overwrite** option unchecked in the dialog box, so that the sample data prior to editing will be preserved.

## Sampling in Program and Combination modes

---

### Overview

In addition to using Sample mode, you can also sample both external audio sources and internal sounds in Program, Combination, and Sequencer modes.

For instance, you can resample a performance that uses the KRONOS's full range of features, including filters, effects, Drum Track, and KARMA. You can even sample a full, multitimbral sequence, played either from the internal sequencer or an external MIDI sequencer.

You can also sample the KRONOS's performance together with audio from an external input source, or monitor the performance of the KRONOS's KARMA function and sequencer etc. while you sample only the external audio from the input jacks.

---

### Resampling a KARMA phrase in Program mode

You can resample the sound of a program or combination being played by yourself or by KARMA.

In this example, we'll explain how to sample a KARMA-generated phrase in Program mode. You can sample in a similar way in Combination or Sequencer modes as well.

1. **Press the PROG button to enter Program mode, and select the program that you want to resample.**
2. **Turn on KARMA (KARMA ON/OFF switch lit), play the keyboard, and verify that a phrase is generated.**
3. **Press the Audio In/Sampling tab to go to the P0: Play–Audio Input/Sampling page.**

Make the following settings.

– Audio Input –

“Use Global Setting”: Off

**Bus Select (IFX/Indiv.):** Off

Turn all external inputs Off.

– RECORDING LEVEL –

**Recording Level:** 0.0

This is the default setting for resampling.

– Sampling Setup –

**Source Bus:** L/R

The sound sent to the L/R bus will be resampled.

“Trigger”: Note On

Sampling will start the moment you play the keyboard.

“Save to”: RAM

Sampling will occur to RAM memory.

“Mode”: Stereo

The sound of the internal L/R channels will be sampled in stereo.

*Tip:* The KRONOS will automatically make the above settings for you if you execute the “Auto Sampling Setup– Resample Program Play” page menu command. In addition, it will also assign the Multisample to a new Program after you've finished resampling. For more information, see “Auto Sampling Setup” on page 157.

4. **Adjust the recording level.**

Press the SAMPLING REC switch and use the **Recording Level** slider to adjust the level.

Play with KARMA turned on, and use the VALUE slider to adjust the **Recording Level** slider as high as possible without allowing the “CLIP!” indication to appear.

When you've finished making adjustments, press the SAMPLING REC switch.

Press the KARMA ON/OFF switch to turn KARMA off.

5. **Sample.**

Press the KARMA ON/OFF switch to turn it on.

Press the SAMPLING REC switch.

Press the SAMPLING START/STOP switch to put the KRONOS in record-ready mode.

Play the keyboard.

Recording will start the moment you play the keyboard.

While recording continues, all the sound you produce using the keyboard or controllers will be recorded.

Press the SAMPLING START/STOP switch to stop recording.

6. **Listen to the sound you resampled.**

Go to the Sampling P0: Recording– Recording page.

Press the SAMPLING button, then the EXIT switch, and then the Recording tab in the upper line of the LCD screen.

Use “Multisample Select” to select the multisample that you resampled.

Play the C2 key to hear the resampled sound.

7. **If you want to convert this multisample into a program, choose the “Convert MS To Program” page menu command, select the desired program, and execute the conversion.**

For more information, see “Converting a Multisample to a Program” on page 154.

## Auto Sampling Setup

The KRONOS provides a lot of flexibility in sampling—which means that there are sometimes a lot of parameters to be set up. The **Auto Sampling Setup** menu command provides shortcuts to set up all of the parameters for various common sampling tasks, including resampling, sampling from the audio inputs, and restoring initialized settings.

In this example we'll explain how you can use **Auto Sampling Setup** to make the settings described under "Resampling a KARMA phrase in Program mode" on page 156.

1. Carry out steps 1 and 2 of "Resampling a KARMA phrase in Program mode" on page 156.
2. Press the Audio Input/Sampling tab to go to the P0: Play– Audio Input/Sampling page.
3. Choose the Auto Sampling Setup page menu command. A dialog box will open.
4. Make the following settings in the dialog box.  
 "Resample Program Play": On  
 This makes the appropriate settings for resampling your playing on a program.

"Save to": RAM

The resampled data will be written into RAM memory.

"Convert to Program": On

"Program": as desired

After resampling, the data will automatically be converted into the program number you specified in "Program."

5. Press the OK button to execute the command.

The KRONOS will make the appropriate settings for resampling.

6. Resample your playing as described in steps 4 and 5 of the preceding section.

7. Listen to the sound you resampled.

Go to the Program P0: Play– Main page. Press the PROG button, then the EXIT switch, and then the Main tab in the upper line of the LCD screen.

Select the program you specified for "Program" in the dialog box.

Play the C2 key and you will hear the sound you resampled.

## Mixing a KARMA drum phrase with a live guitar input, and sampling the result

Here's how you can resample KARMA together with an external audio input source.

In this example, we will explain how a guitar connected to the AUDIO INPUT jack can be played along to a drum phrase played by the KRONOS, and how both can be sampled together.

Sampling can be performed in a similar way in Combination and Sequencer modes as well as in Program mode.

1. Press the PROG button to enter Program mode, and select the drum program that you want to resample.
2. Turn KARMA on (KARMA ON/OFF switch lit), play the keyboard, and verify that the drum phrase plays.  
 Turn LATCH on. Press the LATCH switch to make it light.  
 Also adjust the tempo "♪" as desired.
3. Press the KARMA ON/OFF switch to turn off KARMA.
4. Connect your guitar to the rear panel AUDIO INPUT 1 jack.  
 Press the AUDIO INPUT MIC/LINE switch inward to select the LINE position, and set the LEVEL knob at about the center.

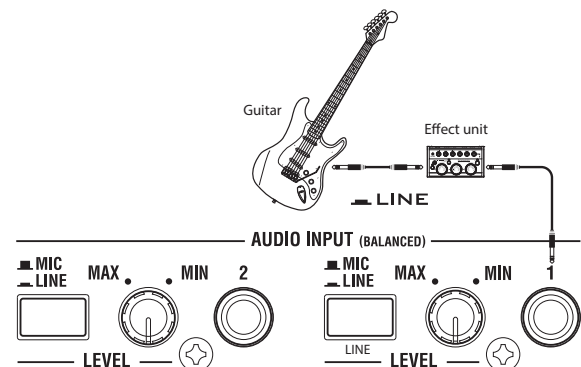

- ⚠ If you connect a guitar with passive pickups (i.e., a guitar that does not contain a preamp), you will be unable to sample it at the correct level because of the impedance mismatch. Such guitars should be routed through a preamp or an effect unit.

5. Press the Audio In/Sampling tab to go to the P0: Play– Audio Input/Sampling page.

Make the following settings.

– Audio Input –

**Use Global Setting:** Off

INPUT1

**Bus Select (IFX/Indiv.):** L/R

**Pan:** as desired

**Level:** 127

**REC Bus:** Off

The input from AUDIO INPUT 1 will be sent to the L/R bus.

– RECORDING LEVEL–

**Recording Level:** 0.0

This is the default setting for resampling.

– Sampling Setup –

**Source Bus:** L/R

The sound sent to the L/R bus will be sampled.

**Trigger:** Sampling START SW

Press the SAMPLING REC switch to enter record-standby mode. Then press the SAMPLING START/STOP switch to start sampling.

**Metronome Precount:** 4

When you press the SAMPLING REC switch to enter record-standby mode and then press the SAMPLING START/STOP switch to start sampling, a four-beat count will sound, and then recording will begin. (The metronome will not sound during recording.)

**Save to:** RAM

The sample will be recorded to RAM memory.

**Mode:** Stereo

The sound of the internal L/R channels will be sampled in stereo.

– Metronome Setup –

**Bus (Output) Select:** L/R

**Level:** as desired

The output of the metronome will be sent to the L/R bus.

**6. Play your guitar at the volume that you will be recording.**

If the display indicates “ADC OVERLOAD !” (ADC converter input overload), turn the rear panel [LEVEL] knob toward MIN to adjust the level appropriately.

The best audio quality will be obtained at the highest possible level that does not cause an overload; i.e., a level that is slightly below the point where “ADC OVERLOAD !” is displayed.

**7. Press the SAMPLING REC switch.**

Play your guitar, and the level meter will indicate the volume at which the guitar will be sampled.

Press the KARMA ON/OFF switch to turn it on, play the keyboard to start the drum phrase, and play your guitar while adjusting the final volume.

If the “CLIP!” indication appears, use the VALUE controller to lower the **Recording Level** slider (located in the right side of the display) below 0.0 to an appropriate level.

If the balance between instruments is not to your liking, use the LEVEL knob or the performance editor “Amp Level” to adjust the balance.

**8. When you have finished making adjustments, press the SAMPLING REC switch.**

Press the KARMA ON/OFF switch to turn off KARMA.

**9. Press the KARMA ON/OFF switch to turn it on, and then press the SAMPLING REC switch to enter record-ready mode.**

When you press the SAMPLING START/STOP switch, a count-down will begin. Play the keyboard during the count-down.

After a four-beat count-down, recording will start. Play your guitar. KARMA will also start after the count-down.

**10. Press the SAMPLING START/STOP switch to stop recording.****11. Press the KARMA ON/OFF switch to turn it off.****12. Listen to the sound that was sampled.**

Go to the Sampling P0: Recording– Recording page. Press the SAMPLING button, then the EXIT switch, and then the Recording tab in the upper line of the LCD screen.

Use “Multisample Select” to select the multisample that you resampled.

Play the C2 key, and you will hear the sound that was resampled.

**13. If you want to convert this multisample into a program, choose the “Convert MS To Program” page menu command, select the desired program, and execute. (See “Converting a Multisample to a Program” on page 154)**

---

## Sampling a guitar from the audio inputs, while listening to a KARMA drum phrase

Here we’ll explain how you can sample just the sound of an external input source while listening to a performance generated by KARMA.

You can do this by modifying the settings in step 5 of the preceding “Mixing a KARMA-generated drum phrase ...” to change them as follows.

INPUT1

**Bus Select (IFX/Indiv.):** Off

**REC Bus:** 1

The input from AUDIO INPUT 1 will be sent to REC bus 1.

– Sampling Setup –

**Source Bus:** REC 1/2

The sound sent to REC bus 1/2 will be sampled. The sound of the internal tone generator sent to the L/R bus will not be sampled.

**Mode:** L–Mono

The sound of the internal L channel will be sampled in monaural.

Modify the settings as shown above, sample your playing, and then listen to the sample.

## Sampling in Sequencer mode

In Sequencer mode, you can sample just like in Program and Combination modes, but there's an additional option unique to Sequencer mode: In-Track Sampling.

In-Track Sampling lets you sample an audio source that's being played along with the song. During the sampling process, the system will automatically create a Program to hold the new sample, and MIDI notes to play it in sync with the song. You might use this to record a vocal or guitar part, for instance.

## In-Track Sampling

In this example, we'll show the sound of a guitar connected to the AUDIO INPUT 1 jack can be added to your song.

**1. In Sequencer mode, select the song to which you want to add the guitar sound.**

You can either create a song, or use Disk mode to load a previously-created song.

**2. Connect your guitar to the rear panel AUDIO INPUT 1 jack.**

Press the AUDIO INPUT MIC/LINE switch inward to select the LINE position, and set the LEVEL knob at about the center.

 If you connect a guitar with passive pickups (i.e., a guitar that does not contain a preamp), you will be unable to sample it at the correct level because of the impedance mismatch. Such guitars should be routed through a preamp or an effect unit.

**3. Go to the Sequencer P0: Play/REC– Audio Input/Sampling page.**

**4. We will be modifying the Audio Input settings, so turn the Input “Use Global Setting” off.**

**5. Choose the Auto HDR/Sampling Setup page menu command.**

The dialog box will appear.

**6. Choose “In-Track Sampling.”**

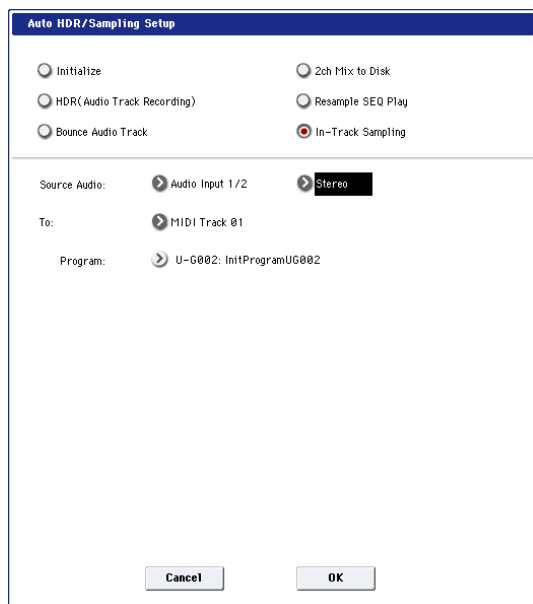

**7. Make the following settings for “In-Track Sampling.”**

**Source Audio:** Audio Input 1/2

The input from the AUDIO INPUT 1 and 2 jacks will be sampled.

**Mono–L/Mono–R/Stereo:** Mono-L

The sound will be sampled in mono.

**To:** as desired

The track you want to use for In-Track Sampling. MIDI note data to trigger the sample will be recorded in the track you selected.

**Program:** as desired

The convert-destination program number. When sampling is completed, a new multisample will be automatically created, converted to a program, and assigned as the program for the track.

**8. Press the OK button to execute the command.**

Preparations for In-Track Sampling are now completed.

Let's take a look at the settings that were made.

– Audio Input –

INPUT1

**Bus Select (IFX/Indiv.):** Off

**Pan:** L000

**Level:** 127

**REC Bus:** 1/2

The input from AUDIO INPUT 1 will be sent to REC bus.

– RECORDING LEVEL–

**Recording Level:** 0.0

This is the default setting for sampling.

– Sampling Setup –

**Source Bus:** REC 1/2

The sound sent to REC 1/2 bus will be sampled.

**Trigger:** Sampling START SW

Press the SAMPLING REC switch to enter record-standby mode. Then press the SAMPLING START/STOP switch to start sampling.

**Save to:** RAM

The sample will be recorded to RAM memory.

**Mode:** L-Mono

The sound of the internal left channel will be sampled in mono.

**9. For this example, change the settings as follows.**

**Pan:** C064

“Trigger”: Threshold, “Threshold Level”: as desired

“Sample Time”: as desired

**10. Play your guitar at the volume that you will be recording.**



If the display indicates “ADC OVERLOAD !” (AD converter input overload), turn the rear panel [LEVEL] knob toward MIN to adjust the level appropriately.

For the best sound, adjust the level as high as possible without allowing the “ADC OVERLOAD !” indication to appear.

### 11. Press the SAMPLING REC switch.

When you play your guitar, the level meter will indicate the volume at which the guitar will be sampled.

If the display indicates “CLIP!,” use the VALUE controllers to lower the **Recording Level** slider (in the right of the display) below 0.0 to an appropriate level.

### 12. When you have finished making adjustments, press the SAMPLING REC switch.

### 13. Press the SAMPLING REC switch, and then the SAMPLING START/STOP switch to enter recording-standby mode.

Press the LOCATE switch to reset the song playback location to the beginning of the song, and press the SEQUENCER START/STOP switch to play back.

Begin playing at the point where you want to record.

Sampling will begin when the **Threshold Level** volume is exceeded.

### 14. At the point where you want to stop sampling, press the SEQUENCER START/STOP switch.

Song playback and sampling will end.

Sampling will also stop if the specified **Sample Time** is reached.

### 15. Press the LOCATE switch to return to the beginning of the song, and press the SEQUENCER START/STOP switch. Notice that the sampled audio is played back along with the song.

For details on how the Compare function works for In-Track Sampling, refer to “In-Track Sampling” on page 159.

## Resampling a song to create a Wave file

You can record a completed Song to a stereo WAVE file, and then burn that WAVE file to an audio CD using a connected USB CD-R/RW drive. For more information, see “Creating and playing audio CDs” on page 206.

### 1. In Sequencer mode, select the song from which you want to create a WAVE file.

Either create a song, or use Disk mode to load a previously-created song.

 A maximum of 80 minutes for either mono or stereo can be written to media in one sampling operation (mono: approximately 440 MB, stereo: approximately 879 MB).

### 2. Go to the Sequencer P0: Play/REC– Audio Input/Sampling page.

### 3. We will be modifying the Audio Input settings, so turn the Input “Use Global Setting” off.

### 4. Choose the Auto HDR/Sampling Setup page menu command.

The **Auto HDR/Sampling Setup** dialog box will appear.

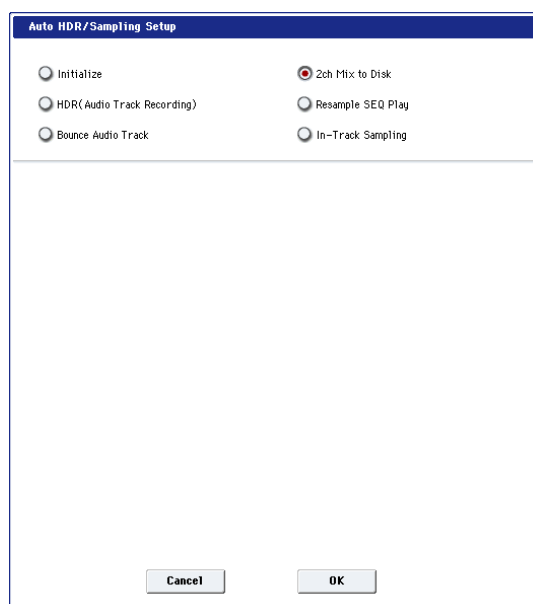

### 5. Choose “2ch Mix to Disk.”

### 6. Press the OK button to execute the command.

Preparations for In-Track Sampling are now complete.

– Audio Input –

INPUT 1 & 2, USB 1 & 2, S/P DIF L & R

**Bus Select (IFX/Indiv.):** Off

**REC Bus:** Off

Turn off the busses for all six audio inputs.

– RECORDING LEVEL–

**Recording Level:** 0.0

This is the default setting for resampling.

– Sampling Setup –

**Source Bus:** L/R

The sound sent to L/R bus will be sampled.

**Trigger:** Sequencer START SW

Press the SAMPLING REC switch and START/STOP switch to enter record-standby mode. Then press the SEQUENCER START/STOP switch to start recording.

**Save to:** Disk

The sample will be saved to the disk, directory, and file name specified in **Select Directory/File for Sample to Disk**.

**Mode:** Stereo

The sound of the internal L/R channels will be sampled in stereo.

### 7. Use the page menu command Select Directory/File for Sample to Disk to set the disk, directory, and file name for the WAVE file.

Use **Drive Select** and the Open and Up buttons to select the directory in which the WAVE file will be saved.

Press the text edit button to go to the text edit dialog box, and enter a filename.

Leave **Take No.** checked. The number at the right of **Take No.** will be input as the last two characters of the filename.

This number will increment each time you sample, ensuring that the filename will not be the same even if you sample repeatedly.

After you have made the settings, press the Done button to close the dialog box.

### **8. Set Sample Time to the length that you want to sample.**

Set this to a value slightly greater than the length of the song.

### **9. Set the Sample to Disk parameter to the desired bit depth.**

You can sample to disk at either 16-bit or 24-bit resolution.

### **10. Set the recording level.**

Press the SAMPLING REC switch.

*Note:* It will take between several seconds to nearly a minute from the moment you press the SAMPLING REC switch until the KRONOS enters standby mode (i.e., until the SAMPLING REC switch changes from blinking to lit). This time is required in order to allocate sufficient space on the disk.

Press the SEQUENCER START/STOP switch to play back the song, and adjust the sampling volume while you watch the level meters. The default setting is 0.0 dB. If the level is too low, use the VALUE controller to raise the level as high as possible without causing the "CLIP !" indicator to appear.

When you finish making adjustments, press the SAMPLING REC switch.

Press the SEQUENCER START/STOP switch to stop the song playback. Then press the LOCATE switch.

### **11. Start sampling.**

Press the SAMPLING REC switch and then the SAMPLING START/STOP switch to enter recording-standby mode.

Press the SEQUENCER START/STOP switch to play back the song. Sampling will begin at the same time.

When the song finishes playing back, press the SAMPLING START/STOP switch to stop sampling.

Use the page menu command **Select Directory/File for Sample to Disk** to verify that the WAVE file was created. Select the file and press the SAMPLING START/STOP switch to listen to the sound that was sampled.

## User Sample Banks

### Overview

User Sample Banks bring the benefits of EXs to your own sample libraries. You can load and play gigabytes of your custom or converted samples at once, using Virtual Memory. Disk and memory management is easy: you can create subsets of User Sample Banks, and mix and match parts of different banks, without duplicating samples on disk.

It's also easy to share sounds with friends and collaborators, since Programs maintain links to User Sample Banks even when samples are moved on disk or loaded onto different systems.

#### Sampling Mode and User Sample Banks

Sampling Mode and User Sample Banks are two different ways to work with your sample data, and you can switch back and forth between the two as necessary.

Sampling Mode lets you create and edit Samples and Multisamples. However, it doesn't have access to Virtual Memory. When loaded as a User Sample Bank, the samples are more like EXs; they can access Virtual Memory, but they can't be edited.

- Use Sampling Mode to create and edit your Samples and Multisamples, or to import sounds from Akai and SoundFont 2.0 formats.
- When you're done editing, load the data as a User Sample Bank in order to access Virtual Memory.
- At any time, you can load the sample data into Sampling Mode again, to edit the existing data or add more Samples or Multisamples.

Programs, Wave Sequences, and Drum Kits will remember which Multisamples and Samples they use, regardless of whether the data is loaded into Sampling Mode or as a User Sample Bank. (For more information, see "User Sample Bank IDs" on page 165.)

#### .KSC files

KSC stands for Korg Sample Collection. .KSC files contain links to Sampling Mode, EXs, and/or User Sample Bank data, including Multisamples, Samples, and Drumsamples. Loading a .KSC file loads all of the linked data.

If a .KSC includes links to Sampling Mode data, other .KSC files can link to *that* .KSC as a User Sample Bank.

For more information, see "Creating and saving .KSC files" on page 175.

### Freeing up space in RAM

To create and edit data for User Sample Banks, you'll use Sampling Mode. If you're working with a very large set of samples, you may wish to free up RAM by temporarily unloading all other sample data.

**Important:** this will clear all data from Sampling Mode, as well as un-loading all EXs and User Sample Bank data. If you have any un-saved edits to data in Sampling Mode, make sure that you save to disk before proceeding!

To free all RAM for use by Sampling Mode:

1. Go the KSC Auto-Load page.
2. Un-check all selected KSC files.
3. Press the Do Auto-Load Now button.

A confirmation dialog appears.

4. Press OK to confirm.

All sample data will be un-loaded, except for the ROM banks.

### Saving User Sample Banks

Saving a KSC file which includes Sampling Mode data automatically creates a User Sample Bank. To do so:

1. Create your own set of samples in Sampling Mode, load previously created samples, or load samples from Akai or SoundFont 2.0 formats.
2. In Disk mode, go to the Save page.
3. Select the internal disk (if you have two internal disks installed, select either one).

You can also save to a USB storage device, but in order to work as a User Sample Bank, the files must be on an internal SSD.

4. In the menu, select the Save Sampling Data command.
5. Set the Include parameter to Sampling Mode Data.

This saves everything from Sampling Mode, and keeps the KSC file clean by *not* saving links to EXs or other User Sample Banks.

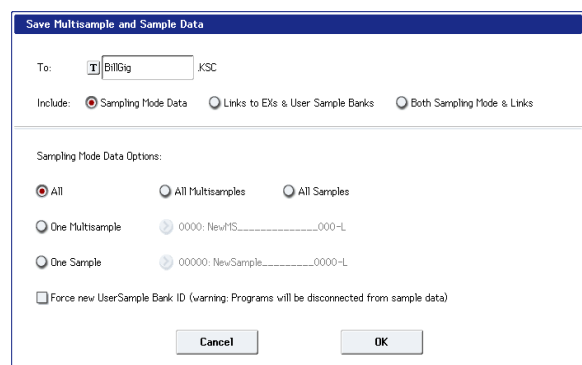

6. Set Sampling Mode Data Options to All.
7. Leave Force new User Sample Bank ID un-checked (off).
8. Give the KSC file a descriptive name.
9. Press OK to save the file.

That's it! You've now saved a User Sample Bank to the disk. To use it, you'll need to load it as described below.

### Saving creates two KSC files

When you save a KSC which includes Sampling Mode data, two KSC files are created:

- A KSC with the name you've specified, which includes the actual Samples and Multisamples from Sampling Mode.
- A second KSC which includes links to the first KSC's Sampling Mode Data, with Load Method for EXs and User Sample Banks set to Virtual Memory. The name for this KSC is the name you've specified followed by the text “\_UserBank.” For instance, if the first KSC is named BillGig.KSC, the second will be BillGig\_UserBank.KSC. This is the file that you'll load to access the sample data as a User Sample Bank.

Both files may contain references to other EXs or User Sample Banks, depending on the setting of the **Include** parameter in the Save dialog.

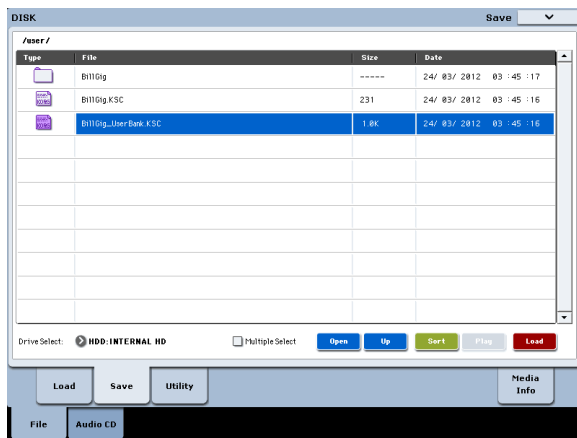

If you have Programs, Wave Sequences, etc. that you want to switch from using the original User Sample Bank to the new one, use the **Remap MS/Sample Banks** menu command to do so (you can find this on the Global Sample Management page, as well as any page with a Sample/Multisample bank select parameter).

Note that if you are a normal user (as opposed to a sound developer creating a file for distribution or sale) and you just want to add or remove Multisamples or Drumsamples—for instance, in order to save memory or create a “best of” KSC—you should NOT do this; instead, see “Creating combined or stripped-down KSCs,” below.

### Creating combined or stripped-down KSCs

The great thing about User Sample Banks is that they let you use their data by reference, instead of by copying and editing the data itself. Let's say that you have three User Sample Banks: CoverBand\_UserBank.KSC, SoloProject\_UserBank.KSC, and Experimental\_UserBank.KSC. You can then create additional KSCs to do any of the following:

- Combine all three KSCs into a single master KSC, which you can load in a single step
- Create different stripped-down versions of CoverBand.KSC, each containing the samples for a few of the songs.
- Create a “best of” KSC with only your favorite samples from the three KSCs.

All of these would take up very little additional space on the disk, don't require any editing in Sampling Mode, and don't require you to edit the original data in any way.

To combine all three KSCs:

1. **Save any data you've created in Sampling Mode. (The next step will erase all Sampling Mode data.)**
  2. **Load CoverBand\_UserBank.KSC, using the Clear All option.**
- This clears out all other sample data, so that the KSC you save later will include only the data you've just loaded.
3. **Load SoloProject\_UserBank.KSC and Experimental\_UserBank.KSC, using the Append option.**
  4. **Save a new KSC with a different name (such as Combined.KSC), with Include set to “Links to EXs and User Sample Banks.”**

This new KSC now links to all of the sample data from the three individual KSCs.

To create a stripped-down version of CoverBand.KSC:

1. **Save any data you've created in Sampling Mode. (The next step will erase all Sampling Mode data.)**
2. **Load CoverBand\_UserBank.KSC, using the Clear All option.**
3. **On the Global Sample Management page, set the Bank to CoverBand.KSC, and delete any unwanted Multisamples or Drumsamples.**
4. **Save a new KSC with a different name (such as CoverBandStripped.KSC), with Include set to “Links to EXs and User Sample Banks.”**

To create a “best of” KSC with only your favorite samples from the three KSCs:

## Saving User Sample Banks: Examples

### Revising an existing User Sample Bank

Let's say that you have a set of samples in a User Sample Bank, and you want to make a few changes to improve or expand it. You load the data into Sampling Mode and perform your edits, such as improving loop points, changing Multisample mapping, maybe even adding a few related samples.

When you save your Sampling Data, make sure that the **Force new User Sample Bank ID** option is Off (unchecked). Leaving this unchecked means that the User Sample Bank retains its identity; any Programs or other .KSC files which refer to it will continue to function as expected. For more information, see “User Sample Bank IDs” on page 165.

### Changing an existing User Sample Bank into something different

You might sometimes load data into Sampling Mode and then change a lot of the Samples and Multisamples, so that it's essentially a new set of sounds. In this case, you'll probably wish to save the result as a completely new User Sample Bank—rather than over-writing the original data. To do this, save your Sampling Data with a different name and turn On the **Force new User Sample Bank ID** option. This ensures that the original User Sample Bank, and any Programs or KSCs which refer to it, will continue to function as expected.

1. Save any data you've created in Sampling Mode. (The next step will erase all Sampling Mode data.)
2. In Disk mode, browse into the CoverBand\_UserBank.KSC file.
3. Select one or more Multisamples (Multiple Select lets you choose two or more at once).
4. Load the Multisamples using the Clear All option.

5. Load additional Multisamples or Drumsamples from other UserBank.KSC files, using the Append Option.
6. Save a new KSC with a different name (such as BestOfEverything.KSC), with Include set to "Links to EXs and User Sample Banks."

For more detailed step-by-step information on this approach, see "Creating a new KSC by loading individual Multisamples" on page 176.

---

## Loading User Sample Banks

Once saved to disk, User Sample Banks can be used much like EXs. To load a User Sample Bank:

1. Go to the folder in which you've saved your KSC from "Saving User Sample Banks," above.
2. Select the "[name] UserBank.KSC" file.
3. Press the Load button.

The Load KSC dialog will appear.

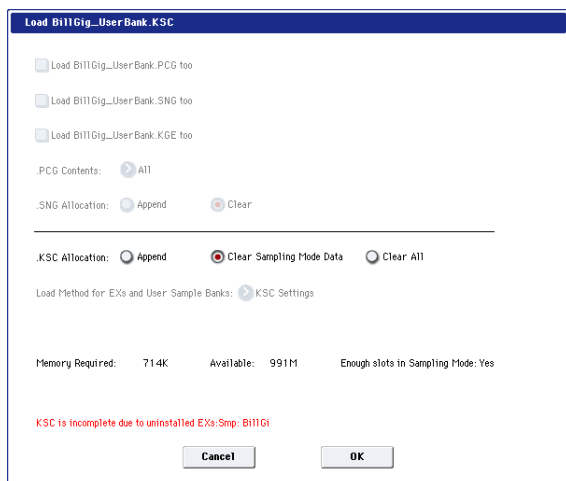

4. If you've just saved the KSC that you want to load, set .KSC Allocation to Clear Sampling Mode Data.

This will unload the data from Sampling Mode. Data in User Sample Banks can be loaded either into Sampling Mode (for editing), or as a User Sample Bank (for playback with Virtual Memory), but not both at the same time.

5. For now, leave the Load Method for EXs and User Sample Banks set to the default of .KSC Setting.

The automatically-created [name]\_UserBank.KSC file will be set to use Virtual Memory.

6. Press OK to load the User Sample Bank.

That's it! Any Programs, Wave Sequences, or Drum Kits which used the data from Sampling Mode will automatically use the same data from the User Sample Bank.

---

## Automatic loading at startup

You can use the KSC Auto-Load settings to load samples automatically at startup, as described under "Automatically loading sample data" on page 174.

---

## Editing User Sample Banks

At any time, you can load a User Sample Bank's data into Sampling Mode and edit the Samples or Multisamples as desired, or add new Samples or Multisamples. To do so:

1. If the data is already loaded as a User Sample Bank, use the "Unload all in bank" command on the Global Sample Management page to unload the data before proceeding.

For more information, see "Unloading an entire bank of data" on page 767 of the Parameter Guide.

2. Go to the folder in which you've saved your KSC from "Saving User Sample Banks," above.
3. Select the "[name].KSC" file—the one *without* "UserBank" in the name.
4. Press the Load button.

The Load KSC dialog will appear.

5. Set .KSC Allocation to Clear Sampling Mode Data.

This is important, in order to preserve the User Sample Bank ID. For more information, see "User Sample Bank IDs," below.

6. Press OK to load the data.

7. Edit as desired, but don't change the numbering of existing Multisamples (or Samples, if you've used them for Drum Kits). If you add new Multisamples or Samples, add them at the end of the list.

Programs, Wave Sequences, and Drum Kits refer to Multisamples and Samples by their number in the bank. To make sure that existing sounds continue to work properly, keep that numbering the same.

8. Save the KSC.

For details, see "Saving User Sample Banks," above.

---

## Converting older sounds

Older PCG and KSC files will continue to work just as they did previously: "RAM" sample data will load into Sampling Mode, and Programs, Wave Sequences, and Drum Kits will play that sample data. User Sample Banks offer many advantages, however, and it's easy to convert your old PCGs and KSCs with "RAM" samples to the new format. To do so:

1. Load the old-format KSC file, and the PCG(s) which use the KSC's samples.
2. Follow all of the instructions under "Saving User Sample Banks" on page 162.

3. Go to Program Mode, and select a Program which uses the KSC's samples.
4. If it's an HD-1 Program, go to the P2: OSC/Pitch page; for STR-1 or MOD-7 Programs, go to the PCM Osc page.
5. Open the menu, and select the Remap/MS Sample Banks command.

The Remap/MS Sample Banks dialog appears.

6. Set the "In" parameter appropriately.

If all of the loaded sounds use just this one KSC, select **All Programs, Wave Sequences, and Drum Kits**.

If one entire bank uses just this KSC, but other banks use different KSCs, select the appropriate bank.

If sounds within a single bank use multiple KSCs, select the **Current Program** option. For instance, some users keep all sample-related Programs in Bank USER-G, but Program 000 uses Friday.KSC, Program 001 uses Saturday.KSC, and so

on. The **Current Program** option lets you deal with each Program individually. There are similar commands for individual Wave Sequences and Drum Kits.

7. Set the "From" parameter to **Smp: Old RAM**.
8. Set the "To" parameter to **Smp:[file name]**, matching the new name for the KSC.

This is the name you created in step 8 under "Saving User Sample Banks" on page 162.

9. Press **OK**.

All references to the old RAM bank will be changed to use the new User Sample Bank.

10. If you used the "Current Program" option, make sure to **Write the Program before proceeding, and then repeat any other individual remappings as necessary**.

11. **Save a PCG file with the newly converted Program, Wave Sequence, and Drum Kit data.**

---

## User Sample Bank IDs and limitations

### User Sample Bank IDs

Under the hood, the KRONOS keeps track of User Sample Banks by a special ID saved in the KSC file. This lets the system find and recognize the User Sample Bank if you change the name or location on the disk, and even if it's used on another KRONOS altogether.

An ID is initially assigned when the samples are created in Sampling Mode. This ID stays with the data as long as you load and save using KSCs—even if you save to a different location, or with a different name. It also stays with the data regardless of whether it's loaded as a User Sample Bank, or loaded into Sampling Mode for editing.

It will not be preserved, however, if you load or save individual Samples or Multisamples.

If there are multiple files on internal disks with the same ID, the one with the most recent modification date one will be used. KSCs on USB storage devices are ignored for this purpose.

When you look at the bank name in Programs, Drum Kits, and Wave Sequences, you'll see the full file path of the associated KSC file.

### What triggers a change to the User Sample Bank ID?

Sampling Mode is given a new ID under the following circumstances:

- At system startup
- If the Clear Sampling Mode Data option is used when loading a KSC which does not include Sampling Mode data.
- When the Global Sample Management page's **Unload all in bank** command is used for Sampling Mode Data
- When the Global KSC Auto Load page's Do Auto-load Now command is used (unless one of the auto-loaded files includes Sampling Mode Data, as described below)
- On save, if **Force new User Sample Bank ID** is selected (see "Force new User Sample Bank ID," below)

Sampling Mode assumes the ID of an existing KSC under the following circumstances:

- When a KSC with Sampling Mode data is loaded using the Clear Sampling Mode Data or Clear All options, or when Sampling Mode has not been used since startup
- Similar to the above, but when loading the entire folder of Sampling Mode data when browsing within a KSC

Sampling Mode keeps its current ID under the following circumstances:

- If Sampling Mode has been used since startup, and a KSC is loaded into Sampling Mode with allocation set to Append
- When individual Samples and/or Multisamples are loaded

### Force new User Sample Bank ID

This option is available in the **Save Sampling Data** dialog, but not in the **Save All** dialog. It should be used only in special cases.

For instance, you might use **Force new User Sample Bank ID** if you have loaded a User Sample Bank, edited it substantially, and wish to save the result as a totally new User Sample Bank. After doing so, you'll also need to use the Remap MS/Sample Banks menu command to assign Programs, Wave Sequences, or Drum Kits to use the new bank instead of the old one.

---

## Limitations: KARMA Wave Sequencing and Tone Adjust

### KARMA Wave Sequencing

Due to technical limitations, KARMA Wave Sequencing selection of Multisample and Drumsample Banks supports only ROM, the current Sampling Mode data, and EXs1...EXs125.

If you need to use KARMA Wave Sequencing with your own sample data, you must load it into Sampling Mode.

### **Tone Adjust “MS Bank”**

Similarly, the Tone Adjust **MS Bank** meta-parameter supports only ROM, the current Sampling Mode data, and EXs1...EXs125. Tone Adjust **MS/WS/DKit Select** can still be used to select different Multisamples or Drumsamples from within the current bank, including EXs above 125 and User Sample Banks, as long as **MS Bank** is not used.



# Global Settings, Wave Seq., Drum Kits

## Global mode overview

In Global mode you can make overall settings that apply to the entire KRONOS, such as master tune, key transpose, effect global switch, global MIDI channel, and system clock.

In addition, you can create user Drum Kits, Wave Sequence, and Scales, make settings for the damper pedal and assignable foot switches/pedals, and specify category names for programs and combinations.

*Global mode page structure*

Page	Features
P0: Basic Setup	<ul style="list-style-type: none"><li>• Basic settings for the entire KRONOS</li><li>• Audio input settings</li><li>• Sample management</li></ul>
P1: MIDI	<ul style="list-style-type: none"><li>• MIDI settings for the entire KRONOS</li><li>• MIDI controller settings in External mode</li></ul>
P2: Controllers /Scales	<ul style="list-style-type: none"><li>• Footswitch and pedal setup</li><li>• MIDI settings for the KARMA sliders, on-screen pads, and VJS</li><li>• User scales</li></ul>
P3: Category Name	<ul style="list-style-type: none"><li>• Edit category/sub category names for Programs, Combinations and KARMA</li></ul>
P4: Wave Sequence	<ul style="list-style-type: none"><li>• Edit Wave Sequences</li></ul>
P5: Drum Kit	<ul style="list-style-type: none"><li>• Edit Drum Kits</li></ul>
P6: Options Info	<ul style="list-style-type: none"><li>• View system information</li><li>• Authorize options</li></ul>

*Note:* For details on how to access each mode and page, please see “Basic operations” on page 17.

## To save changes, you must use the Write command

 Edits to Global mode parameters will not be preserved after the power is turned off unless you first save your settings. Three types of data are handled in Global mode: Wave Sequences (Global P4), user Drum Kits (Global P5), and all other global settings (Global P0–P3). Each type of data is stored separately, and can also be saved to internal or external drives in Disk mode.

For more information, see “Writing Global settings” on page 195, “Saving to disks, CDs, and USB media” on page 196.

*Note:* the following settings are not saved by the Write command: Memory Protect, System Clock, and Effect Global SW.

*Note:* the following settings are saved automatically, regardless of the Write command: KSC Auto-Load, Auto Power-off, and the Network and Fan Control settings.

 Note that **Compare** can't be used in Global mode, except when editing Wave Sequences and Drum Kits.

# Global Settings

## Basic Setup

### Tuning and Transposing

#### Tuning to another instrument

To adjust the tuning in fine increments, in order to match other instruments or recorded music:

1. Press the **GLOBAL** button to enter **Global mode**.
2. Press the **Basic** tab to go to the **Basic Setup** page.
3. Adjust the **Master Tune** to the desired pitch.

The **Master Tune** is adjustable over a range of  $\pm 50$  cents (one semitone = 100 cents). When **Master Tune** is at 0, middle A is tuned to 440 Hz.

#### Transposing the keyboard

You can also transpose the keyboard in semitones, for quick key-changes (for instance, if the band decides to play a song in F rather than E). To do so:

1. In **Global mode**, go to the **Basic Setup** page.
  2. Adjust the **Key Transpose** as desired.
- You can adjust the transposition over a range of  $\pm 1$  octave.
3. If you're using **MIDI** or the internal sequencer, press the **MIDI** tab to go to the main **MIDI** page.
  4. Set the **Convert Position** according to whether or not you're using an external **MIDI controller** to play the **KRONOS**.

**PreMIDI** is the normal setting. This applies the transposition (as well as the velocity and after touch curves, described below) to both MIDI output from the **KRONOS** keyboard, and the internal sounds. This is also required in order to record the output of the curves into the internal sequencer.

**PostMIDI** applies the transposition and curves to incoming MIDI, for adjusting the **KRONOS** response to an external MIDI controller.

When simply playing the internal sounds from the **KRONOS** keyboard, both settings work the same.

### Velocity and after touch curves: adjusting the keyboard response

Velocity and after touch curves let you adjust the way the **KRONOS** responds to how you play on the keyboard. The default settings should work for most players, but there are many other choices to let you customize the response to match your own style.

To set the velocity and after touch curves:

1. If you're using **MIDI** or the internal sequencer, press the **MIDI** tab to go to the main **MIDI** page.
2. Set the **Convert Position** according to whether or not you're using an external **MIDI controller** to play the **KRONOS**.

See "Transposing the keyboard," above, for details on **Convert Position**.

3. Press the **Basic** tab to go to the **Basic Setup** page.
4. Set the **Velocity Curve** to suit your playing style.

Velocity Curve 4 is the default, and should work for most players.

Curve 9 is designed specifically for playing piano sounds from the weighted RH3 keyboards in the 73-note and 88-note models.

For details on the other curves, see the graphic below, as well as "Velocity Curve" on page 754 of the Parameter Guide.

#### Velocity curves

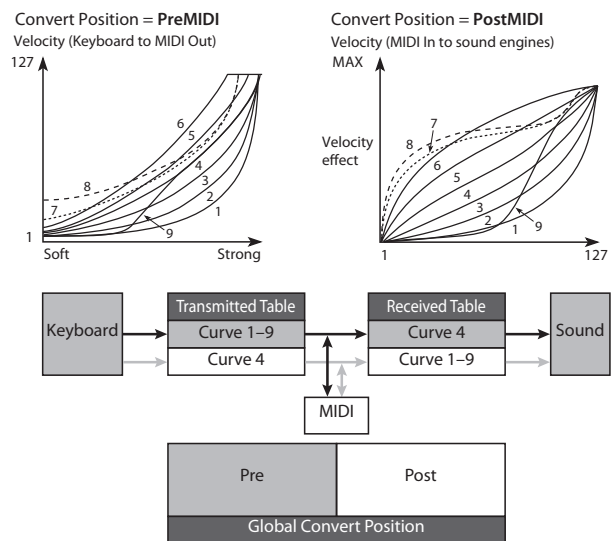

5. Set the **After Touch Curve** to suit your playing style.

After Touch Curve 3 is the default, and should work for most players.

Curve 1 requires greater amounts of pressure, while Curve 5 produces effects with only light pressure. Curves 6-8 are for special purposes; for more details, see "After Touch Curve" on page 754 of the Parameter Guide.

#### After Touch curves

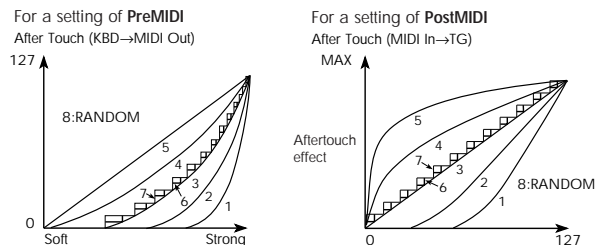

### Bypassing the effects

Insert effects, master effects, and total effects can be bypassed globally. This applies to the entire **KRONOS** regardless of the mode. For example, if you've connected the **KRONOS**'s outputs to an external mixer and are using an external effect processor to apply reverb or chorus to the sound, you can turn off the **KRONOS**'s master effects and total effects.

If the Effect Global SW **IFX 1–12 Off**, **MFX1&2 Off**, and **TFX1&2 Off** items are checked, the insert effects, master effect, will respectively be bypassed.

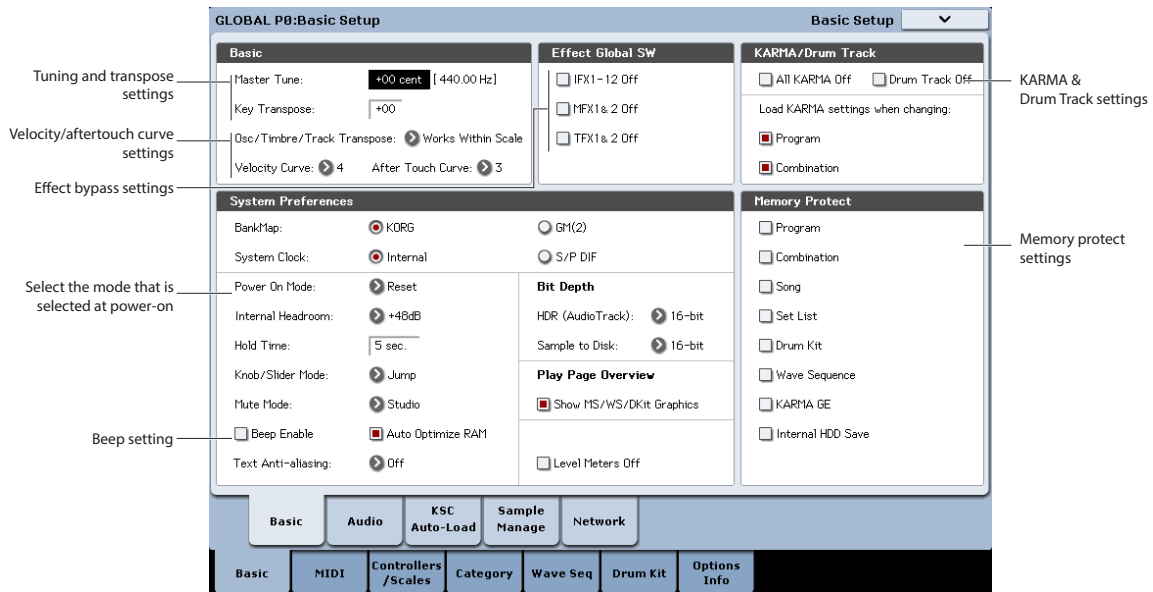

## Linking KARMA to Programs and Combinations

Each Program and Combination has its own KARMA settings, optimized for its particular sounds. Normally, these KARMA settings are loaded automatically.

In some cases, however, you may wish to keep the KARMA settings the same while trying out different sounds.

You can choose which behavior you prefer, with separate controls for Programs and Combinations, via the **Program** and **Combination** check-boxes under the heading **Load KARMA Settings When Changing**.

**On (checked)** means that when you select Programs (or Combinations), their stored KARMA Module settings will be used. This is the default.

**Off (unchecked)** means that when you select Programs (or Combinations), the KARMA Module settings will stay the same, instead of changing to the stored settings. Use this to try out a favorite KARMA-generated phrase with different sounds.

## Globally disabling KARMA and the Drum Track

If **All KARMA Off** is checked, all KARMA functionality will be disabled. KARMA will not play even if the KARMA ON/OFF switch is on.

Similarly, If **Drum Track Off** is checked, all Drum Track functionality will be disabled. The Drum Track will not play even if the DRUM TRACK switch is on.

## Interaction between Transpose and Scale

The **Osc/Timbre/Track Transpose** parameter determines how the Program Oscillator, Combination Timbre, and Song Track Transpose parameters interact with the Scale and Key. There are two options, each designed for a specific use-case.

If you are using non-equal-tempered scales and want to build parallel intervals (such as “fat fifths”) into your sounds, use the **Works Within Scale (for harmonies)** setting.

If, on the other hand, you play in non-equal-tempered scales and transpose entire songs—to accommodate singers, for example—use the **Transposes Scale** option.

For more information, see “Osc/Timbre/Track Transpose” on page 754 of the Parameter Guide.

## Recalling the last-selected mode and page at power-on

The state of KRONOS when the power is turned on will depend on the setting of **Power On Mode**.

If **Power On Mode** is set to Reset (the default), KRONOS will automatically select the Set List mode P0: Play page.

If **Power On Mode** is set to Memorize, KRONOS will power on using the same mode and page that were selected when the power was turned off.

## Sounding a beep when you press the LCD screen

If **Beep Enable** is selected, a beep will sound when you press an object in the LCD screen. Uncheck this item if you don’t want a beep to sound.

## Text Anti-aliasing

This setting controls visual anti-aliasing for the standard-size font, such as used for most parameter names. All other fonts are not affected.

**Off:** Text will have thin, sharp lines.

**Low:** Text will have thicker lines and be smoother in appearance.

**High:** Text lines will be more thick, and smoothing more pronounced.

---

### Protecting the memory

If one or more of the **Memory Protect** check boxes are checked, operations such as writing, loading, or song recording will be prohibited for the corresponding type of memory.

---

### Adjusting the brightness of the LCD

You can adjust the appearance of the LCD display by using the **LCD Setup** menu command, on the Global Basic Setup page. To do so:

1. Press the **GLOBAL** switch to enter Global mode.

2. Press the **Basic** tab in the lower line, and then the **Basic** tab located above it.

The Global Basic Setup page will appear.

3. From the page menu located in the upper right of the LCD, choose **LCD Setup**.

The LCD Setup dialog will appear.

4. Set the brightness as desired.

You can also press the **RESET CONTROLS** button to reset this to the standard value of 63.

5. Press the **OK** button to confirm the changes, or press the **Cancel** button to revert to the previous settings.

---

## Global audio settings

---

### Making default audio input settings

The Global Audio Input page controls the default mixer settings for the audio inputs, including level, pan, effects bussing, and so on. It also lets you route the main L/R outputs to a pair of individual outputs, for specific applications in live performance and recording.

Each Program, Combination, and Song can either use these Global audio input mixer settings, or have its own custom settings. This is controlled by the **Use Global Setting** parameter, on the Program, Combination, or Song's Audio Input/Sampling page.

The default for **Use Global Setting** is **On** (checked). This lets you change freely between different Programs, Combis, and Songs without affecting the audio inputs.

Also, any edits made in the mode's Audio Input/Sampling page will affect the Global setting, and vice-versa.

On the other hand, it may sometimes be convenient to save a particular mixer setup with an individual Program, Combi, or Song, to set up special sub-mixer settings or effects processing for particular inputs. For example, you can set up

a Program to use a mic input with a vocoder, as described under "Vocoder (Program mode)" on page 863 of the Parameter Guide.

In this case, set the Program, Combi, or Song's **Use Global Setting** to **Off** (un-checked), and the audio inputs will use the custom settings.

With this in mind, the Global settings apply in the following situations:

- When this page (Global Audio Input) is open.
- In Program, Combination, and Sequencer modes, if the Audio Input/Sampling page's **Use Global Setting** check-box is **On** (checked). This can be set independently for each Program, Combination, and Song.
- In other pages of Global mode, if you switch to Global mode from a Program, Combi, or Song with **Use Global Setting** set to **On** (checked).
- Similarly, in Disk mode, if you switch to Disk mode from a Program, Combi, or Song with **Use Global Setting** set to **On** (checked).

---

## MIDI settings

---

### Global MIDI Channel

The Global MIDI Channel is the most important MIDI-related setting in the KRONOS. It determines the main MIDI channel used for both Program and Combination modes, for instance. To set the Global MIDI Channel:

1. Go to the **Global P1: MIDI** page.
2. In the **MIDI Setup** section, set the **MIDI Channel** as desired.

---

### MIDI Clock synchronization

The KRONOS can use its own internal tempo, or synchronize to external clocks from either MIDI or USB.

The two best general-purpose settings are **Auto MIDI** and **Auto USB**. These combine the functionality of **Internal** and **External MIDI/USB**, so that you don't have to manually switch between the two:

- If external clocks are being received, they control the KRONOS tempo.
- If external clocks are not being received, the KRONOS uses its internal tempo instead.

---

### Synchronizing to a USB-connected computer

If you want to synchronize the KRONOS tempo to a computer connected via USB:

1. Go to the **Global P1: MIDI** page.
2. In the **MIDI Setup** section, set the **MIDI Clock** to **Auto USB**.
3. Use the **Write Global Setting** menu command to save the **MIDI Clock** setting.

For more information, see "Writing Global settings" on page 195.

---

### Synchronizing to a MIDI-connected computer

If you want to synchronize the KRONOS tempo to a computer connected via MIDI:

1. Go to the **Global P1: MIDI** page.
2. In the **MIDI Setup** section, set the **MIDI Clock** to **Auto MIDI**.
3. Use the **Write Global Setting** menu command to save the **MIDI Clock** setting.

For more information, see “Writing Global settings” on page 195.

## External Controllers

You can use the control surface to transmit MIDI CC messages to external MIDI devices. Each slider, knob, and switch can be assigned to a separate MIDI controller and MIDI channel.

You can create up to 128 different External Setups. For instance, you might make one setup for controlling several different pieces of MIDI gear on stage, another for controlling a software synthesizer (such as one of Korg’s Legacy Collection synths), and so on.

### Creating an External Setup

To create a new External Setup:

1. Go to the **Global P1: MIDI** page, and press the **External1** tab.

The **External1** page appears, with MIDI channel and CC assignments for each of the Control Surface sliders, knobs, and switches.

2. At the top of the page, set the **External Mode Setup** parameter to the **External Setup** that you’d like to edit.

3. Set up each slider, knob, and switch as desired.

Sliders and knobs send the full range of CC values, from 0 to 127. Switches just send a value of 0 when they’re turned off, and 127 when they’re turned on.

**Gch** means that the slider will transmit on the Global MIDI Channel.

4. Use the **Write Global Setting** menu command to save the new **External Setup**.

For more information, see “Writing Global settings” on page 195.

### Selecting External Setups

Once you’ve created one or more External Setups, you’re ready to use it to control external devices. First, you’ll want to select the setup.

1. On the **Global External1** page, set the **External Mode Setup** parameter to the **External Setup** that you’d like to use.

2. Press the **PROG** button to enter **Program mode**.

3. Under **CONTROL ASSIGN**, press the **EXT** button.

This puts the Control Surface into External mode.

4. Go to the **Control Surface** page.

Look at the Setup parameter on the right-hand side of the display. Notice that the External Setup you selected in step 1 is still active.

5. Use the Setup parameter to select a different **External Setup**.

6. Press the **COMBI** button to enter **Combination mode**.

7. Under **CONTROL ASSIGN**, press the **EXT** button.

8. Go to the **Control Surface** page.

Look at the Setup parameter on the right-hand side of the display. Notice that the External Setup you selected in Program mode is still active. The selection stays active until you change it, regardless of what sound you select or which mode you’re in. This makes it easy to select different KRONOS sounds without disrupting any external MIDI control, and vice-versa.

## Pedal and other controller settings

The **Controllers** tab of the **Controllers/Scales** page lets you control how the footswitches and foot pedal will work, as well as setting up controller mappings for the **KARMA** controls and the chord pads.

### Setting up the Assignable Switch and Pedal

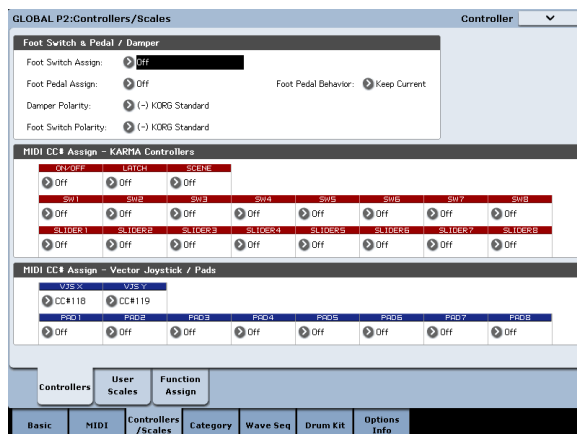

### Assignable Switch

**Foot Switch Assign** lets you assign a function to a footswitch (such as the optional Korg PS-1) connected to the rear-panel ASSIGNABLE SWITCH jack.

You can choose from the following functions:

- AMS (Alternate Modulation) source for controlling sounds
- Dmod (dynamic modulation) source for controlling effects
- Portamento on/off
- Sostenuato
- Soft pedal
- Step up or down through sounds, including Programs, Combinations, and Set List Slots
- Start/stop the sequencer
- Punch-in/out on the sequencer
- Tap tempo
- KARMA on/off
- Drum Track on/off
- Chord Mode on/off

- Select min and max values for controllers, including the joystick, ribbon, knobs, and KARMA sliders.
- Trigger chords from the on-screen pads

**Assignable Pedal**

You can specify the function that will be performed by an assignable pedal (the optional XVP-10 EXP/VEL pedal or EXP-2 foot controller) connected to the ASSIGNABLE PEDAL jack.

This is controlled by the **Foot Pedal Assign** parameter.

You can choose from the following functions:

- Master volume
- Alternate modulation source
- Effect dynamic modulation source
- Portamento pitch change speed
- Volume
- Pan
- Pan (following insert effects)
- Send levels to the master effects
- Duplicate the function of another controller, such as the joystick or ribbon

*Note:* You can use this as a source for alternate modulation or effect dynamic modulation, and use it to control program parameters or effect parameters. In this case, set **Foot Switch Assign** to Foot SW (CC#82), and **Foot Pedal Assign** to Foot Pedal (CC#04).

**Changing Programs and Combinations with the foot switch**

1. Press the “Foot Switch Assign” popup button, and select either **Program Up** or **Program Down**.

Program Up will cause the next higher program number to be selected each time you press the foot switch.

Program Down will cause the next lower program number to be selected each time you press the foot switch.

2. Set the “Foot Switch Polarity” to the polarity of the foot switch you have connected.

If you have connected a Korg PS-1 pedal switch, set this to (–) Korg Standard. If the polarity is not set correctly, the pedal will not function appropriately.

3. Either press the **PROG** switch to enter **Program P0: Play**, or press the **COMBI** switch to enter **Combination P0: Play**.

When you press the foot switch, the program/combination will change.

**KARMA, Pad, Vector**

You can assign control change messages to the KARMA switches and sliders, and to the vector joystick X-axis and Y-axis.

You can also assign either control change messages or note numbers to pads 1–8. For more details on pads and MIDI, see “Playing the pads from MIDI or the keyboard” on page 39 and “2–1c: MIDI CC# Assign —Vector Joystick / Pads” on page 782 of the Parameter Guide.

The default settings should work well in most cases. To restore the default settings, use the **Reset Controller MIDI Assign** page menu command and choose Default Setting.

**Creating user scales**

**Creating an original scale, and assigning it to a Program**

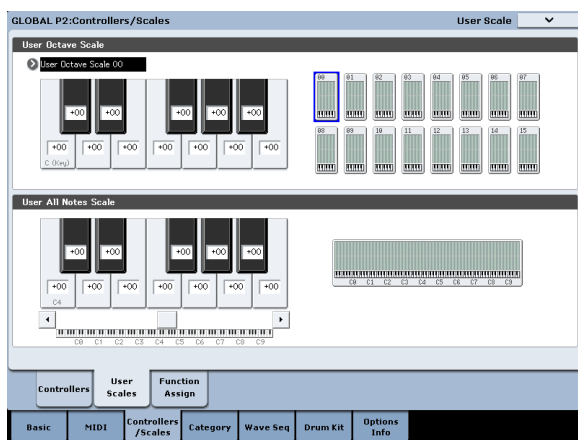

On the User Scale page, you can create your own original scales. These include sixteen different User Octave Scales, in which the pitch of each note of the octave is repeated for all octaves, and one User All Note Scale, in which the pitch of each of the 128 notes can be specified independently.

By adjusting the pitch of each key in the range of ±99 cents, you can raise or lower it by approximately one semitone relative to the normal pitch.

The user scales you create here can be used by specifying the scale for a program, for each timbre of a combination, or for each track of a song.

You can choose these scales from the following pages.

Mode	Page
Program	P1– Program Basic: Scale
Combination	P2– Pitch: Scale, Use Program’s Scale
Sequencer	P2– Pitch: Scale, Use Program’s Scale

Here is how to set the scale type for each timbre in Sequencer mode.

1. Create a user octave scale or a user all notes scale.

Select a key, and use the VALUE controllers to adjust the pitch. The range of ±99 raises or lowers the pitch approximately one semitone above or below the standard pitch.

*Note:* You can also select a key by holding down the ENTER switch and playing the desired note on the keyboard.

*Note:* You can copy one of the preset scales and edit it to create an original scale. To do so, use the page menu command **Copy Scale**.

2. Press the **SEQ** button to enter Sequencer mode.
3. Press the **Track Parameter** tab and then the **Pitch** tab to go to the **P2: Track Parameters – Pitch** page.

4. If you want the **Track** to use the scale saved with its **individual Program**, check the track’s “**Use Program’s Scale**” check box.

Tracks that are not checked will use the scale specified by Scale “**Type (Song’s Scale)**.”

5. Set “**Type (Song’s Scale)**” to select the scale for the currently selected song.

## Setting Category Names for Programs, Combinations, and KARMA

### Program, Combination, KARMA Category

The Category Name pages let you assign names to the Program, Combination, and KARMA categories and sub-categories.

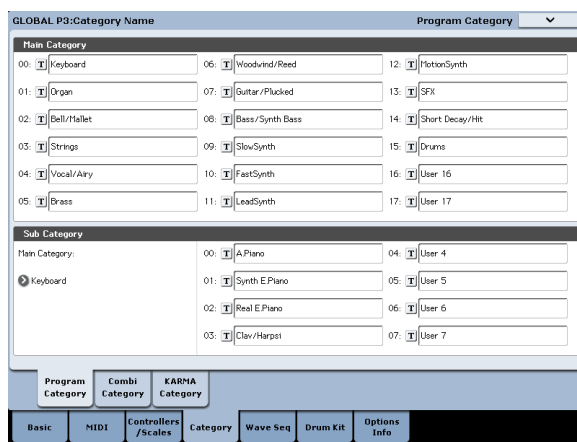

Editing the Category names is very simple:

1. Press the **T (Text)** button next to the name you’d like to edit.

The text editing dialog will appear.

2. Enter the new name, and press **OK**.

To edit a Sub Category name:

1. Choose the **Main Category** from the popup menu.
2. Edit the **Sub-Category** names as described above.



## Automatically loading sample data

### Using the KSC Auto-Load list to select which samples to load

#### What's a KSC?

KSC stands for Korg Sample Collection. KSC files contain links to Sampling Mode, EXs, and/or User Sample Bank data, including Multisamples, Samples, and Drumsamples. Loading a KSC file loads all of the linked data.

You can load KSC files in Disk mode, and the KRONOS can also automatically load one or more KSC files at startup. The Global KSC Auto-Load page lets you keep a list of your favorite KSC files, and select which ones from the list are loaded automatically at startup. You can also load KSC files immediately, without re-starting, directly from this page.

Note that you can keep files in the list without loading them. For instance, you might have one KSC file for a recording project, and a different KSC file for a live band. The list lets you keep them at hand for easy loading when desired, and may often be more convenient than using Disk mode.

**Note:** The KSC Auto-Load settings are saved automatically, and are not part of the Global PCG file.

-  Do not turn off the power for at least 10 seconds after making any changes to the Auto-Load settings. This allows the system time to complete the process, which includes saving the settings to the internal disk.

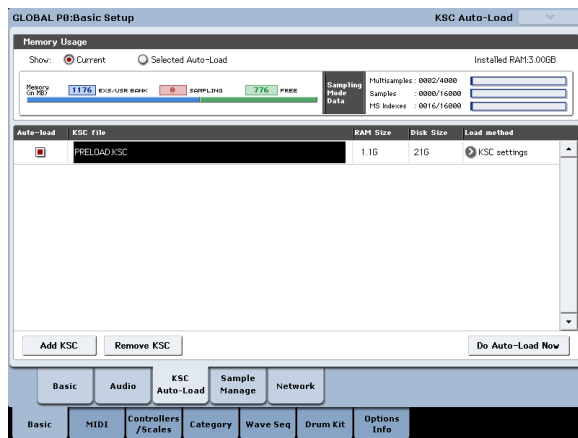

#### Adding a KSC to the list

To add a KSC to the list:

1. Go to the Global Basic—KSC Auto-Load page.
2. Press the Add KSC button.

The Add KSC file dialog appears, allowing you to select KSC files from disk.

3. Select the desired KSC files.

You can use Multiple select to choose more than one file, if desired.

4. Press Add.

The selected KSC files will be added to the list.

**Note:** When you load a KSC in Disk mode, it's automatically added to the list on a temporary basis. If you then check the KSC's **Auto-load** check-box, the KSC is added to the list

just as if it had been added by using **Add KSC**. Otherwise, any automatically-added KSCs are cleared from the list at the next startup.

#### Removing a KSC from the list

You can also remove KSCs from the list. Note that this only affects the contents of the list; it does not affect the files themselves. To do so:

1. Select the KSC file that you'd like to remove.
  2. Press the Remove KSC button.
- A confirmation dialog appears.
3. Press OK.

The KSC file will be removed from the list.

#### Selecting which KSC will be loaded

To select whether or not a KSC will be loaded:

1. Check or un-check the Auto-load box next to the KSC name in the list.

That's it! The next time that the system powers on, the checked KSC files will be loaded. You can also load them immediately, as described below.

#### Applying changes immediately

Normally, changes the auto-load settings only take effect after the next restart. You can also load and un-load KSCs immediately.

**Important:** this will clear all RAM and EXs data in memory. If you have any un-saved edits to RAM Sample or Multisample data, make sure that you save your edits before proceeding!

1. Press the Do Auto-load Now button.

A confirmation dialog appears.

2. Press OK.

Any changes you've made by adding or removing KSC files will be applied, with sample data loaded and un-loaded as necessary. Note that this may take some time to complete.

The **Do auto-load now** button is grayed out if the selected samples exceed the maximum available RAM, # of MS, # of Samples, or # of MS Indexes.

#### Loading into RAM or Virtual Memory

The **Load Method** sets the preferred way to load the KSC's samples: load them entirely into RAM, or use Virtual Memory.

Note that if the data is extremely large, and would not fit into RAM regardless of which other samples were loaded, the data will use Virtual Memory regardless of this setting.

These settings apply only to EXs and User Sample Bank data; Sampling Mode data is always loaded into RAM.

**RAM:** The samples will be loaded into RAM. This has the advantage of allowing reverse sample playback.

**Virtual Memory:** The samples will use Virtual Memory. This generally allows you to load more large samples at once. Note that the samples may still require a significant amount of RAM.

**KSC Settings:** KSCs can store separate load method settings for each Multisample or Drumsample, based on the settings when the KSC was saved. Setting **Load method** to **KSC Settings** uses these individual settings.

---

## Memory usage graphic

This shows the amount of memory used by the different types of samples, along with the slots used for Sampling Mode Multisamples, Samples, and Multisample Indexes (key zones within Multisamples).

### Show Current or Selected Auto-Load

This selects whether the graphic shows the current state of memory, or the state of memory as it would be after doing an auto-load using the current settings.

It's possible for different KSC files to refer to the same sample data; for instance, two KSC files may point to the same set of Grand Piano multisamples. The system takes note of this, so that the redundant data is counted only once.

**EXS/USR BANK** shows the amount of memory used for samples in EXs and User Sample Banks.

**SAMPLING** shows the amount of memory used for samples in Sampling Mode.

**Free** shows the amount of memory still available.

The next section shows the numbers of Multisamples, Samples, and Multisample Indexes currently used in Sampling Mode, out of the available maximum. Data in EXs and User Banks does not count towards these maximums.

**Multisamples** shows the current number of Multisamples in Sampling Mode, out of the maximum of 4,000.

**Samples** shows the number of Samples in Sampling Mode, out of the maximum of 16,000.

**MS Indexes** shows the total number of Indexes in all Multisamples in Sampling Mode, out of the maximum of 16,000.

### Memory capacity exceeded

If the size of the sample data in MB adds up to greater than the total available memory, then there are several indications in the graphic:

- The **Free** box turns red, and shows the amount by which the selected data exceeds the available memory, as a negative number
- The word **OVER** appears in red to the right of the Free box, with three exclamation points on a second line

### Max numbers exceeded for Sampling Mode Multisamples, Samples, or Multisample Indexes

As noted above, Sampling Mode can have up to 4,000 Multisamples, 16,000 Samples, and 16,000 Multisample Indexes. If any of these limits would be exceeded by the selected auto-load, then there are two indications in the graphic:

- The numbers for the affected data type (e.g., number of Samples) are shown in red
- The bar-graph for the data type turns red, instead of blue, and extends to fill the entire length

---

## Creating and saving .KSC files

---

### Creating a subset of PRELOAD.KSC

You may decide that you want to remove some of the factory-loaded samples from memory, in order to make room for optional Korg or third-party EXs, or for your own samples. This is easy to do. You can unload an entire EXs, if you wish, or unload individual Multisamples or Drumsamples.

Unloading does not affect the data stored on disk; it only changes what is currently loaded into memory.

### Unloading an entire bank of data

To un-load an entire bank of data at once:

1. **Go to the Global P0: Sample Management page.**

This page offers tools for managing the sample data currently loaded into the KRONOS.

2. **In the menu, select the Unload all in bank command.**

The **Unload all data from selected bank** dialog will appear.

3. **Select the desired bank (such as an EXs).**

4. **Press the OK button to confirm, or Cancel to exit the dialog without making changes.**

5. **Proceed to the instructions under "Saving a KSC file," below.**

### Unloading individual items

To unload individual Multisamples, Drumsamples, or Samples:

1. **Go to the Global Sample Management page.**

2. **Above the list of sample data, select the desired Bank and Type.**

For EXs and User Sample Banks, the possible Types are Multisample or Drumsample. For Sampling Mode, the possible Types are Multisample or Sample.

3. **Select the desired items (Multisamples or Samples) from the list.**

To select two or more items at once, enable the **Multiple Select** check-box.

4. **Press the Unload button.**

A confirmation dialog will appear.

5. **Press the OK button to confirm, or Cancel to exit the dialog without making changes.**

Sample data may be shared by two or more Multisamples or Drumsamples. If a Sample is used only by the Multisample or Drumsample being unloaded, the Sample will be unloaded as well. If the Sample is used elsewhere, it will stay loaded.

---

## Creating a new KSC by loading individual Multisamples

You can also load a few Multisamples from an existing KSC, and then save out the result as a new KSC.

**Important:** this example will delete any Samples or Multisamples in Sampling Mode! Make sure that you save any data that you want to keep.

1. Go to the Disk Load page.
2. Select a .KSC file on disk.
3. Press the Open button.

You're now looking inside the .KSC file. Even though the .KSC file is just a list, pointing to other files, you can browse through it on the disk as if it contained directories. At the top level of the KSC file, you'll see one or more folders, depending on the KSC: one for Sampling Mode Data, and one for each referenced User Sample Bank or EXs. If the .KSC file doesn't have a type of data, there won't be a folder for it.

4. Select the one of the folders, and press Open to look inside.

User Sample Data will contain one or two folders, for Multisamples and Samples. Usually, there will be both.

EXs and User Sample Bank folders will contain one or two folders, for Multisamples and Drumsamples.

5. Select a folder of Multisamples, and press Open to look inside.
6. Touch the Multiple Select check-box at the bottom of the screen, so that it's checked.
7. Touch a few Multisamples to select them.
8. Press the Load button.
9. An Are You Sure message appears, to confirm that you want to load multiple files; press OK.

The Load dialog appears.

10. Set Sample & MS Allocation to Clear All.

When we save the .KSC file, we'll be including all of the loaded samples. This option lets us start with a clean slate.

11. If you're loading EXs or User Sample Bank data, set the Load Method for EXs and User Sample Banks as desired.

See "Loading into RAM or Virtual Memory" on page 174.

12. Press OK to load the Multisamples.

Now, only the selected Multisamples are loaded.

13. Un-check the Multiple Select check-box.

In order to navigate back out of the .KSC file, this must be disabled.

14. Press the Up button several times, until you're back at the root level of the disk.

15. Proceed to the instructions under "Saving a KSC file," below.

---

## Saving a KSC file

1. In Disk mode, go to the Save page.
2. In the menu, select the Save Sampling Data command.

A dialog appears. There are many options here; you can save either Sampling Mode Data, Links to EXs and User Sample Banks, or both. There are also various options for saving only a single Multisample or Sample from the user data. In this case, we're going to save everything.

3. Set Include to Both Sampling Mode & Links.
4. Set Sampling Mode Data Options to All.
5. Give the KSC file a descriptive name.
6. Press OK to save the file.

That's it! You've now created and saved your own .KSC file. You can now load this later, or set it to automatically load at startup.

If you've created this .KSC file as a subset of PRELOAD.KSC to make room for other samples, make sure to disable auto-load for PRELOAD.KSC as described under "Selecting which KSC will be loaded" on page 174.

To reload your previous set of auto-loaded samples, follow the instructions under "Applying changes immediately" on page 174.

## Connecting to computers via USB Ethernet and FTP

### Overview

You can use a separately-purchased USB Ethernet adapter and the KRONOS's built-in FTP server for fast, easy file transfer with personal computers. For instance, you can:

- back up files to your computer
- transfer samples to the KRONOS
- organize and re-name files and directories on the KRONOS internal disks

### Important: compatible USB ethernet adaptor required

The KRONOS supports a specific set of off-the-shelf USB Ethernet adapters. For a complete list, see "USB Ethernet and FTP support" on page 28.

### What's FTP?

FTP stands for "File Transfer Protocol," and is a standard way to access files over networks. You can use FTP to transfer files between the KRONOS internal disk(s) and any modern computer system.

The KRONOS is an FTP "server," and your computer will be the FTP "client." Free FTP client software is available for all modern operating systems; some may include built-in FTP support. If you don't already have FTP client software, try searching for "free ftp client" for your operating system (e.g., Windows or Mac).

After connecting, you should be able to see the internal disk(s) of your KRONOS. You can then use your FTP client software to transfer files between the KRONOS and your computer.

### Network Troubleshooting

The **Status** parameter shows the current state of the KRONOS network connection. Normal states are shown in black text, and errors are shown in red.

If the **Status** shows an error, try the following:

**1. Press the Configure button to open the Configure TCP/IP dialog.**

**2. Press OK to close the dialog.**

This will make KRONOS attempt to reconnect to the network; watch the **Status** parameter to see its progress.

**3. Make sure that all ethernet cables are connected properly.**

If possible, it's sometimes helpful to swap the cables themselves.

Network troubleshooting is outside the scope of this manual, but here are a few other things to try:

**4. If possible, use DHCP instead of manual addressing.**

**5. Try restarting the DHCP server (usually, this will be the network router).**

### Connecting to the KRONOS via FTP

On the KRONOS:

- 1. Connect a compatible USB ethernet adaptor.**
- 2. Connect an ethernet cable from the adaptor to your local network.**

For connection to a wireless network, you'll need to use a wireless-to-ethernet bridge.

- 3. Go to the Global 0-5 Network page.**

This page lets you set up the USB ethernet connection and configure the FTP server.

- 4. Set the User Name and Password as desired.**

The user name must be at least one character, and can be up to 32 characters, including letters, numbers, and dashes. The password may be left blank, if you are not concerned about security; like the user name, it can be up to 32 characters.

- 5. Leave the other parameters set to their defaults.**
- 6. Note the IP address shown in the TCP/IP section.**

This will be something like 10.0.1.2, or 192.168.1.2.

You're now ready to connect to the KRONOS from your computer.

On your computer:

- 7. If you haven't already done so, install FTP client software.**
- 8. In the FTP client software, connect to the IP address from step 6 above, with the name and password from step 4.**

If you need more information about how to configure your FTP software, see its documentation.

## Using Wave Sequences

### Wave Sequence Overview

#### What's a Wave Sequence?

Wave Sequences play back a series of different Multisamples over time. You can use this to create a variety of unique timbral and rhythmic effects, as described below.

Wave Sequences are similar to Drum Kits, in that you create and edit them in Global mode, and then use them in Programs. In HD-1 Programs, you can use Wave Sequences just as you would normal Multisamples, including velocity switches or crossfades, layering different Wave Sequences on the two Oscillators, and so on.

Also like drum kits, when you play a Wave Sequence in Global mode, it will use the settings from the previously selected Program or Combi.

You can create many different effects with wave sequences, from subtle to extreme. Here are descriptions of three common uses: rhythmic Wave Sequences, crossfading Wave Sequences, and velocity-switched Wave Sequences.

#### Rhythmic Wave Sequences

Rhythmic Wave Sequences use short or abrupt crossfades, so that transitions between the different Multisamples create a rhythmic phrase. Flexible swing amount, rests, and ties let you build complex patterns, which you can then sync to KARMA and the system tempo.

#### Crossfading Wave Sequences

By using long durations and crossfade times, Wave Sequences can produce complex, evolving timbres. Modulating the Start Step, Position, and Duration makes the sound even more organic, so that every note can play the Wave Sequence a little differently.

#### Velocity-Switching Wave Sequences

By setting each step's duration to GATE, and then modulating the Start Step by velocity, you can create a sound with up to 64 velocity switches. For instance, you can use this to switch between a large number of different attack transients.

#### Wave Sequence banks

There are built-in "factory" sounds in the Internal bank (I-000 through I-149) as well as some of the user banks, as shown below. You can over-write them if you wish, but doing so may change the sounds of the factory HD-1 Programs, as well as the Combis which use them.

Other banks are empty when shipped from the factory. You can use these for storing sounds that you create yourself, optional sound banks from Korg, or third-party sound libraries. Each user bank contains 32 Wave Sequences.

##### Wave Sequence bank contents

Bank	Contents
INT 000...148	Factory Wave Sequences
INT 149	Initialized Wave Sequence
USER-A 00...24	Factory Wave Sequences
USER-A 25...31 USER-B00...E31	Initialized Wave Sequences
USER-F 00...12	Factory Wave Sequences
USER-F13...G31 USER-AA00...GG31	Initialized Wave Sequences

## Programming Basics

The Wave Sequence parameters are spread over two pages. The **Seq Parameters** page has controls for the Wave Sequence as a whole, such as the start and end steps, looping, and modulation.

The **Step Parameters** page goes deeper into the structure of the Wave Sequence, allowing you to edit each of the 64 Steps.

Programs, Combinations, and Songs also have a handful of Wave Sequence-related parameters, to make it easier to fit Wave Sequences in with other sounds and rhythmic components (such as KARMA).

The Wave Sequence graphic, shown on both the **Seq Parameters** and **Step Parameters** pages, gives you a quick overview of the sequence, at a glance:

*Wave Sequence graphic*

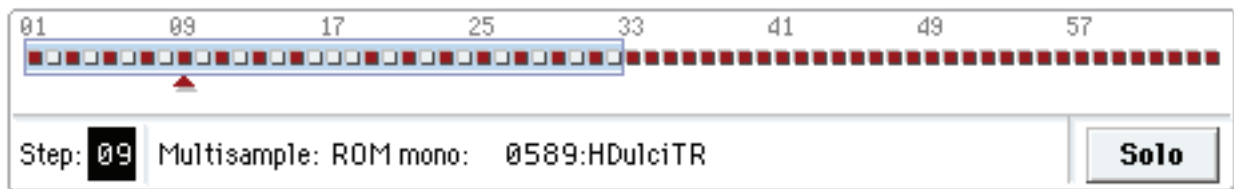

- The current step is marked by a red arrow.
- Red boxes are Multisample steps.
- Green boxes are Tie steps.
- White boxes are Rest steps.
- The length of the Wave Sequence, from the Start Step to the End Step, is shown by a rectangular outline.
- The Loop is highlighted in blue.
- On the **Step Parameters** page, the horizontal scroll-bar at the top of the graphic shows you the eight steps currently displayed on the screen.
- At the bottom right of the graphic is a **Solo** button. When this is turned on, the Wave Sequence will play only the current step, including its fade-in and fade-out.

### What's in a step?

Wave Sequences have 64 steps (although you don't have to use all of them—see “Setting the length of the sequence” on page 179). Each step includes:

- A “type” setting, which makes the step either play a Multisample, continue the previous step like a tied note, or play only silence like a musical rest.
- A selected Multisample, which sets the basic sound of the step.
- Multisample Reverse and Start Offset parameters, which modify the basic sound of the Multisample.
- Volume, coarse tuning, and fine tuning for the Multisample.
- A duration, which controls how long the step lasts. You can set the duration in either milliseconds or musical beats.
- A crossfade time, which sets how long it takes to fade into the *next* step.
- Fade-in and fade-out shapes for the crossfade, for subtle control of the transition between this step and the next step.
- Two AMS output values, which can be used to control other Program parameters.

### Setting the length of the sequence

You can use anything from 1 to 64 steps in a Wave Sequence. You also don't have to start on step 1. To set the length of the sequence:

1. Go to the **Seq Parameters** page.
2. Set the **Start Step** as desired.

You can also modulate the Start Step in real-time; for more information, see “Start Step modulation” on page 184. Modulating the start step does not change the End Step.

#### 3. Set the End Step as desired.

The read-only **Length** parameter will show you the total number of steps between the two points.

### Setting up the loop

Wave Sequences can loop, so that some or all of the steps are played repeatedly—like a drum loop, or a loop in a sequencer.

You can set the start and end of the loop separately from the start and end of the Wave Sequence itself. The loop can either play for as long as the note is played, or repeat a specified number of times. Finally, you can choose whether the loop plays forwards, plays backwards, or alternates between backwards and forwards.

To set up the loop:

1. Set the **Loop Start and End Steps** as desired.
2. Set the **Loop Direction**.

Forwards plays from the Start Step to the Loop End, and then skips back to the Loop Start.

Backwards/Forwards plays from the Start Step to the Loop End, then backwards from the Loop End to the Loop Start, and then forwards again to the Loop End, and so on.

Backwards plays from the Start Step to the Loop End, then backwards from the Loop End to the Loop Start, and then skips back to the Loop End, and so on.

#### 3. Set the Loop Repeats.

You can set the loop to repeat a specific number of times, between 1 and 127. You can also make the loop keep playing for as long as the note is held (the **INF** setting), or not repeat at all (the **Off** setting).

## Adjusting the sound of an individual step

You can make some basic adjustments to the sound of each step's Multisample, including changing its volume and pitch, making it play in reverse, and changing the sample start points.

You can also use the AMS Outputs to modulate other Program parameters outside of the Wave Sequence, such as Filter Frequency, Pan, and so on.

To edit steps:

**1. Go to the Step Parameters page.**

This page shows the parameters for eight steps at a time. Use the scroll bar at the right of the screen to change which steps are in view.

**2. In order for a step to make a sound, set its Type to Multi (Multisample).**

**3. Select a Multisample using the Bank and Multisample pop-up menus.**

Mono and stereo Multisamples are stored in different Banks. Each step can be either mono or stereo. Note that even if only one step uses a stereo Multisample, the entire Wave Sequence becomes "stereo," and uses twice as many voices - it's the price that you pay for power!

**4. Set the Level (volume) as desired.**

This can be useful for evening out the perceived levels of different Multisamples, or for accenting steps in rhythmic sequences.

**5. Set the Transpose and Tune as desired.**

**Transpose** sets the Multisample's coarse tuning, in semitones. You can use this to change the octave for individual steps, to create melodies, or to create interesting variations on percussion sounds by extreme transposition.

**Tune** controls the fine tuning, in cents (1/100 of a semitone). Small variations in tuning can create an interesting, organic feel.

**6. Use Reverse and Start Offset to change the way that the Multisample plays.**

**Reverse** plays the selected Multisample backwards, without looping. (If individual samples within the Multisample are already set to Reverse, they will still play in reverse, regardless of this setting.)

**Start Offset** lets you select from up to 8 pre-programmed sample start points (for ROM and EXs), or between the normal start point and the loop start (for Sampling Mode and User Sample Banks).

### Using Insert/Cut/Copy/Paste

You can use the **Insert**, **Cut**, **Copy**, and **Paste** buttons to copy all of the parameters from one step to another, or to move a step to a different position in the sequence.

To insert a copy of a step into the sequence:

**1. Select the step you'd like to copy.**

You can do this by touching any of the step's parameters, or by directly editing the Step parameter under the Wave Sequence graphic. The selected step is shown by a red arrow on the left side of the screen, as well as a red arrow in the graphic.

**2. Press the Copy button.**

You're now ready to insert or paste the step.

**3. Select the step which you'd like to follow the new step.**

**4. Press the Insert button.**

The copied step is inserted at the selected position. The previously selected step, and all steps following it, move down to make room for the inserted step.

To remove a step from the sequence:

**1. Select the step you'd like to remove.**

**2. Press the Cut button.**

The selected step will be removed from the sequence, and all following steps will shift up to fill in the space.

## Modulating Program parameters per step

Each step has two AMS Output values. These act kind of like step sequencers, allowing you to modulate any AMS destination in the Program. In other words, virtually any Program-level parameter can have a different setting for each step of the Wave Sequence.

For instance, to adjust the Filter Frequency separately for each step:

**1. Select the Program that you'll use for the Wave Sequence.**

**2. Go to the Filter Mod 1 tab of the Filter page.**

This page has the filter modulation parameters for OSC1.

**3. Under Filter A Modulation, set one of the AMS sources to Wave Seq AMS Out1.**

	Alternate Modulation S
Off	JS+Y (CC)
AMS Mixer 1	JS-Y (CC)
AMS Mixer 2	JS+Y & AT/2
WawSEQ AMS Out 1	JS-Y & AT/2
WawSEQ AMS Out 2	Foot Pedal (CC)
Pitch EG	Ribbon (CC)

**4. Set the Intensity as desired.**

This means that the AMS 1 output will modulate the Filter Frequency. Now, you just need to set up the Wave Sequence to send values out:

**5. Go to the Wave Sequence Step Parameters page.**

**6. For each step, enter the desired value for AMS Out1.**

**7. Go to the OSC1 Basic tab of the OSC/Pitch page.**

**8. Set MS1 to use the Wave Sequence you edited in step 5.**

The Filter Frequency will now change with every step.



You may wonder - what if the Program uses more than one Wave Sequence, and each is sending out different AMS values? Not to worry. Under the hood, each Wave Sequence actually has its own complete voice structure, which allows the AMS values to be different for each one.

### Modulating individual steps with the AMS Mixer

You can combine the Wave Sequence AMS Outputs with the AMS Mixer to modulate individual steps. For instance, you can set up SW1 to mute a particular step. We'll start by assuming that you have already set OSC1 to play the Wave Sequence. Then:

1. On the Wave Sequence Step Parameters page, set step 1's AMS Out1 to 127.
2. Set AMS Out1 for all other steps to 0.

3. Go to the AMS Mix 1 tab of the AMS Mix/C.KeyTrk page.

4. On AMS Mixer 1, set the Type to Amt A x B.

5. For AMS A, select Wave Seq AMS Out 1.

6. Set the AMS A Amount to 00.

7. For AMS B, select SW 1 Mod (CC#80).

8. Set the AMS B Amount to +99.

9. Go to the Amp 1 Mod tab of the Amp/EQ page.

10. Under Amp Modulation, set the AMS source to AMS Mixer 1.

11. Under the AMS source selection, set the Intensity to -99.

SW1 will now mute and un-mute step 1. You can use this same technique for any per-step modulation.

*Wave Sequence step Durations, Crossfade times, and Fade-In and Fade-Out shapes*

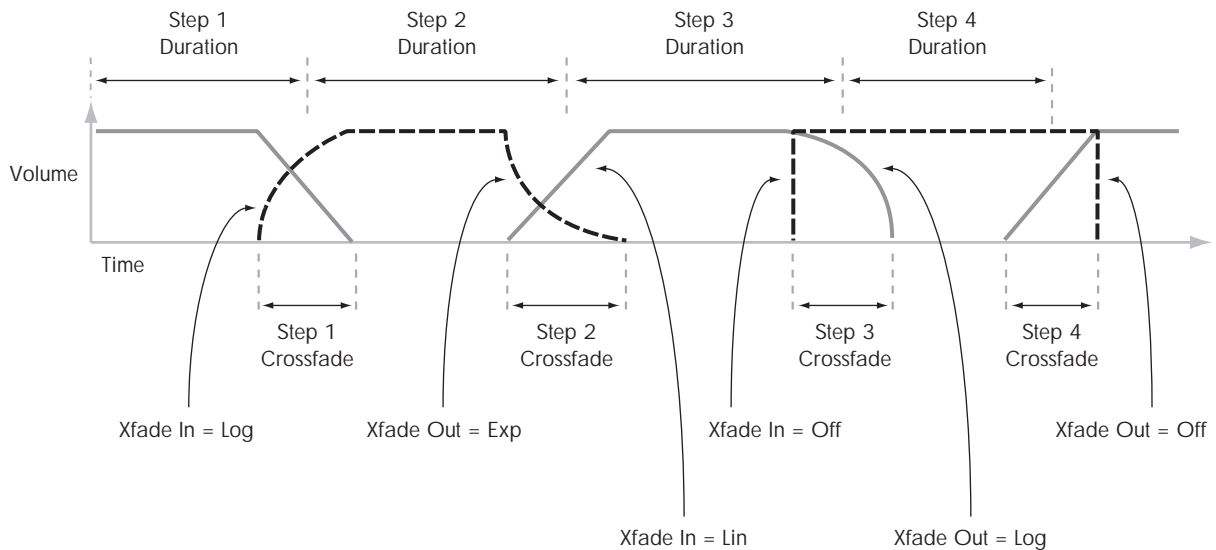

## Using rhythmic Wave Sequences

### Creating rhythmic Wave Sequences

To create a rhythmic Wave Sequence:

1. On the Seq Parameters page, set the Mode to Tempo.

This makes the Wave Sequence synchronize to the system tempo, as set by either the Tempo knob or MIDI Clock.

2. Set Run to On.

This is the default setting; the Wave Sequence will move from step to step automatically.

3. Select the Multisamples that you'd like to use, and set the Start, End, and Loop Start/End steps as desired.

4. Set the Loop Repeats to INF.

This will make the sequence repeat as long as you hold the note.

5. On the Step Parameters page, use the Base Note and Multiply ("x") parameters to set the rhythmic values for each step.

For instance, to create a dotted eighth note, set the Base Note to 1/16, and Multiply ("x") to 3.

6. Set the Step Xfade times to relatively short values, such as 0-5 ms.

This preserves the initial transients of the samples.

7. To create pauses in the rhythm, set the Step Type to Rest.

### Doubling or halving the rhythmic pulse

You may sometimes want to slow down a 16th-note rhythm so that it becomes 8th-notes instead, or vice versa. The /2 and x2 buttons make this easy.

Press the /2 button to cut the Base Note and/or Multiply settings in half, so that 1/4 notes become 1/8 notes, 1/8 notes become 1/16 notes, and so on.

Press the x2 button to multiply the Base Note and/or Multiply settings by two, so that 1/8 notes become 1/4 notes, 1/4 notes become 1/2 notes, and so on.

Note: these buttons only appear when the Mode is set to Tempo.

## Setting the tempo

Each Program, Combi, and Song has its own tempo setting. You can change the tempo simply by adjusting the front-panel TEMPO knob, or by tapping in quarter-notes on the TAP TEMPO button.

There's also a Global mode parameter which lets you switch between using the internal tempo or tempo from an external MIDI source (such as a computer-based sequencer). To sync to an external MIDI source:

1. Press the **GLOBAL** button to enter **Global mode**.
2. Select the **MIDI** tab.
3. Under **MIDI Setup**, set the **MIDI Clock** parameter as desired.

**Internal** uses the tempo stored with the Program, Combi, or Song, and set by the TEMPO knob.

**External MIDI** syncs to incoming MIDI clocks, and ignores the TEMPO knob.

**Auto** is a combination of the above. When clocks are received via MIDI, it syncs to the incoming clocks; when no clocks are being received, it defaults to the stored tempo settings.

## Using Swing

**Swing** adds a human feel to the rhythm, and provides an easy way to turn a "square" rhythm into a shuffle groove.

This works by adjusting the position of the up-beats, relative to the Wave Sequence's **Swing Resolution** setting. For instance, if the **Swing Resolution** is set to 1/8, **Swing** affects every other 8th note.

While the **Swing Resolution** is stored in the Wave Sequence, the **Swing** amount is set in the Program, Combi Timbre, or Song Track. This lets you use a single Wave Sequence in different Programs, Combis, and Songs, each with different amounts of swing.

For instance, to turn an 8th-note rhythm into a shuffle:

1. Create or select a Wave Sequence with an 8th-note rhythm.
2. On the Seq Parameters page, make sure that **Swing Resolution** is set to an 8th-note.
3. Create or select the Program in which you'd like to use the Wave Sequence.
4. Go to the **OSC1 Basic** tab of the **OSC/Pitch** page.
5. Set **MS1** to use the Wave Sequence you selected in step 1.
6. Go to the **Program Basic** tab of the **Basic/Vector** page.
7. Under **Wave Sequence**, set the **Swing** parameter to **+100%**.

This makes the 8th-notes into a triplet, shuffle pattern.

Positive values make the up-beats later, and negative values make them earlier. When **Swing** is set to **+300%**, up-beats will be moved all the way to the next down-beat. At this point, the notes on the up-beats will not be heard at all.

If you are using the Wave Sequence in conjunction with **KARMA**, you may wish to adjust **KARMA**'s swing amount as well.

## Swing with multiple Wave Sequences

If a Program contains multiple Wave Sequences with different **Swing Resolution** settings, the Program will use the finest value. For instance, if one Wave Sequence is set to **1/8** and the other is set to **1/16**, the Program will use **1/16**.

*Wave Sequence Swing*

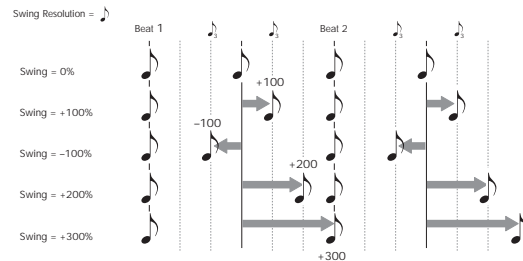

## Keeping notes in sync

By default, the Wave Sequences for each note run independently from one another, so that each note sounds as an individual voice.

With rhythmic Wave Sequences, however, you may sometimes want all of the Wave Sequences in a chord to start together and sync together, in lock-step. **KRONOS** gives you two tools to make this happen: **Key Sync Off**, and **Quantize Triggers**.

### Key Sync Off

Each Program, each Combi Timbre, and each Track in a Song has its own **Key Sync** setting. The name "Key Sync" comes from the similar setting for LFOs, meaning "restart separately for each note-on."

When **Key Sync** is **On**, each note's Wave Sequence(s) will progress independently, so that each one can be on a different step, or moving at a different rate.

When **Key Sync** is **Off**, on the other hand, all of the Wave Sequences will be synchronized on the same step. There is one exception to this, however: if **Duration** is modulated with velocity or note-number, the Wave Sequences can still progress at different rates.

To turn **Key Sync Off** in a Program:

1. Go to the **Program Basic** tab of the **Basic/Vector** page.
2. Make sure that the **Key Sync** parameter is *not* checked.

To turn **Key Sync Off** in a Combi or Song:

1. Go to the **Wave Sequence/KARMA** tab of the **Timbre Parameters** page (for Combis), or **Track Parameters** page (for Songs).

Each of the 16 Timbres or Tracks has its own **Key Sync** parameter. If you like, you can set them all separately.

2. Set the **Key Sync** check-boxes as you like.

Remember, to synchronize all of the notes, turn **Key Sync off**.

### Quantize Triggers

**Quantize Triggers** allows you to force most Tempo-mode Wave Sequence note-ons to be in sync, making it easier to play along with other rhythmic elements.

When **Quantize Trigger** is **On**, note-ons are quantized to 8th notes using the current tempo reference. (See below for a few more details.)

The tempo reference can come from different sources, depending on the current mode, and whether or not KARMA is on:

- In Program and Combi modes, if KARMA is off, note-ons are synchronized with the sounding Tempo-mode Wave Sequence, if any.
- In Program and Combi modes, if KARMA is on, note-ons are synchronized with KARMA.
- In Sequence mode during playback or recording, note-ons are synchronized with the sequence.
- In Sequence mode, while the sequencer is stopped, note-ons are synchronized with RPPR and KARMA.

Each Program, each Combi Timbre, and each Track in a Song has its own **Quantize Triggers** setting.

To turn on **Quantize Triggers** in a Program:

1. Go to the **Program Basic** tab of the **Basic/Vector** page.
2. Check the **Quantize Triggers** box.

To turn on **Quantize Triggers** in a Combi or Song:

1. Go to the **Wave Sequence/KARMA** tab of the **Timbre Parameters** page (for Combis), or **Track Parameters** page (for Songs).

Each of the 16 Timbres or Tracks has its own **Quantize Triggers** parameter. If you like, you can set them all separately.

2. Set the **Quantize Triggers** check-boxes as you like.

### Quantize Triggers

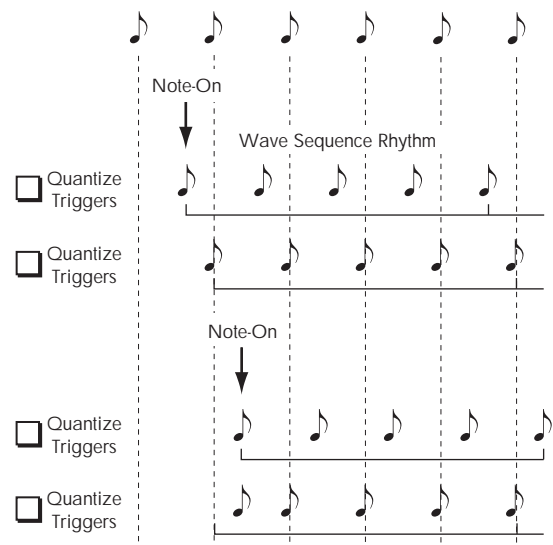

### How Quantize Triggers works

The **Quantize Triggers** feature tries to make a good guess at where you intended the note to be. If you play the note just a bit late—within a 32nd note of the 8th note—it will assume that you meant the note to sound on the beat that just passed. In this case, the note will play immediately.

On the other hand, if you play the note up to three 32nd notes early, it will assume that you're intending the note to sound on the next beat. In this case, the note-on is delayed until the next 8th note.

## Creating smooth, evolving timbres

### Crossfaded Wave Sequences

To create a smooth, crossfading Wave Sequence:

1. On the **Seq Parameters** page, set the **Mode** to **Time**.

This turns off tempo synchronization, so that you can set Wave Sequence durations in milliseconds.

2. Set **Run** to **On**.

This is the default setting; the Wave Sequence will move from step to step automatically.

3. Select the **Multisamples** that you'd like to use, and set the **Start**, **End**, and **loop** steps as desired.

4. On the **Step Parameters** page, set the **Durations** to relatively long values, **500ms** or more.

5. Set the **Xfade** parameters to long values as well.

To crossfade continually, without pausing to hear a single step on its own, set the **Xfade** times the same as the **Durations**.

Note: In **Time** mode, the actual crossfade time cannot exceed the total duration of the two steps being crossfaded. If the **Xfade** setting would exceed this limit, the crossfade time will be clipped internally.

6. Adjust the **step Levels** to smooth out perceived volume differences between different **Multisamples**.
7. Adjust the **Fade-In** and **Fade-Out** shapes to taste.

The shapes can help you to fine-tune the transitions between the steps.

### Stretching or compressing the sequence

If you like the proportions of the step durations and crossfades, but want the whole sequence to go faster or slower. The **Exp/Comp** (Expand/Compress) button makes this easy:

1. On the **Step Parameters** page, press the **Exp/Comp** button.

A dialog box will appear.

2. In the dialog box, set the **Expand/Compress %** parameter as desired.

**100%** means the current duration and crossfade times.

Values **99** and below make the times shorter, and values **101** and above make them longer.

3. Press the **OK** button.

The step durations and crossfade times will be adjusted by the selected percentage.

Note: the **Exp/Comp** button appears only when the **Mode** is set to **Time**.

You can also stretch and compress Wave Sequences in real-time, via AMS. For more information, see "Duration modulation" on page 184.

## Modulating Wave Sequences

### Position modulation

Position modulation lets you offset the Wave Sequence from the current step. If **Run** is turned **On**, The Wave Sequence will continue to progress through its steps during modulation, kind of like fast-forwarding while playing a tape or CD.

To sweep through a sequence manually, creating the distinctive sound of a famous German synthesizer:

#### 1. Set Run to Off.

This means that the Wave Sequence will stay on the current step, until you modulate the position.

#### 2. Under Modulation and Position, select an AMS source, such as the ribbon or an EG.

#### 3. Set the Intensity to a positive value to move forward through the steps, or a negative value to move backwards.

For instance, if Intensity is set to +14, the maximum amount of modulation will move 14 steps forward in the Wave Sequence.

### Position modulation and loops

Position AMS affects only the current step, and does not change the loop start or loop end. This means that Position AMS can make the Wave Sequence jump into the middle of the loop, or jump back out of the loop again.

### Duration modulation

Duration modulation lets you dynamically control the step duration and crossfade times. You can speed up or slow down the Wave Sequence so that it runs between 1% and 400% of the original rate.

By using Velocity, key tracking, or note number as the AMS source, you can make the Wave Sequences on every note have slightly different timing (or dramatically different timing, for that matter!) This can be very useful for making a cross-faded Wave Sequence sound more organic. For instance, to make the Wave Sequence move faster when you play at higher velocities:

#### 1. Go to the Sequence Parameters page.

#### 2. Under Modulation and Duration, select Velocity as the AMS source.

#### 3. Set the Intensity to a value less than 100%, such as 90%.

Values below 100% make the durations shorter, so the Wave Sequence moves more quickly. Values above 100% make the durations longer, so the sequence moves more slowly.

### Start Step modulation

You can use a MIDI controller, such as Velocity, to select a different start step for each note, to introduce more variety into the timbre. You can move the start step either forwards or backwards. For instance:

#### 1. Make sure that Note-On Advance is Off.

When **Note-On Advance** is **On**, **Start Step** modulation is disabled.

#### 2. Set the Start Step to 10, and the End Step to 25.

#### 3. Set the Loop Start and Loop End to the same points – 10 and 25.

The sequence will now loop through 16 steps, from 10 to 25.

#### 4. Set the Start Step AMS (to the right of the Start Step parameter) to Velocity.

#### 5. Set the Intensity to –9.

Playing at the highest velocities will now start the sequence at step 1 (moving it forward by 9 steps); at the lowest velocities, the sequence will still start at step 10.

In general, negative modulation moves the Start Step earlier in the sequence, to the limit of Step 1. Positive modulation moves the Start Step later in the sequence, to the limit of the End Step.

### Note-On Advance

This feature lets you advance the start point of the Wave Sequence by one step with each new note-on. If **Loop Repeats** is not set to **Off**, **Note-On Advance** will step through the loop, paying attention to the loop direction and number of repeats.

For instance, let's say that the Wave Sequence **Start Step** is **2**, and the **End Step** is **6**. Also, the **Loop Start** is set to **3**, the **Loop End** is set to **5**, and the **Loop Direction** is set to **Forward**.

If **Repeat Times** is **Off**, **Note-On Advance** will make the Wave Sequence play as follows:

1st note: 2, 3, 4, 5, 6

2nd note: 3, 4, 5, 6

3rd note: 4, 5, 6

4th note: 5, 6

5th note: 6

6th note: 2, 3, 4, 5, 6

7th note: 3, 4, 5, 6

8th note: 4, 5, 6

9th note: 5, 6

10th note: 6

11th note: 2, 3, 4, 5, 6

etc...

If **Repeat Times** is **1**, **Note-On Advance** will make the Wave Sequence play as follows:

1st note: 2, 3, 4, 5, 3, 4, 5, 6

2nd note: 3, 4, 5, 3, 4, 5, 6

3rd note: 4, 5, 3, 4, 5, 6

4th note: 5, 3, 4, 5, 6

5th note: 3, 4, 5, 6

6th note: 4, 5, 6

7th note: 5, 6

8th note: 6

9th note: 2, 3, 4, 5, 3, 4, 5, 6

10th note: 3, 4, 5, 3, 4, 5, 6

11th note: 4, 5, 3, 4, 5, 6

12th note: 5, 3, 4, 5, 6

13th note: 3, 4, 5, 6

14th note: 4, 5, 6

15th note: 5, 6

etc...

Finally, if **Repeat Times** is **INF**, **Note-On Advance** will make the Wave Sequence play as follows. Note that the Wave Sequence never returns to the start step, since it's outside of the loop:

1st note: 2, 3, 4, 5, 3, 4, 5, 3, 4, 5, 3, 4, 5...

2nd note: 3, 4, 5, 3, 4, 5, 3, 4, 5, 3, 4, 5...

3rd note: 4, 5, 3, 4, 5, 3, 4, 5, 3, 4, 5...

4th note: 5, 3, 4, 5, 3, 4, 5, 3, 4, 5...

5th note: 3, 4, 5, 3, 4, 5, 3, 4, 5...

6th note: 4, 5, 3, 4, 5, 3, 4, 5...

7th note: 5, 3, 4, 5, 3, 4, 5...

8th note: 3, 4, 5, 3, 4, 5...

9th note: 4, 5, 3, 4, 5, 3, 4, 5...

10th note: 5, 3, 4, 5, 3, 4, 5...

etc...

### Note-On Advance and Key Sync

**Note-On Advance** is also affected by the setting of the **Key Sync** parameter.

If **Key Sync** is **On**, the start point will advance by one step for each note.

If **Key Sync** is **Off**, the start point will advance by one step for each new phrase. For more information, see "Key Sync" on page 789 of the Parameter Guide.

## Saving Wave Sequences

Once you've spent all this time editing, you'll want to save your work. To save your Wave Sequence edits:

### 1. Select the Write Wave Sequence command from the page menu.

This brings up a dialog box which allows you to save the Wave Sequence. Optionally, you can also select a new location, or change the Wave Sequence's name.

### 2. Press the "T" button to bring up the text edit dialog.

You can give the Wave Sequence a descriptive name using the on-screen keyboard.

### 3. After entering the name, press OK.

The text edit window will disappear, returning you to the main Save dialog.

### 4. Press the popup button next to WaveSeq to bring up the save location dialog.

### 5. Select a location to save the edited Wave Sequence.

To avoid overwriting the factory sounds, it's safer to use a slot in one of the User banks.

### 6. After selecting the location, press OK.

### 7. Press OK again to start the write process.

### 8. If you're sure you want to write to this location, press OK again.

After that, you're done!

 Do not turn off the power for at least 10 seconds after writing the Wave Sequence data. This allows the system time to complete the process, which includes saving a backup of the data to the internal disk.

 The Wave Sequence **Tempo**, **Key Sync**, **Swing**, and **Quantize Trigger** settings are stored with each Program, Combination, or Song. These parameters are provided on the Wave Sequence pages for use during editing, but are not actually saved with the Wave Sequence. If you've moved from Program or Combination mode and edited these parameters, return to the previous mode and write your edits.

## Using Drum Kits

### Drum Kit Overview

#### What's a Drum Kit?

Drum Kits, as the name implies, are optimized for creating drum sounds. They offer a number of special features, such as:

- Each note can play a different sound
- Instead of selecting Multisamples (which span the entire keyboard), you can select Drumsamples (which contain a single drum sound). These can be from the ROM, RAM, or EXs banks.
- On each note, you can use up to eight Drumsamples, with velocity crossfades
- Each note has separate settings for the most important sound parameters, including volume, filter cutoff and resonance, envelope attack and decay, pitch, drive and low boost, and gain for each band of the Program EQ. For instance, you could combine high drive and low cutoff frequency to create a lo-fi effect on only a few sounds, while the rest of the sounds remained clear and pristine.
- Each note can be routed to different Insert Effects, or have separate FX Send amounts. For instance, you can send a snare sound through a dedicated compressor.

You can use Drum Kits only in Programs whose **Oscillator Mode** is set to **Single** or **Double Drums**.

#### Drum Kit memory structure

The KRONOS has over 270 Drum Kits, divided into Internal, User, and GM (General MIDI) groups as shown below. You can edit or write into any of the locations except for the GM bank, which cannot be erased.

For details on the factory-programmed Drum Kits, please see the Voice Name List.

#### Drum Kit bank contents

Bank	Contents
INT-00...39, USER-A00...USER-C05	Factory Drum Kits
GM 0...8	GM2 Drum Kits
USER-C06...USER-G15 USER-AA00...USER-GG15	User Drum Kits

The 9 Drum Kits in the GM bank are compatible with the GM2 sound map. The other Drum Kits may use different mappings, where appropriate.

### Drum Kit Programs and Oscillator Mode

The Program's **Oscillator Mode** setting, on the Program Basic tab of the Basic/Vector page, sets whether the Program is used to play Drum Kits or to play normal Multisamples (such as pianos, strings, etc.).

You'll see the results of this setting on the OSC1/Basic tab of the OSC/Pitch page. If the **Oscillator Mode** is set to **Single** or **Double**, you can select up to eight Multisamples for each Oscillator, with velocity switches or crossfades.

If the **Oscillator Mode** is set to **Single Drums** or **Double Drums**, you'll be able to select a one or two Drum Kits. There are still eight levels of velocity switches and layers - but these are within the Drum Kit itself, and not stored or edited in the Program.

## Before you start editing...

### First, select a Drum Program

Drum Kits are edited in Global Mode. While you're in Global Mode, you'll play the kit that you're editing as if you were playing it from within the Program, Combi, or Song which was selected before you entered Global mode.

So, before you enter Global mode, it's best to select a Program which is already set up for drums, with the appropriate EG settings, effects, and so on. Just use the Program Category select popup, and choose a drum Program such as "Studio Standard Kit."

### Working with Double Drum Programs

If you select a Double Drums Program before entering Global mode, the Drum Kit from Oscillator 1 will be selected and ready for editing. When editing in Global mode, the selected Drum Kit will always play as if it were in the Program's Oscillator 1.

The Drum Kit in Oscillator 2 will continue to sound as well, although you can't edit it directly. You can control the volume balance between the two kits using the control surface, without leaving Global mode. To do so:

1. **Press the CONTROL ASSIGN [TIMBRE/TRACK] button.**

The Control Surface will then control the volumes of the two Oscillators.

2. **Use the MIX VOLUMES [1]--[2] sliders to adjust the volumes of the drum kits.**

### OSC1/Basic Octave setting

In order for the note mappings to match the keyboard, the Oscillator's **Octave** setting needs to be +0 [8']. All Drum Kit Programs should have this setting already. If you're unsure, you can check this yourself:

1. **Go to the OSC1/Basic tab of the OSC/Pitch page.**
2. **Check that the Octave parameter (near the top of the page) is set to +0 [8'].**

With a setting other than +0 [8'], the relationship between the keys and the Drum Kit sound map will be incorrect.

### Make sure that Memory Protect is disabled

Before you start editing, go to the Global Basic page, and look in the Memory Protect section. Make sure that **Drum Kit** is not checked—if so, you won't be able to make any edits.

## Editing Drum Kits

### Basic Editing

#### 1. Select the Program that you wish to use while editing the Drum Kit.

For more information, see “First, select a Drum Program,” above.

#### 2. Press the front-panel GLOBAL button to enter Global mode.

#### 3. Go to the Sample Setup tab of the Drum Kit page.

#### 4. Use the Drum Kit parameter, at the top of the screen, to select the Drum Kit that you wish to edit.

You can save this to a different memory location after editing, if you like.

#### 5. Use the Key parameter to select the note that you wish to edit.

To select a key, you can use any of the standard VALUE controllers (the slider, dial, numeric keypad etc.). As a shortcut, you can also hold down the ENTER key and play a note on the keyboard.

This Key selection applies to all three Drum Kit editing tabs.

#### 6. Use the Assign check box to specify whether the key will have its own settings, or use the same settings as the next higher note.

If **Assign** is **checked**, the key will have its own settings. This is the default.

If **Assign** is **not checked**, the key won't have its own settings. Instead, it will use the same settings as the next higher note—except that the Drumsamples will be played at a lower pitch. The amount of pitch change depends on the **Pitch Slope** parameter, on the **OSC1 Pitch** tab of the **OSC/Pitch** page.

Use this setting when you want only to change the pitch, such as with tom or cymbal sounds.

### Creating a velocity crossfade

For this key, let's create a simple velocity crossfade between two stereo Drumsamples.

#### 1. On the left side of the screen, make sure that DS1 and DS2 are turned On.

Just press the On/Off buttons to toggle them, if necessary.

#### 2. Similarly, make sure that DS3...8 are turned Off.

When they are turned off, most of their parameters will be grayed out.

#### 3. Select ROM Stereo as the Bank for DS1 and DS2.

### Drum Kits may be used by more than one Program

When you edit a Drum Kit, all Programs that use that Drum Kit will be affected. To avoid changing the factory voicing, you may wish to copy Drum Kits to empty locations in the USER banks before editing.

There are three main types of Drumsample Banks: **ROM**, **Smp**, and **EXs**. For each type, you can also choose between looking at mono and stereo Drumsamples. Note that stereo Drumsamples will require twice as many voices as mono Drumsamples.

**ROM** Drumsamples are the built-in “factory” sounds, and are always available. These are organized by category, such as bass drums, snares, hats, etc.

**Smp** Drumsamples include Akai, SoundFont 2.0, AIFF or WAV files loaded from disk, and samples created in Sampling mode.

**EXs** Drumsample banks are PCM expansion sets created especially for the KRONOS. Each has its own unique number; for instance, the ROM Expansion is EXs1, and the Concert Grand Piano expansion is EXs2. Only the currently loaded EXs banks will appear on this menu.

#### 4. Press the Drumsample popup for DS1.

This brings up a list of Drumsamples, organized by category. Use the tabs at the left of the screen to browse through the different categories.

For a list of the Drumsample names, please see the Voice Name List.

#### 5. Select a Drumsample by touching its name in the list.

#### 6. Press the OK button to confirm your selection.

#### 7. Do the same for DS2.

Now that you've assigned Drumsamples to DS1 and DS2, let's set up the velocity ranges and crossfades.

#### 8. Set DS2's Bottom Velocity to 001, and its Xfade Range to Off.

#### 9. Set DS1's Bottom Velocity to 80.

Now, DS2 will sound when you play softly, at velocities of 79 or less—and DS1 will sound when you play harder, with velocities of 80 or more.

You can also see this split visually, in the graphic on the right side of the LCD.

#### 10. Next, set DS1's Xfade Range to 20, and its Curve to Linear.

Notice that the graphic now shows the two ranges tapering into one another. Between 80 and 100, DS2 will fade out, and DS1 will fade in, creating a gradual velocity transition instead of a hard split.



---

### Fine-tuning the sound of each sample

#### 1. If you like, adjust the Levels for the two Drumsamples.

This can be very useful in creating a smooth velocity split or crossfade.

#### 2. Set the tuning and EG parameters as desired.

For each Drumsample, you can control offsets to the Program's settings for transposition, tuning, and EG attack and decay times.

#### 3. Go to the Sample Parameter tab.

This page lets you make even more adjustments to the sound. For each Drumsample, can control offsets to the Program's settings for filter cutoff and resonance, drive, and low boost. Additionally, you can control the gain for each band of the EQ.

For more information, please see "Global P5: Drum Kit" on page 796 of the Parameter Guide.

#### 4. Repeat steps 1–3 to set up each key of the Drum Kit.

You can also copy settings from one key to another, using the Copy Key Setup menu command.

---

### Using Exclusive Groups

#### 1. Select the Voice/Mixer tab.

#### 2. Use the Exclusive Groups to make one drum sound cut off another drum sound - such as closed and open hi-hats.

For example, let's say that you've assigned an open hi-hat and a closed hi-hat to the same exclusive group:

- Play the open hi-hat sound.
- While it's still ringing, play the closed hi-hat.
- The open hi-hat sound will be cut off—simulating the action of a physical hi-hat.

---

### Using Hold

The Program **Hold** parameter can be especially useful for drum programs, since it lets the samples ring out naturally regardless of how long you hold down the note. The way that this works depends on settings in both the Program and the Drum Kit, as described below.

To enable **Hold**:

#### 1. In Program mode, go to the Program Basic tab of the Basic/Vector page.

#### 2. Under Key Zone, make sure that the Hold check-box is checked.

Once you've turned on **Hold** for the Program, the function is controlled on a note-by-note basis according to settings within the Drum Kit.

#### 3. In Global mode, go to the Voice Mixer tab of the Drum Kit page.

#### 4. For each key, set the Enable Note Off Receive parameter as desired.

If this parameter is *unchecked*, the key will be held.

If it is checked, the key will not be held.

If you turn off **Hold** in the Program, no keys will be held - regardless of their **Enable Note Off Receive** setting.

---

### Controlling effects for each key

Drum Kits have their own, built-in mixers. For each key, you can control the Insert Effects bussing, Master Effects sends, and pan.

To use separate bus settings for each key:

#### 1. In Program mode, go to the Routing tab of the IFX page.

#### 2. Make sure that the Use DKit Setting check-box is checked.

When **Use DKit Setting** is on, the Program will use the Bus Select and Effects Send settings for each key of the Drum Kit.

When **Use DKit Setting** is off, the Program will ignore the Drum Kit's Bus Select and Effects Send settings.

#### 3. In Global mode, go to the Voice Mixer tab of the Drum Kit page.

#### 4. Use the Bus Select (IFX/Indiv. Out Assign) parameter to send drum sounds through their own Insert effects, or to the individual outputs.

If you like, you can send each note to its own Insert effect, or to the individual audio outputs, in addition to the main L/R outputs.

For example, you might send all snare sounds to **IFX1**, all kick sounds to **IFX2**, and the remaining sounds to L/R.

#### 5. Use "Send1(MFX1)" and "Send2(MFX2)" to set the send levels to the master effects.

---

### Controlling pan for each key

To use separate pan settings for each key:

#### 1. In Program mode, go to the Amp1/Driver1 tab of the Amp/EQ page.

#### 2. Under Pan, make sure that the Use DKit Setting check-box is checked.

When **Use DKit Setting** is on, the Program will use the pan settings for each key of the Drum Kit.

#### 3. In Global mode, go to the Voice Mixer tab of the Drum Kit page.

#### 4. Use the Pan parameter to specify the key's stereo output position.

---

### Double Drum Programs

Double Drum Programs let you layer two Drum Kits together. Most often, these will be close-mic'd and ambient versions of the same acoustic drums, so that you can control the balance between the two. You could also use this for creative layering and special effects, of course!

Everything else about Double Drum Programs is the same as for Single Drum Programs.

---

## Saving Drum Kits

Once you've spent all this time editing, you'll want to save your work. To save your Drum Kit edits:

**1. Select the Write Drum Kit command from the page menu.**

This brings up a dialog box which allows you to save the Drum Kit. Optionally, you can also select a new location, or change the Drum Kit's name.

**2. Press the "T" button to bring up the text edit dialog.**

You can give the Drum Kit a descriptive name using the on-screen keyboard.

**3. After entering the name, press OK.**

The text edit window will disappear, returning you to the main Save dialog.

**4. Press the popup button next to Drum Kit to bring up the save location dialog.**

**5. Select a location to save the edited Drum Kit.**

To avoid overwriting the factory sounds, it's safer to use a slot in one of the seven USER banks.

Note that although you can edit General MIDI kits, you can only save these edits to locations in the INT or USER banks. The original GM kits cannot be over-written.

**6. After selecting the location, press OK.**

**7. Press OK again to start the write process.**

**8. If you're sure you want to write to this location, press OK again.**

After that, you're done!

-  Do not turn off the power for at least 10 seconds after writing the Drum Kit data. This allows the system time to complete the process, which includes saving a backup of the data to the internal disk.



# Loading & saving data, and creating CDs

## Saving data

### Overview

There are three ways to save data; you can write it into internal memory, save it to disk (on the internal disk or external USB storage media, including CD-R/RW), or transmit it as a MIDI data dump. You can also use WAVE files to create an audio CD that can be played by CD players.

### Writing to internal memory

The following types of data can be written into the internal memory.

- **Programs**  
Programs 000–127 in banks INT–A...F, USER–A...G and AA...GG
- **Combinations**  
Combinations 000–127 in banks INT–A...G, USER–A...G
- **Global settings**  
(Global P0: Basic–P3: Category Name)
- **User Wave Sequences**  
Banks INT: 000...149, Banks USER–A...GG: 00...31
- **User Drum Kits**  
Banks INT: 00...39, Banks USER–A...GG: 00...15
- **User Drum Track Patterns**  
User 000...999
- **FX Presets**  
Preset 00...15 and User 00...15 for each effect
- **User Template Songs**  
User 0...15. These include the program selections, track parameters, effect settings, KARMA settings, and the name and tempo of the current song as a re-usable template. For more information, see “Save Template Song” on page 628 of the Parameter Guide.

### Sample data must be saved to disk

 Sampling Mode Multisamples and Samples must be saved to and loaded from disk; they cannot be written into internal memory.

This means that if you turn the power off and then on once again, but do not re-load the necessary Multisamples or Samples into Sampling Mode, any data that uses those Multisamples or Samples will not sound as intended. This can include Combinations, Programs, Drum Kits, Wave Sequences, and Multisamples.

Once they’ve been saved to disk, you can set the KRONOS to automatically load them at startup. For details, see “Automatically loading sample data” on page 174.

### Songs must be saved to disk

As with Sampling Mode data, Songs must be saved to disk; they cannot be saved in internal memory.

### Saving to disk, CDs, and USB media

The following file types can be saved to disk:

- **.PCG files**  
Set Lists, Programs, Combinations, global settings, Drum Kits, User Drum Track Patterns, and Wave Sequences. (You can choose which data types are included, via options in the Save dialog.)
- **.SNG files**  
Song and region data.
- **.KMP files**  
These are Korg format Multisamples.
- **.KSF files**  
These are Korg format Samples.
- **.KSC files**  
These store collections of EXs Multisamples and Drumsamples, and/or User Multisamples and Samples.
- **.KFX files**  
Effect preset data.
- **.KGE files**  
KARMA GE data.
- **.MID files**  
Saves a Sequencer mode song in Standard MIDI File (SMF) format.
- **.EXL files**  
System exclusive data from an external device that was saved on the KRONOS. (This allows the KRONOS to be used as a data filer.)
- **.WAV and .AIF files:**  
User samples can be exported as WAVE or AIFF files.
- **.KCD files:**  
These are track lists for audio CDs.

### MIDI data dump

The following types of data can be transmitted as a MIDI data dump and saved on an external data filer or other device.

- Set Lists, Programs, Combinations, global settings, Drum Kits, Drum Track Patterns, and Wave Sequences
- Songs

For more information, see “Dump Program” on page 808 of the Parameter Guide.

### About preload data and preset data

“Preload data” refers to the sounds and other data loaded in the KRONOS when it is shipped from the factory. You are free to rewrite this data, and with the exception of the demo songs, the data will be written to the location listed in

“Writing to internal memory.” All of this data is stored in the internal disk, and backups are provided on the included Accessory Discs.

- Programs INT–A...F, USER–A...F, and USER–AA...BB
- Combinations INT–A...D
- Drum Kits INT: 00–39, A00...B15, and C00...05
- Wave Sequences INT: 000...148, USER–A00...24, and USER–F 00...12

- Demo songs

Preset data is data that cannot be rewritten by the Write operation. This includes the following data:

- The General MIDI Program banks, including G, g(1)–g(9), and g(d): 001–128
- Preset Drum Kits 144 (GM)–152 (GM)
- Preset Template Songs P00–P17
- Preset patterns P000–P718

## Writing to internal memory

### Writing Programs and Combinations

Edits to Programs and Combinations can be saved to the internal memory, which we’ll refer to as “Writing.” If you want edits to be preserved after the power is turned off, you must write them.

There are two ways to write Programs and Combinations, as described below: using the Write menu commands, and using the SEQUENCER REC/WRITE button.

- ⚠ Do not turn off the power for at least 10 seconds after using any of the **Write** commands. This allows the system time to complete the process, which includes saving a backup of the data to the internal disk.
- ⚠ Before you write data into memory, you must turn off the related memory protect setting(s) in Global mode. (See “Memory protect” on page 195.)
- ⚠ Combinations rely on Programs to make sounds, but they don’t contain the actual Program parameters. Instead, they simply remember the Program banks and numbers. If you edit a Program that’s used by a Combination, or load a different Program into the same bank and number, the sound of the Combination will also change.

### Using the Write commands

1. Anywhere in Program or Combination modes, select the page menu command “Write Program” or “Write Combination.”

The Write Program or Write Combination dialog box will appear.

*Note:* You can also reach the same dialog box by holding down the ENTER button and pressing 0 on the numeric keypad. (See “Shortcuts” on page 6.)

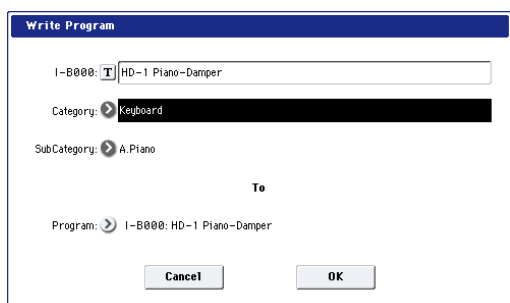

The screen shown is for Program mode

2. Check the program/combination name displayed in the upper line (the writing source).
3. If you wish to change the name of the program/combination, press the text edit button.

The text dialog box will appear. Enter the name of the program/combination. See “Editing names and entering text” on page 193.

After you have entered the name, press the OK button to return to the Write Program/Write Combination dialog box.

4. In “Category,” specify the category of the Program/Combination.

5. Select a Sub Category as well.

Both Combinations and Programs can be selected by Category, in addition to bank and number. For more information about Categories and Programs, see “Selecting by Category” on page 33; for similar information about Combinations, see “Selecting by Category” on page 64.

You can also select Programs by Category from within Combinations and Songs. For more information, see “Selecting Programs for Combi Tracks” on page 66.

6. Use “To” to specify the bank and number of the writing destination program/combination.

Use the VALUE controllers or the BANK switches to make your selection.

7. To execute the Write operation, press the OK button. To cancel without executing press the Cancel button.

When you press the OK button, the display will ask “Are you sure?” When you press the OK button once again, the data will be written.

### Using the SEQUENCER REC/WRITE button

In Program and Combination modes, pressing the SEQUENCER REC/WRITE button opens the Update dialog box.

This is a shortcut method which saves changes to the current bank/number location, overwriting the old version of the Program or Combination. (If you want to save changes to a different bank and/or number, use the Write menu command instead.)

To update a Program or Combination:

1. Press the SEQUENCER REC/WRITE button.

The Update Program/Update Combination dialog box will appear.

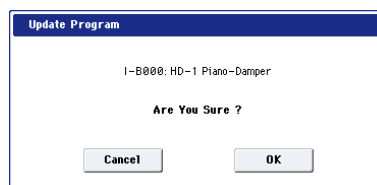

2. To write the data, press the OK button. To cancel without writing, press the Cancel button.

### Saving Tone Adjust edits

Tone Adjust edits are saved in different ways depending on whether the parameter is **Relative** or **Absolute**, and whether you're saving a Program, Combination, or Song.

- **Relative** parameters typically adjust two or more Program parameters simultaneously. For instance, **Filter/Amp EG Attack Time** affects a total of six Program parameters. The value of the Relative parameter shows the amount of change to these underlying Program parameters.
- **Absolute** parameters usually control a single Program parameter, such as **Oscillator 1 Transpose**. The Program and Tone Adjust parameters mirror one another; when you change one, the other will change to match.

Program mode:

- Edits to **Relative** parameters affect the sound immediately, but don't change the underlying Program parameter settings until the Program is saved. When the Program is saved, the KRONOS calculates the combined effects of Tone Adjust and dedicated CC modulation (from the Real Time Knobs, for instance), and saves the results into the Program parameters directly. At that point, all of the Relative parameters are reset to 0.
- Edits to **Absolute** parameters are immediately reflected in the corresponding on-screen parameters, and vice-versa.

Combination and Sequencer modes:

- Edits to both **Relative** and **Absolute** parameters are written and preserved as the Tone Adjust settings for the Timbre or Track.

## Writing Drum Kits and Wave Sequences

For details on how to write Wave Sequence edits to memory, see "Saving Wave Sequences" on page 185.

For details on how to write Drum Kit edits to memory, see "Saving Drum Kits" on page 189.

## The Edit Buffer, Write, and Compare

"Edit buffers" are temporary areas in memory used for storing edits. There are five separate edit buffers, one for each of the following data types:

- Set Lists
- Programs
- Combinations
- Wave Sequences
- Drum Kits

Each time you select one of these items—a Set List, Program, etc.—it's copied into the data type's edit buffer. When you make edits, the changes are applied to version in the edit buffer, and not to the stored version.

Using the menu command **Write** copies the edit buffer back to the stored version, making the edits permanent.

Note that there is only one edit buffer for each data type. For instance, if you start to edit Program INT-A000, and then change to Program USER-G127, the edits to INT-A000 will be lost.

Changing to a different data type does not clear the edit buffer, however. For instance, you can edit a Program, switch to Combi mode to hear how the Program sounds in a Combination, and then switch back to Program mode without losing your edits to either the Program or the Combination.

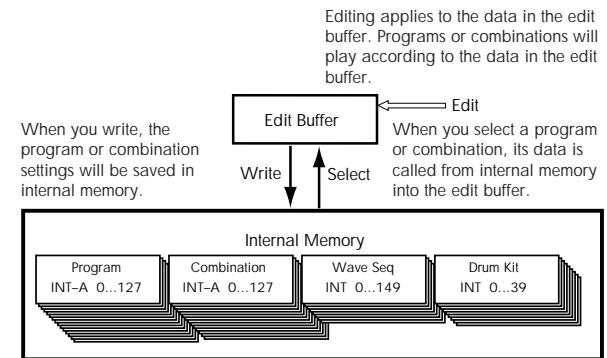

## Compare

The COMPARE button lets you go back and forth between the stored version of the sound and the version in the edit buffer. The LED on the COMPARE button lets you know which version you're listening to. For instance:

1. Select a Combination.
2. Change Timbre 1 to play a different Program.
3. Press the COMPARE button.

The COMPARE LED lights up, and Timbre 1 returns to the original Program.

4. Press the COMPARE button again.

The COMPARE LED turns off, and Timbre 1 switches back the new Program.

Compare operates on the type of data you're currently working with. For instance, when you're in Set List mode, it acts on the Set List; when you're in the Wave Sequence edit pages on Global P4, it acts on the Wave Sequence.

## Editing names and entering text

You can change the names of any user-editable data, including Set Lists, Programs, Combinations, Songs, Samples, disk files and directories, and more (see "Where can names be changed?" on page 194). You can also change the names of all Categories and Sub Categories.

For entering text you can use either the on-screen keyboard or a connected USB alphanumeric keyboard, as described below.

### Using the on-screen keyboard

Here's how to change the name of a Program to "Piano 01" using the Write page menu command and the on-screen keyboard:

1. Press the text edit button **T** to open the text edit dialog box. (See the graphic "Text edit dialog," below.)
2. Press the Clear button to delete the previous name.
3. Press the Shift button to switch to uppercase characters, and press the character P.

4. Press the Shift button again to switch to lowercase characters, and press the characters i, a, n, o.

The text will now read “Piano.”

5. Press the Space button to enter a space, and then press the characters 0, 1.

The text will now read “Piano 01.”

6. Press the OK button to close the dialog box.

If you don’t need to make any corrections, press the OK button again to complete the Write command. The edited name will be saved.

**Using a USB alphanumeric keyboard**

Anywhere that you can enter text, you can use a connected USB alphanumeric keyboard as an alternative to the touch-screen keyboard. A keyboard with the standard US “IBM PC” QWERTY layout is recommended.

Note that some characters may not be supported. Also, some names—such as files and directories on the disk—may support more limited character sets than internal names. The on-screen keyboards adapt to show only the characters allowed for the current application, and only those characters are available via USB.

In addition to text entry, you can also move the cursor using the left and right arrow keys, and delete text using the Delete key.

In the Find dialog, Return is the same as pressing the on-screen Find button.

When editing Set List Slot comments, additional keyboard commands are supported:

- Home moves the cursor to the beginning of the first line
- End moves the cursor to the end of the current text
- The up and down arrows, and page up and down, move between lines of text
- Return and Enter create line-breaks

*Text edit dialog*

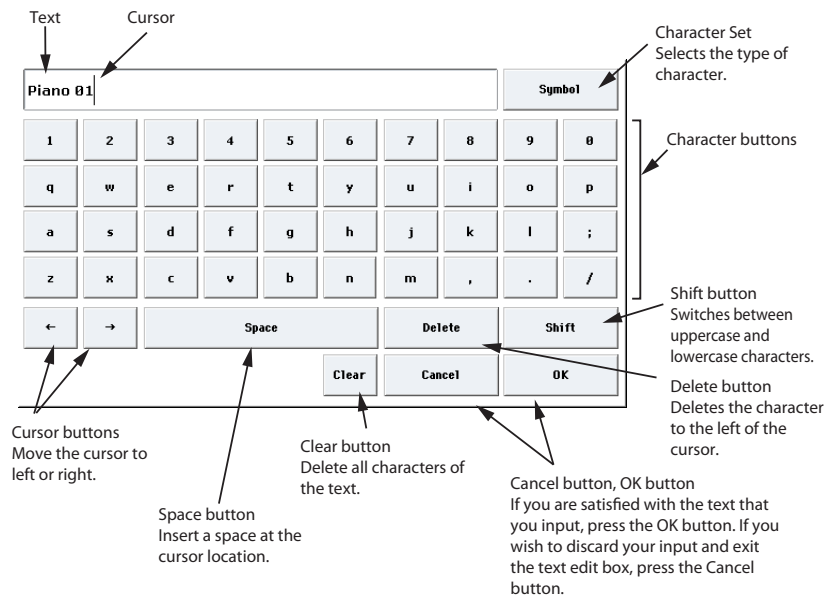

**Where can names be changed?**

Names can be changed on the following pages.

Set Lists	Set List P0...9 page menu command: Write Set List
Set List Slots	Set List P1: Slot Name parameter
Programs	Program P0...9 page menu command: Write Program
Combinations	Combination P0...9 page menu command: Write Combination
Wave Sequences	Global P4 page menu command: Write Wave Sequence
Drum Kits	Global P5 page menu command: Write Drum Kit
Effect Presets	Program, Combination, Sequencer, and Sampling modes P8 & P9 page menu command: Write FX Preset
Songs	Sequencer P0, 1, 2, 3 page menu command: Rename Song

Regions	P4: Track Edit– Edit Region
Tracks	Sequencer P4: Track Name
Patterns	Sequencer P5: Pattern Name
Sampling Mode Multisamples	Sampling P0...4 page menu command: Rename MS
Sampling Mode Samples	Sampling P0...4 page menu command: Rename Sample
Categories & sub categories	Global P3: Program, Combination, and KARMA Category tabs
Files	Disk Save: Save All...Save Audio CD Track List, Disk Utility page menu command: Rename
Directories	Disk Utility page menu commands: Create Directory & Rename
Disk volumes	Disk Utility page menu command: Format



## Memory protect

Memory Protect lets you prevent certain types of data from being overwritten accidentally. There are individual check-boxes to enable Memory Protect for different parts of the system, as described below.

For Programs, Combinations, Songs, Set Lists, Drum Kits, Wave Sequences, and KARMA GEs, Memory Protect prevents:

- Using the Write command to save edits
- Loading the data type from disk
- Receiving dumps of the data type via MIDI SysEx

When enabled for Songs, Memory Protect also prevents recording in Sequencer mode.

When enabled for Internal HDD Save, Memory Protect prevents saving any data to the internal disk.

Before saving edits, loading data, and so on, use the following procedure to turn the memory protect off.

1. Press the GLOBAL switch to enter Global mode.
2. Go to the Global P0: Basic Setup– Basic page, and select the Basic page.

Press the Basic tab at the bottom, and then press the Basic tab above it.

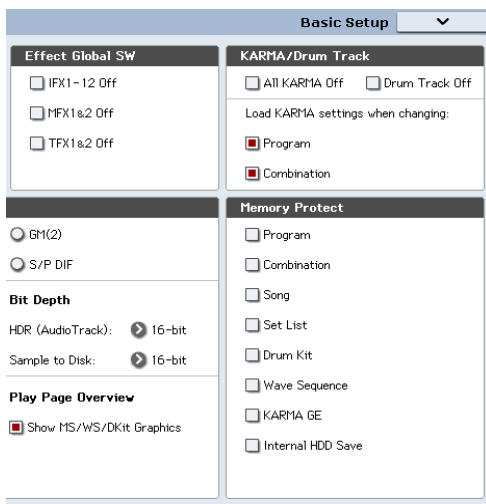

3. Press the “Memory Protect” check box for each type of data you wish to write or save, so that the box is unchecked.

## Writing Global settings

Any edits in Global pages P0–P3 are temporary until you use the Write command to store them in the internal memory. If you don’t use the Write command, your changes will be gone when you turn off the power.

(Note that Wave Sequences and Drum Kits are stored separately from the other Global parameters.)

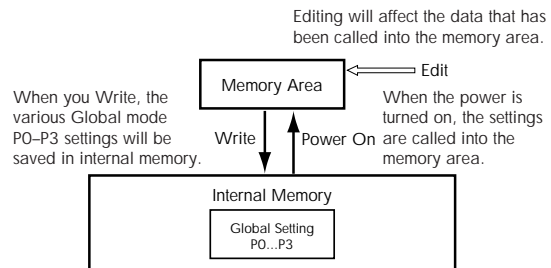

There are two ways to write global settings.

### Using the Write page menu command

1. To write global settings (the various settings in Global P0–P3), press the page menu command Write Global Setting in Global P0–P3.

The Write Global Setting dialog box will appear.

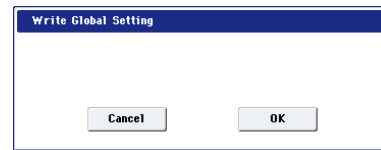

*Note:* The same dialog box will also appear if, in each of the above pages, you hold down the ENTER switch and press the 0 switch. (See “Shortcuts” on page 6)

2. To execute the Write operation, press the OK button. To cancel, press the Cancel button.

When you press the OK button, the display will ask “Are you sure?” Press the OK button once again to write the data.

### Using the (SEQUENCER) REC/WRITE switch to write

1. In the Global P0–P3 pages, press the SEQUENCER REC/WRITE switch.

A dialog box will appear.

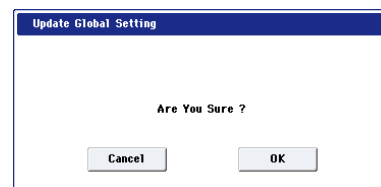

2. To execute the Write operation, press the OK button. To cancel, press the Cancel button.

 Do not turn off the power for at least 10 seconds after writing the Global data. This allows the system time to complete the process, which includes saving a backup of the data to the internal disk.

## Saving to disks, CDs, and USB media

### Some types of data must be saved to disk

Everything that you create or edit within the KRONOS—sounds, songs, samples, etc.—can be saved to disk, and backed up on external media.

As described under “Writing to internal memory” on page 192, some types of data can be written into internal memory, without using the Disk mode Save commands.

Other types of data must be saved to disk before the power is turned off, or any changes will be lost. This includes Song and region data from Sequencer mode, as well as Sampling Mode Multisamples and Samples. In order to keep this data, you must write it to the internal disk or to an external USB storage device (hard disks, flash media, CD-R/RW drive, etc.). When you’ve come up with settings you like, it’s a good idea to save them, so that you’ll always be able to reload them if desired.

- Do not turn off the power for at least 10 seconds after saving data. This allows the system time to complete the process, which may continue in the background even after the disk operation appears to be complete.

### Types of media you can use

#### Internal SSD

The internal disk is a 30 GB solid-state drive, providing fast, quiet operation and shock resistance.

#### USB storage media (hard drives, flash media, etc.)

The KRONOS supports MS-DOS FAT16 and FAT32 formatted USB storage devices, including hard disks, removable disks, and flash media.

##### Capacity recognized:

- FAT32: up to 2 terabytes = 2,000 Gigabytes (GB)
- FAT16: up to 4 GB

#### USB CD-R/RW and DVD drives

KRONOS supports three CD-R/RW formats: UDF, CD-DA (audio CDs) and ISO9660 (level 3).

Standard saving and loading from CD-R/RW drives uses the UDF format, which allows you to treat CDs much as you would a hard drive. For more information, see “CD-R/RW disks on the KRONOS: UDF and packet-writing” on page 1156 of the Parameter Guide.

You can load data from ISO9660 (level 3) discs, but KRONOS does not write directly to ISO9660 format. You can, however, convert a UDF-formatted CD-R/RW to ISO9660 format, for easier loading on other systems. For more information, see “Convert to ISO9660 Format” on page 854 of the Parameter Guide.

You can also load data from UDF-formatted DVD-ROMs.

Finally, you can sample audio from CD-DA (audio CD) discs, and can also record your own music to audio CDs. For more information, see “Sampling from an Audio CD” on page 153, and “Creating audio CDs” on page 206.

### USB Floppy disks

MS-DOS format 3.5 inch 2HD and 2DD floppy disks can be used. The formatted capacity of the floppy disks will be 1.44 MB (18 sectors/track) for 2HD, and 720 KB (9 sectors/track) for 2DD.

### Media setup

Before saving or loading data, make sure that the desired disk or USB storage media is selected.

#### Setup for saving data on the internal disk

- Press the DISK button to enter Disk mode.
- Use Drive Select to select HDD: INTERNAL HD.

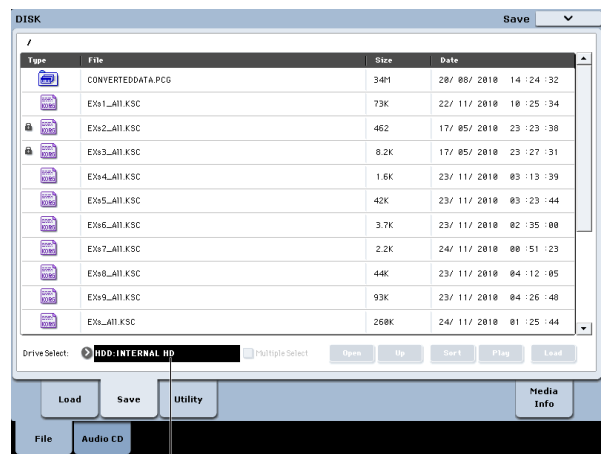

Drive Select

#### Setup for using a USB device

- Use a USB cable to connect the USB 2.0 connector of the KRONOS to the USB connector of your USB device (hard disk, removable disk, CD-R/RW).

*Note:* The KRONOS’s USB 2.0 connectors support hot-plugging; you can connect or disconnect the USB cable while the power is on. However in order to do so, your USB device must also support hot-plugging.

- Turn on the power.
- If you are using a USB hard disk, removable disk, or CD-R/RW drive, turn on the power of your USB device and use a USB cable to connect it to the KRONOS’s USB 2.0 connector.

*Note:* The above step assumes that your USB device supports hot-plugging. If you are using a device that does not support hot-plugging, connect it with the power turned off. After plugging it in, turn on the power.

- While the KRONOS is accessing the USB device, do not connect another USB device or disconnect the connected device. Doing so may damage your data.

- Press the DISK button to enter Disk mode.
- Wait a few seconds to allow USB devices to be recognized.
- Use Drive Select to select the desired device.

If you are using a removable disk, insert the media. After you exchange media in your USB device, press the LCD screen to make the KRONOS detect the media. When the media has been detected, the LCD screen will display information about the media.

**7. If the media needs to be formatted, execute the Format operation.**

Media requiring formatting is indicated as Unformatted in Drive Select. For more information, see “Formatting media” on page 198.

**Saving memory contents to disk**

You can save various types of data individually, as listed under “Saving to disk, CDs, and USB media” on page 191. However, you can also save all of the most important contents of memory at once, including:

- Set Lists, Programs, Combinations, Drum Kits, Wave Sequences, User Drum Track Patterns, and global settings
- Songs and recorded audio
- Sampling Mode Multisamples and Samples
- Links to loaded EXs and User Sample Bank data

 If you save this data to low-capacity media, you may need more than one disk.

To save all of the above data at once:

1. Prepare the media on which you want to save the data. (See “Media setup” on page 196.)
2. Press the front-panel DISK switch to enter Disk mode.
3. Select the Disk-Save page. Press the File tab, and then the Save tab.
4. Press Drive Select to select the save-destination drive.
5. If the media contains directories, select the directory in which you want to save the data.

Press the Open button to move to a lower level, or press the Up button to move to an upper level.

*Note:* If you are saving data on high-capacity media, we recommend that you create directories to organize the media into sections.

To create a new directory, move to the level at which you want to create the directory, and use the Utility page menu command **Create Directory**.

**6. Select the Save All command from the page menu.**

**Save All** will save the sounds, songs, and sample data, and KARMA GEs at the same time.

A dialog box will appear. The contents, settings, and operations for the dialog box will depend on the type of data that you are saving.

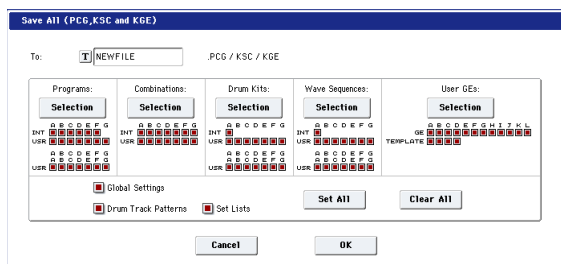

**7. Press the text edit button and enter a name for the files. (See “Editing names and entering text” on page 193.)**

All of the files created by **Save All** will share this name, but with different file extensions. If you load one of these files later, you’ll be given the option to automatically load all of the other related files as well—a handy time-saver.

**8. For now, leave all of the boxes checked in the Selection button dialogs.**

There are individual check-boxes for each bank of Programs and Combis, and for various other types of data. Leaving all of these checked ensures that you’re saving everything you’ll need.

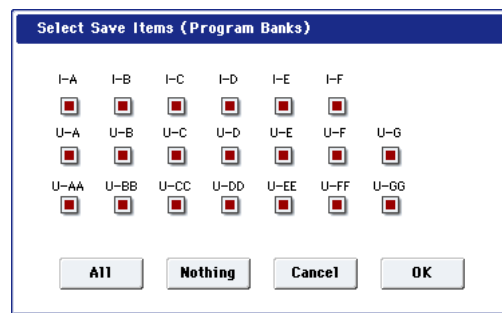

**9. Press the OK button to execute the Save operation.**

All of the data will be saved, creating a handful of different files. For details, see “File types included in Save All,” below.

When the save is complete, the system returns to the Save page, and the display will show the resulting file(s). The amount of time required will depend on the amount of data being saved.

If a file with the same name already exists on the media, you will be asked whether you want to overwrite. If you wish to overwrite, press the OK button. If you wish to save without overwriting, press the Cancel button, re-do the operation from step 6, and rename the data in step 7 before saving it.

**Split files**

If the data does not fit onto the selected volume, the “No space available on medium” dialog box will appear. You can press the OK button to divide the file will be divided and save it to multiple volumes of media (such as multiple USB sticks). If you don’t want to divide the file, press the Cancel button, and save the file to larger-capacity media.

For more information, see “Save All (PCG, SNG and KSC)” on page 845 of the Parameter Guide.

**File types included in Save All**

The various types of data are saved as the following files.

**.PCG file:** This contains all of the Programs, Combinations, Drum kits, Wave Sequences, and global settings from the internal memory.

**.SNG file:** This contains all of the Songs from Sequencer mode.

*Note:* If the audio tracks contain recorded data, region data will also be saved at this time. The WAVE files are stored in a directory named after the .SNG plus “\_A” at the end, in the same directory as the .SNG file itself.

**.KSC file:** This lists all of the Multisamples and Samples in Sampling Mode, along with all of the loaded EXs and User Sample Bank Multisamples and Drumsamples.

**Directory:** A directory containing the User Multisamples (.KMP files) and Samples (.KSF files) that are listed in the .KSC file.

### Data dependencies

When using **Save All**, “Save PCG & SNG,” and **Save PCG** to save Combinations, you should also remember to save the Programs used by each timbre (or the Drum Kits and Wave Sequences used by the Programs) at the same time.

Similarly when saving Programs, you should also remember to save the Drum Kits and Wave Sequences used by the programs.

*Note:* If your programs or drum kits use multisamples and samples that were created in on KRONOS, we recommend that you use **Save All** to save the data.

When you use **Save PCG** or **Save Sampling Data** to individually save a program or drum kit, or a multisample or sample that you created, we recommend that you save them under the same filename in the same directory. When you use “Load PCG” to load a .PCG file, the identically-named .KSC file will also be loaded so that the correct multisamples/samples will correspond automatically.

### Saving only a single bank of sounds

You can also choose to save only a single bank of sounds, or just a few banks, without saving any other data. To do so:

1. **Go to the Save page, and select the disk and directory into which you’d like to store the sounds.**

For details, see steps 1 through 5 under “Saving memory contents to disk” on page 197.

2. **Select the Save .PCG command from the page menu.**

The Save PCG Data dialog appears.

3. **Press each Selection button, and in the dialog box that appears, select only the banks that you’d like to save.**

Remember to save any dependent data! For instance, if Programs use Wave Sequences, you need to save the Wave Sequences as well. See “Data dependencies,” above.

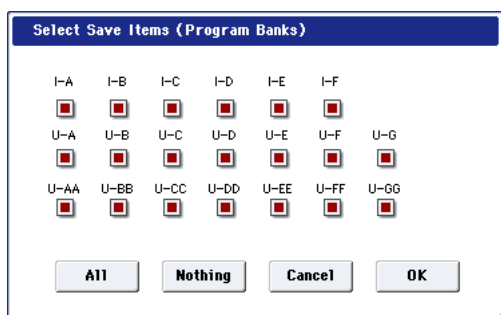

4. **Un-check the Global Setting and Set List check-boxes.**

If you’re saving just one or two banks of sounds, you don’t need to save these.

5. **If the sounds rely on user Drum Track patterns, leave Drum Track Pattern checked.**

6. **Press the text edit button and enter a name for the file. (See “Editing names and entering text” on page 193.)**

7. **Press OK to save the sounds.**

## Using the KRONOS as a data filer

The KRONOS can receive MIDI System Exclusive data sent by an external device, and save this data to media. (This is sometimes referred to as “Data Filer” functionality.) For more information, see “Save Exclusive” on page 850 of the Parameter Guide)

## Formatting media

Newly purchased media or media that has been used by another device may not be able to be used “as is.” In this case, you may need to format the media before you can use it with the KRONOS.

- The KRONOS is shipped with the internal disk already formatted.
- When creating audio CDs, you don’t need to format the CD-R/RW media.
- ⚠ When you format, all data saved on that media will be erased. If you had used a computer etc. to set up that drive so that it can be used as multiple drives (partitions), this data will also be erased. Be sure to double-check before you format.
- ⚠ After formatting, it is not possible to press the COMPARE switch to return to the previous state.

1. **Make sure that the media you want to format is inserted.**  
(See “Media setup” on page 196)
2. **Press the DISK button to enter Disk mode.**
3. **Select the Disk-Utility page. Press the File tab, and then the Utility tab.**
4. **Press Drive Select, and choose the drive that you want to format.**
5. **Press the page menu button to access the page menu, and press “Format” to open the dialog box.**

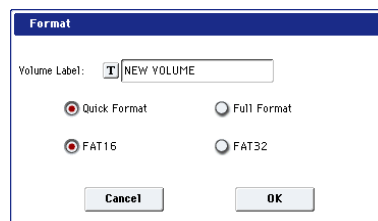

6. **In “Volume Label,” use the text edit button to access the text edit dialog box, and specify the volume label.**

The previously-specified volume label will be displayed. If no volume label had been specified for the media, or if a non-DOS media was inserted, this will indicate “NEW VOLUME.”

7. **Specify the initialization format.**

**Quick Format:** Normally you should use Quick Format to initialize the media.

Select this if the media has already been physically formatted, or if you want to format media that has been UDF-formatted by the KRONOS. Since only the system area of the media need be formatted, this will require less time.

*Note:* For the internal disk you can only select “Quick Format.”

**Full Format:** Select this when formatting media that has not been physically formatted, or media (CD-RW) that has not been UDF-formatted.

*Note:* Normally, it is not necessary to perform a Full Format on media that has been physically formatted at 512 bytes/block. Execute the Quick Format for such media.

*Note:* You will normally select Full Format for CD-RW media etc. that has not been UDF-formatted. If an error message of “Media not formatted” appears, execute Full Format.

Depending on the capacity of the media, executing Full Format may require a substantial length of time.

**8. Specify the file system.**

Use FAT16 to format media of 4 GB or less (such as flash media), and use FAT32 to format larger media (theoretically, up to 2 Terabytes).

**9. Press the OK button to format, or press the Cancel button if you decide to cancel.**

When you press the OK button, a message will ask you for confirmation. Press the OK button once again to execute the Format operation.

 You must format a CD-R/RW disc if you want to use it for packet writing, or if it has previously been used by another device.

You do not need to format a CD-R/RW disc that you will use to create an audio CD.

 You must use the KRONOS to format the media. The KRONOS will not correctly recognize media that has been formatted by another device.

## Loading data from disk

The types of data that can be loaded from media are shown in the diagram “Supported file types” on page 202. (For more details, see “Load selected” on page 828 of the Parameter Guide.)

The Disk mode Load page lets you load data from the internal disk or any USB 2.0 Mass Storage Device, such as hard drives, flash media, CD-R/RW drives, etc.

## Loading Songs, sounds, samples, and KARMA GEs together

As an example here, we’ll explain how to load a song which uses Programs that you’ve edited, Multisamples that you’ve created, and custom KARMA GEs. In such cases, it is best to load “all data.”

 When loading data, make sure that the Global mode memory protect setting is unchecked. For more information, see “Memory protect” on page 195.

1. **Make sure that the disk or USB storage media is ready for you to load data.** (See “Media setup” on page 196.)
2. **Press the DISK button to enter Disk mode.**
3. **Select the Disk–Load page. Press the File tab, and then the Load tab.**

Press **Drive Select** and select the media from which you want to load.

4. **Navigate to the directory that contains the file you want to load, and select the .SNG file.**

Press the **Open** button to move to a lower level, or press the **Up** button to move to a higher level.

The selected .SNG file will be highlighted.

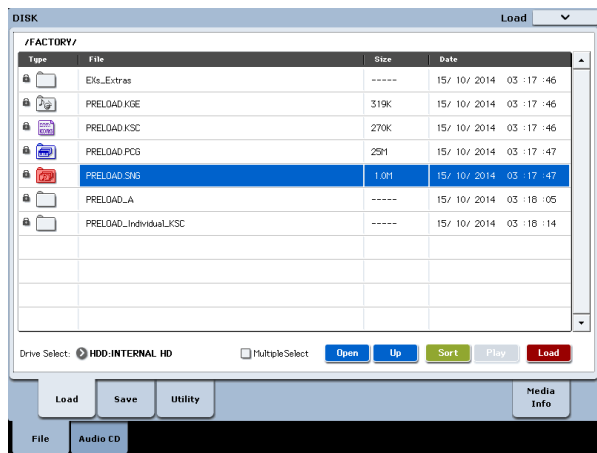

5. **Press the Load button.**

Alternatively, you can use the **Load Selected** command in the page menu.

A dialog box will appear.

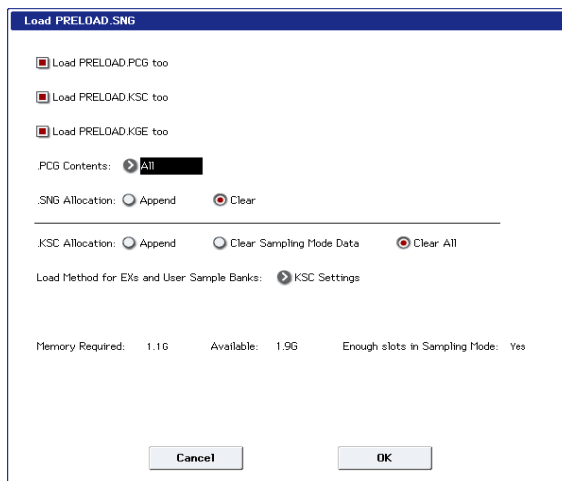

*Note:* The contents and settings of the dialog box will differ depending on the type of file that you are loading.

As described under “Saving memory contents to disk” on page 197, the KRONOS assumes that if .SNG, .PCG, .KSC, and .KGE files share the same name, they’re associated with one another. The next few options let you load these similarly-named files, if they exist.

6. **Check the “Load \*\*\*\*\*.PCG too” check box.**

This loads the Programs, Wave Sequences, Drum Kits, etc. along with the .SNG file.

7. **Use “.PCG Contents” to specify the data that you want to load from the .PCG file.**

You can load only a single bank, if you like. For this example, we want to all the data in the .PCG file, so we’ll select All.

8. **Check the “Load \*\*\*\*\*.KGE too” check box.**

This loads the user KARMA GEs along with the .SNG file.

9. **Check the “Load \*\*\*\*\*.KSC too” check box.**

This loads the Multisamples, Samples, etc. along with the .SNG file.

10. **Use “.SNG Allocation” to specify whether or not to erase any Songs currently in memory.**

**Append** will load the song into the song number that follows the song(s) currently existing in internal memory, without leaving a vacant number.

**Clear** will erase all songs from internal memory, and load the songs into the numbers from which they were saved.

11. **Use “.KSC Allocation” to specify whether or not to erase any samples currently in memory.**

**Append** will leave all currently-loaded Sampling Mode, EXs, and User Sample Bank data intact. Sampling Mode Multisamples and Samples will be loaded into the next available vacant numbers following the existing data.



**Clear Sampling Mode Data** will erase all Multisamples and Samples from Sampling Mode, and load the data in the same configuration with which it was saved. Existing EXs and User Sample Bank data is left intact.

**Clear All** is similar to **Clear Sampling Mode Data**, above, but also un-loads existing EXs and User Sample Bank data before loading the new .KSC file. This frees up the most memory for the new .KSC.

You can use the information at the bottom of the dialog box, including **Memory Required**, **(Memory) Available**, and **Enough slots for Samples & MS**, to determine whether or not you need to free up room for the new .KSC.

### 12. Set the Load Method for EXs and User Sample Banks as desired.

This sets the preferred way to load the EXs and User Sample Bank data in the KSC: load it into RAM, or use Virtual Memory. Note that if the data is extremely large, and would not fit into RAM regardless of which other samples were loaded, the data will use Virtual Memory regardless of this setting.

These settings apply only to EXs and User Sample Banks; Sampling Mode data is always loaded into RAM.

**RAM:** The samples will be loaded into RAM. This has the advantage of allowing reverse playback.

**Virtual Memory:** The samples will use Virtual Memory. This generally allows you to load more large samples at once. Note that the samples may still require a significant amount of RAM

**KSC Settings:** KSCs can store separate load method settings for each Multisample or Drumsample, based on the settings when the KSC was saved. Setting **Load Method for EXs and User Sample Banks** to **KSC Settings** uses these individual settings.

### 13. Press the OK button to load the data.

 Never remove or disconnect USB storage devices while data is being loaded.

---

## Loading multiple files at once

You can use “wildcards” to specify multiple .KMP, .KSF, .AIF, .WAV, SoundFont 2, Akai Program, and Akai Sample files, and load them simultaneously. For more information, see “Loading multiple files at once” on page 837 of the Parameter Guide.



## Supported file types

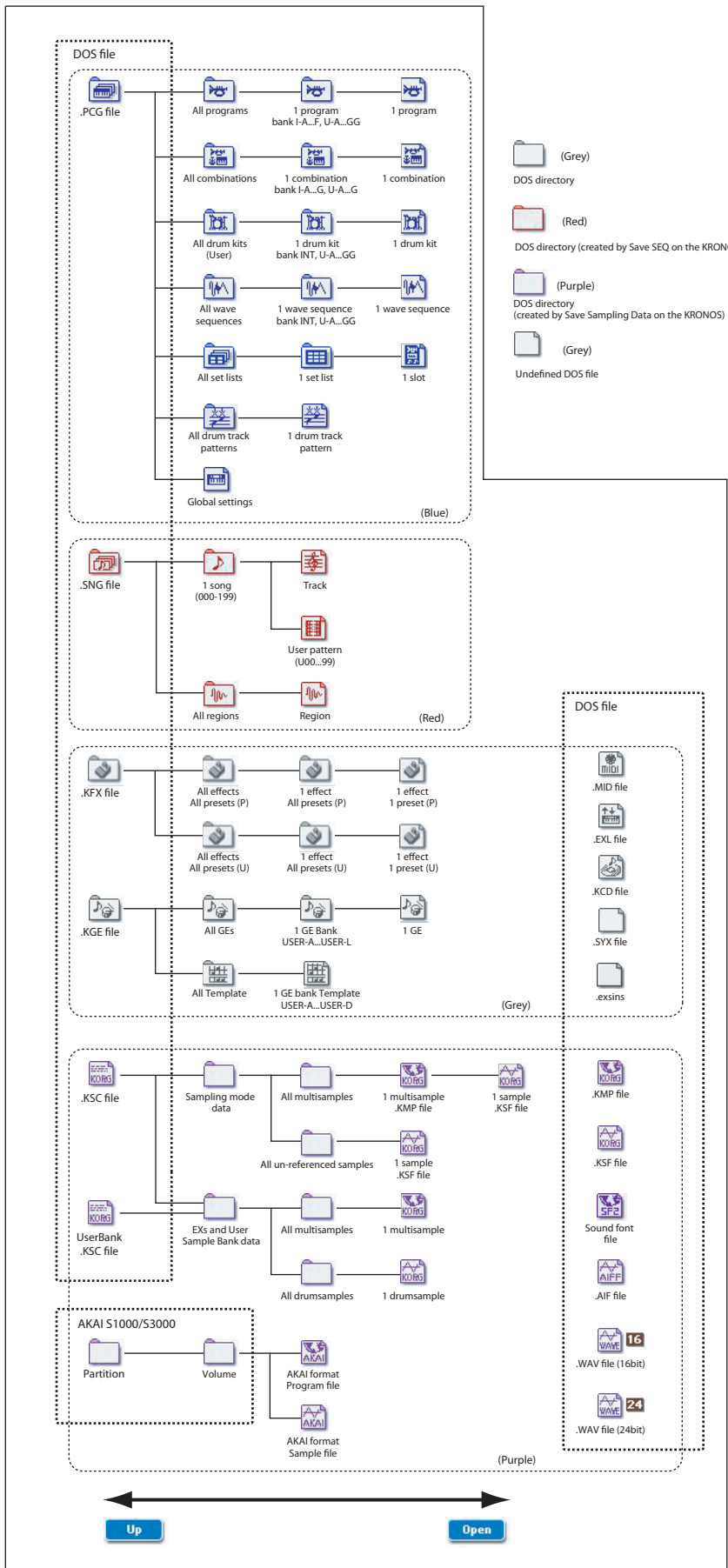

## Loading individual banks from a .PCG file

### 1. Select the .PCG file containing the data you want to load.

Refer to steps 1–4 of “Loading Songs, sounds, samples, and KARMA GEs together” on page 200.” Select the .PCG file in step 4.

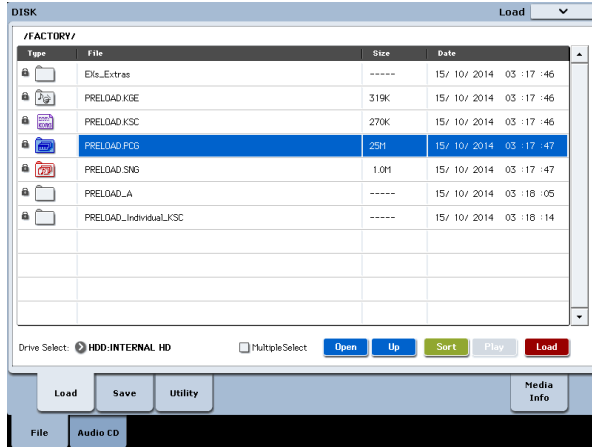

### 2. Press the Load button.

You can load individual banks by using “.PCG Contents” in the dialog box to select the load-source bank, and “To” to select the load-destination bank.

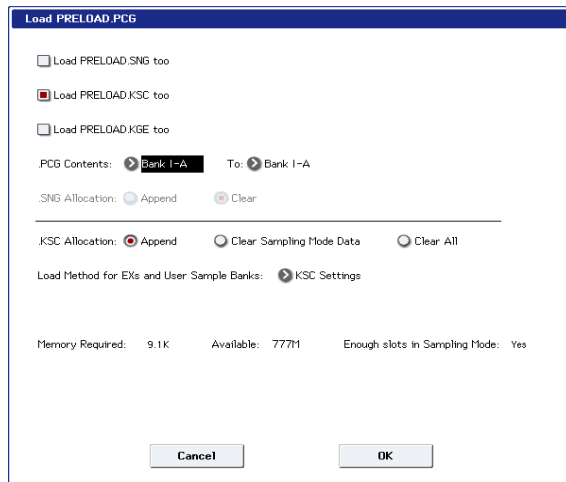

When you press OK, the source bank’s Programs, Combinations, Drum Kits, and Wave Sequences will be loaded into the destination bank. Global setting data will not be loaded.

If you set “.PCG Contents” to Bank INT–A, and “To” to Bank INT–A, data will be loaded as follows.

#### Programs

- Bank INT–A: loaded into Bank INT–A

#### Combinations

- Bank INT–A: loaded into Bank INT–A

#### Drum Kits

- INT: loaded into Bank INT

#### Wave Sequences

- INT: loaded into Bank INT

When data is loaded into a bank that is different than its original bank, the data (bank, program, pattern, and kit numbers, etc.) will automatically be reconfigured so that after loading, the various types of data will correspond correctly in each mode.

The following data will also be reconfigured automatically if you have checked “Load .SNG too” (so that song data is loaded at the same time), the following data will also be reconfigured automatically in order to ensure that the song data plays back correctly.

- The bank of each program used by combinations
- The bank of each drum kit and wave sequence used by each program
- The bank of the program used by each track of the song
- If the song contains track/pattern events, the program banks within these events

## Loading data by individual item or bank

The KRONOS lets you load programs, combinations, drum kits, and wave sequences individually or by individual banks.

This is a convenient way to rearrange combinations in the order in which you will use them during a live performance.

 Be aware that if you change the order of Programs, the sounds played by Combinations may also be affected.

As an example here, we will explain how a Combination saved in bank INT-F can be loaded into INT-E000.

### 1. Move to the “Bank INT-F” directory, and select the combination that you want to load. (.PCG file/Combinations/Bank INT-F/)

The procedure is as follows.

1) Perform steps 1–5 under “Loading Songs, sounds, samples, and KARMA GEs together” on page 200. Select the .PCG file containing the data you want to load (it will be highlighted), and press the Open button.

2) Press “Combinations” to highlight it, and press the Open button.

3) Press “Bank F” to highlight it, and press the Open button.

4) Press the scroll bar to find the combination you want to load, and highlight it in the display.

Alternatively, you could select any file, since the desired file can be selected later from the dialog box.

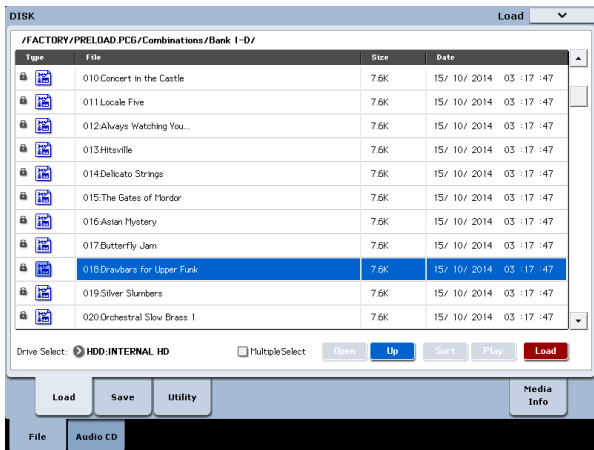

Note: When you press the keyboard of the KRONOS, the selected combination will sound. However, the internal programs will be used as the program of each timbre.

2. Press the page menu button and select the “Load Selected” page menu command.

The dialog box will appear.

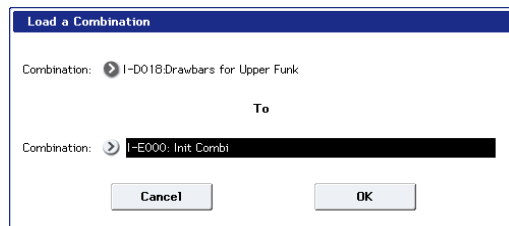

3. Use the “Combination” (upper line) to select the load-source combination, and use “(To) Combination” (lower line) to specify the destination combination. For this example, select INT-E000.

As shipped from the factory, this Combi location is empty; it has no name, and makes no sound.

4. Press the OK button to execute loading; the loaded combination will be assigned to INT-E000.

## Loading the samples required by Programs or Combinations

### Loading samples required by a single Program or Combination

Programs and Combinations may sometimes require sample data that’s not currently loaded. If this happens, the message **Samples Not Loaded** appears at the top of the display. You can easily load the required sample data, and save the results so that it can be loaded automatically in the future. To do so:

1. Go to the P0:Play page for the Program or Combination.
2. Select the menu command **Load required samples**.

This command is only available when the **Samples Not Loaded** message appears at the top of the display.

A dialog box will appear, with a list of all of the missing Multisamples, Samples, and/or Drum Samples required by the Program or Combination, including the bank(s) containing the data.

3. Select the “Load only required samples” radio button to load the listed data.

The bottom of the dialog box shows the **Memory Required** and (Memory) **Available**. If there isn’t enough room to load the samples, you’ll need to un-load other samples before continuing.

4. Press **Load** to load the data, or **Cancel** to exit without loading.
5. Repeat as desired for other Programs or Combinations.

If you’d like to automatically load the sample data in the future:

6. Save the result as a new KSC file.

To do so, follow the instructions under “Saving a KSC file” on page 176.

7. Set up the new KSC file to load automatically at startup.

Follow the instructions under “Adding a KSC to the list” on page 174.

### Creating a custom sample set

**Load required samples** also lets you create custom sample sets based on your favorite Programs, even if they use different EXs or User Sample Banks. To do so:

1. Save any data you’ve created in Sampling Mode. (The next steps will erase all Sampling Mode data.)

For more information, see “Saving a KSC file” on page 176.

2. Go to the KSC Auto-Load page in Global mode.
3. Un-check all KSCs.
4. Press the **Do Auto-Load Now** button.

This clears out all other sample data, so that the KSC you eventually save will include only the data loaded in step 5, below.

5. One by one, select the desired Programs. For each one, use the **Load required samples** command to load its sample data.
6. Save a new KSC with a different name (such as **Custom.KSC**), with **Include** set to “Links to EXs and User Sample Banks.”

For more information, see “Saving a KSC file” on page 176.

This new KSC now links to all of the sample data required by the Programs.

7. Go to the KSC Auto-Load page in Global mode, and re-enable KSCs as desired. Remember to include your newly-created KSC!

### Loading samples required by a bank of Programs or Combinations

If a bank of Programs or Combinations all require a specific EXs or User Sample Bank, you can easily load the whole bank of samples at once. To do so:

1. Go to the P0:Play page for the Program or Combination.
2. Select the menu command **Load required samples**.

**3. Select the Load complete banks radio button to load the entire bank(s) containing the data.**

Check the **Memory Required** and **(Memory) Available** to see that there's enough room to load the data.

**4. Press Load to load the data, or Cancel to exit without loading.**

If you'd like to automatically load the sample data in the future:

**5. Save the result as a new KSC file.**

To do so, follow the instructions under "Saving a KSC file" on page 176.

**6. Set up the new KSC file to load automatically at startup.**

Follow the instructions under "Adding a KSC to the list" on page 174.

## Creating and playing audio CDs

### Requires a USB CD-R/RW drive (not included)

If you have an external USB CD-R/RW drive, you can sample directly from audio CDs (as well as simply playing them), and create your own audio CDs.

## Creating audio CDs

In conjunction with an external USB CD-R/RW drive, you can use the KRONOS to create audio CDs of your music. To do this, you'll:

- Bounce the completed Songs to WAVE files
- Arrange the WAVE files in a track list, in the order that you'd like them to appear on the CD
- Burn the track list to a CD

### Part 1: Bouncing to disk

If you're starting with Songs you've created in Sequencer mode, you'll first need to bounce the Songs to WAVE files on the internal disk.

1. In Sequencer mode, select the first song that you want to burn to the CD.
2. Go to the 0–8: Audio In/Sampling page.
3. Select the menu command **Bounce All Tracks To Disk**. A dialog box will appear, showing the file system.
4. Use **Drive Select**, **Open**, and **Up** to select the directory in which the WAVE file will be saved.
5. Use **Name** to specify the WAVE file's name.
6. Press the **OK** button to start the bounce.

The Song will start playing. Recording will begin and end automatically, and the resulting stereo WAVE file will be saved to the disk.

Repeat the steps above for all of the Songs that you'd like to burn to the CD, and then proceed to Part 2 below.

### Make sure that there's space on the drive

- 🔍 When you create an audio CD, the KRONOS first saves a draft version of the CD onto the same drive that contains the original WAV files, and then burns the actual CD. This means that the drive must have enough free space to write a second, temporary copy of all the CD's WAVE files. Make sure that you have enough space before you start.

### Part 2: Making the CD

1. Press the **DISK** button to enter **Disk mode**.
2. Go to the **Audio CD—Make Audio CD** page.

This page lets you select a group of WAVE files to burn to the audio CD. Each WAVE file will become a track on the CD, and so we'll call this group of WAVE files the "track list." Before you add any files, the track list will show only "====End====."

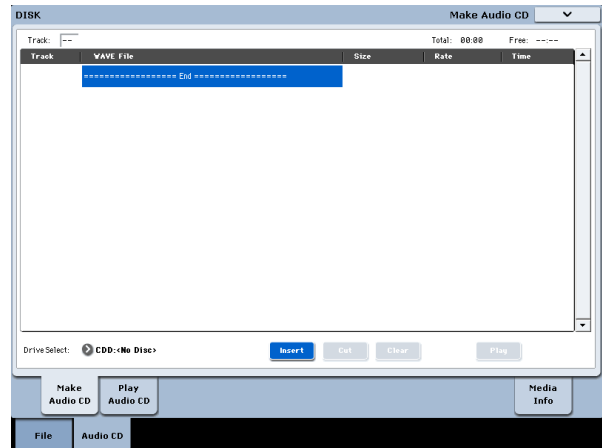

3. Add the WAVE files that you want to write to the CD. Select "====End====" (it will be highlighted), and press the **Insert** button.

The **Insert Track** dialog box will appear.

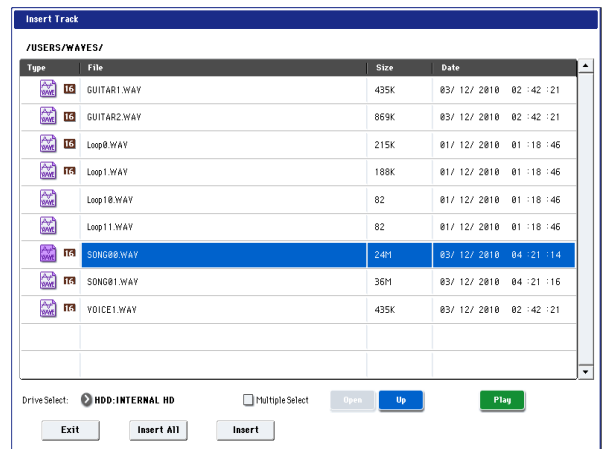

Use the drive select, **Open** and **Up** buttons to go to the directory that contains the WAVE file, and select the WAVE file that you want to add to the list.

You can press the **Play** button to play back the sample for auditioning. Alternatively, you can press the **SAMPLING START/STOP** switch to play it.

- 🔍 If you have selected a WAVE file with a sampling frequency other than 44.1 kHz or 48 kHz, it will not be possible to press the **Insert** button.
- 🔍 48 kHz WAVE files will be automatically converted to 44.1 kHz when you use the **Write to CD** command.

To add the file, press the **Insert** button.

You can continue adding files until you press the **Exit** button. The files will be added to the track list in the order in which you selected them. If you want to add all the WAVE files in the directory, press the **Insert All** button.

*Note:* If you check the **Multiple Select** option, you'll be able to select multiple WAVE files and insert them in a single operation.

When you have finished adding files to the list, press the Exit button to close the dialog box.

Notice that the WAVE files have been added to the track list.

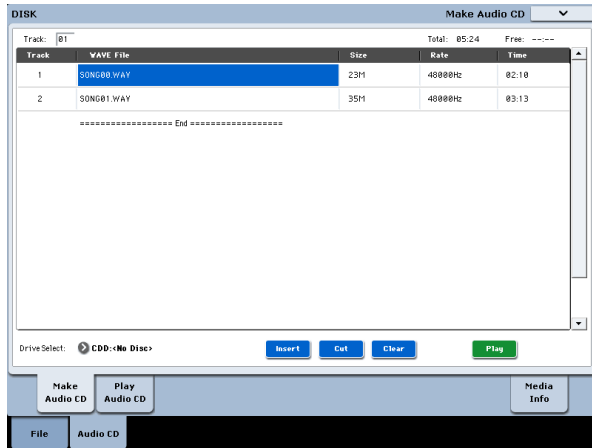

You can also use the Play button to play any 44.1kHz or 48kHz WAVE file.

To add other WAVE files to the track list, press the Insert button once again.

If you want to add another track, select the WAVE file that follows the track you want to add. If you want to add the track to the end of the track list, select "====End====." Then press the Insert button.

To delete a WAVE file from the track list, select the WAVE file that you want to delete, and press the Cut button. Subsequent tracks will be moved forward in the list.

*Note:* For more details on other editing operations, please see "1-1c: Drive Select, Command buttons" on page 824 of the Parameter Guide, and "Swap Track" on page 855 of the Parameter Guide.

**4. Insert a blank CD-R or CD-RW disk into the drive.**

In the Make Audio CD page, use **Drive Select** to select the external USB CD-R/W drive. The CD-R/W drive is shown as "CDD: Blank Disc."

 An audio CD cannot be created on a disc that contains data other than audio (e.g., files). In this case, it will not be possible to select the menu commands **Write to CD** or **Finalize Audio CD**.

*Note:* Since some audio CD players are unable to play back CD-RW media, we recommend that you use CD-R media for audio CDs.

**5. Select the menu command Write to CD to open the dialog box, and specify how the CD will be written.**

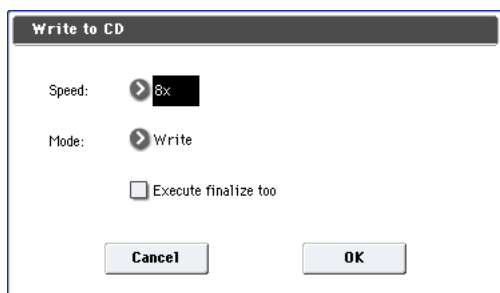

Use **Speed** to set the writing speed. This will indicate the speeds supported by the CD-R/W drive you are using. In this example, set the **Speed** to the lowest value available (such as 1x).

 In some cases, faster speeds may cause write errors.

Use **Mode** to specify the writing method.

*Note:* Depending on the drive you are using, it may not be possible to write at the specified speed. We recommend that the first time you write, you select Test to perform a writing test in order to determine the speed capabilities of your drive. Test will not write data to the CD-R/W media, but will perform all other processing just as when data is actually written. If an error occurs, the display will show the message "Error in writing to medium."

Press the OK button to execute the writing test.

After verifying that data can be written correctly at the specified speed, select Write.

**Execute finalize too** specifies whether Finalization will be executed after the audio tracks have been written to the CD-R/W media. If finalization has been executed, the disc can be played back on a CD player, but it will no longer be possible to add more tracks.

*Note:* If you only want to execute finalization, use the **Finalize Audio CD** command.

**6. When you are ready to write to the CD-R/RW media, or to execute a writing test, press the OK button. To cancel without executing, press the Cancel button.**

 When you press the OK button, the "Obey Copyright Rules" dialog box will appear.

**7. Carefully read "COPYRIGHT WARNING" on page 3 of the Quick Start Guide, and if you consent to the terms, press the OK button to begin burning the CD. If you do not consent to the terms, press the Cancel button to cancel the operation.**

 In order to avoid errors, do not subject the drive to physical shock or vibration while CD-R/W media is being written.

**Saving Track Lists**

The track list will be lost when the power is turned off. If you want to keep this data, you must save it.

1. In the Save page, select the directory in which you want to save the track list.
2. Select the page menu command "Save Audio CD Track List" to open the dialog box.
3. Press the OK button to save the data, or press the Cancel button to cancel without saving.

## Playing audio CDs

You can play audio CDs—including CDs you've created—directly on the KRONOS, in conjunction with an external USB CD-R/RW drive.

To do so:

1. Press the Play Audio CD tab to go to the Play Audio CD page.

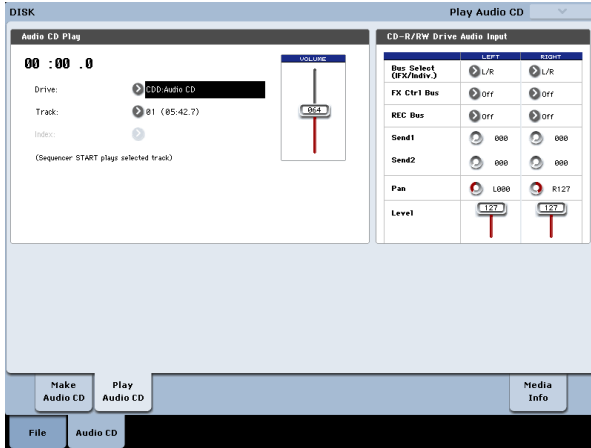

2. In Drive Select, select your USB CD-R/RW drive. Drive Select will indicate Audio CD.
3. To allow monitoring, set the CD-R/RW Drive Audio Input as follows.  
LEFT: Bus (IFX/Indiv.) L/R, FX Ctrl Bus Off, REC Bus Off, Send1/Send2 000, Pan L000, Level 127  
RIGHT: Bus (IFX/Indiv.) L/R, FX Ctrl Bus Off, REC Bus Off, Send1/Send2 000, Pan R127, Level 127  
Volume: 127
4. Use Track to select the track, and press the SEQUENCER START/STOP switch to begin playback.



## Other disk operations

---

### Setting the date and time

KRONOS has an internal calendar, which is used to record the date and time when you save data. You can set the date and time by using the Disk Utility page's **Set Date/Time** menu command.

You will need make these settings after you purchase the KRONOS, and after replacing the calendar backup battery.

1. **Press the DISK button to enter Disk mode.**
2. **Select the Disk–Utility page. Press the File tab, and then the Utility tab.**
3. **Open the page menu, and select the Set Date/Time command.**

The following dialog box will appear.

4. **Use the VALUE controllers to set the correct year, month, day, hour, minute, and second.**
5. **Press the OK button.**

 If the calendar backup battery runs low, the following message will appear in the LCD screen:

“The clock battery voltage is low. Please replace the battery, and set the date and time in Disk mode”

If the calendar backup battery runs down completely, the calendar will be initialized, and the date and time will not be recorded correctly. Your Korg Distributor can help you find a service center to replace the battery.



# Using Effects

## Effects overview

### Effects basics

The KRONOS provides 12 insert effects, two master effects, and two total effects, together with a mixer that controls the routing of these effects. All of these are stereo in/out.

Specific parameters of these effects can also be controlled in real time from the KRONOS' controllers or via MIDI messages using Dynamic Modulation (Dmod), by MIDI/Tempo Sync, or by using a common LFO or the Vector EG to apply synchronized change to differing modulation effects.

### Effect types

You can choose from 197 different effects in the following categories:

*Effect types*

Dynamics: 000...010	Effects which control volume, such as compressors, limiter, and gates
EQ/Filter: 011...026	Effects which control frequency content, such as EQ, multi-mode filter, exciter, and wah
OD/Amp/Mic: 027...039	Overdrive and amp modeling effects such as guitar/bass amps and mic preamps
Cho/Fln/Phs: 040...054	Choruses, Flangers, Phasers, and other pitch and phase modulation effects
Mod/PShift: 055...076	Other modulation effects such as tremolo and rotary speaker, and pitch shifters
Delay: 077...099	Delays
Reverb/ER: 100...108	Reverb and early reflections
Mono-Mono: 109...140	Chains of two mono effects in series
Mono/Mono: 141...185	Dual Mono parallel effects, with independent mono effects for the left and right inputs
Vintage: 186...197	Collection of vintage effects from the EP-1 and CX-3

### Maximum number of effects and maximum voice polyphony

For each effect IFX1–12, MFX 1 and 2, and TFX 1 and 2, you are free to choose and use any of 197 types of effect. There is no limitation on the maximum number or type of effects you can use. During Smooth Sound Transitions, the KRONOS may use up to 34 effects at once (including the Set List EQ).

However, a certain amount of digital processing capability must be used in order to produce each effect. The Performance Meters page shows the amount of processing power currently being used. You can find this on the Perf Meters tab of P0 in Program, Combination, and Sequencer modes.

Please note that power used by the effects may sometimes have an impact on the available number of voices (although generally only in extreme conditions). For more information, see “About polyphony” on page 16.

### What is REMs *REMS*\* ?

*REMS* (Resonant structure and Electronic circuit Modeling System) is Korg's proprietary technology for digitally recreating the numerous factors that produce and influence a sound, ranging from the sound-production mechanisms of acoustic instruments and electric/electronic musical instruments, to the resonances of an instrument body or speaker cabinet, the sound field in which the instrument is played, the propagation route of the sound, the electrical and acoustic response of mics and speakers, and the changes produced by vacuum tubes and transistors.

## Effect I/O

### Insert effects

Insert Effects (IFX 1–12) are stereo-in/stereo-out. If you set **Wet/Dry** to Dry, the input signal will pass through without being processed by the effect. If you set **Wet/Dry** to Wet, the processed signal will be output in one of the following ways:

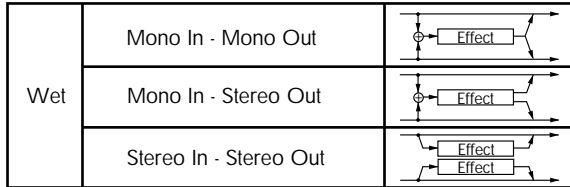

### Master Effects

The I/Os of Master Effects MFX1 and MFX2 are stereo-in/stereo-out. **Send1** and **Send2** determine the send level to the Master Effects.

Master effects will not output the Dry (unprocessed) signal specified in **Wet/Dry**. Only the Wet (processed) signal will be output. The output signals from the Master Effects are routed to the L/R bus with the output level specified by **Return1** and **Return2**. These output signals are mixed with the output signals from the bus specified by **Bus Select** (P8: “Routing” page in each mode) L/R, or with the output signals from the bus specified by **Bus Select** (“Insert FX” page in each mode) L/R, then routed to the total effect.

Selecting “000: No Effect” will mute the output. The processed signal will be output in one of the following ways, according to the type of effects 001–197.

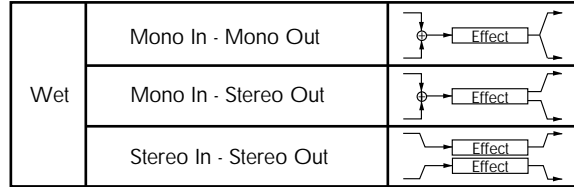

### Total Effects

The total effects TFX1 and TFX2 are stereo-in/stereo-out. The Dry (unprocessed) side of the **Wet/Dry** parameter sends the stereo input sound directly to the stereo output. The way in which the Wet (processed) side is output depends on the type of effect, as follows.

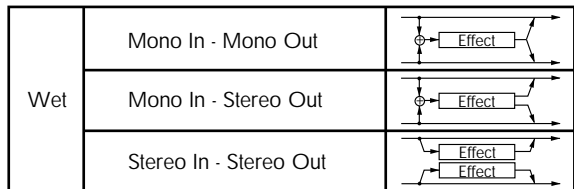

*Note:* The Parameter Guide includes block diagrams for each individual effect, which include the effect’s input/output structure.

### Set List EQ

Set Lists have an additional effects slot not available in the other modes: a dedicated nine-band graphic EQ applied to the sound after TFX2, which tailors the sound from the main stereo outputs (including the analog L/R outputs, S/P DIF, and USB).

For more information, see “Graphic EQ” on page 127.

## Effects in each mode

### Program mode

For HD-1 Programs, you can use insert effects to process the final sound in the same way that you use the Filter, Driver, Amplifier, and EQ (equalizer) to process the sound from the oscillators (OSC 1 & 2). Then the master effects are used to

*Program mode*

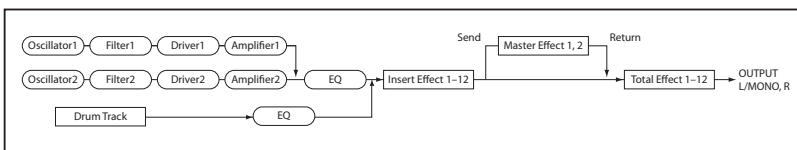

create overall ambience such as reverb, and use the total effects to make final adjustments. All of these settings can be made independently for each Program.

EXi Programs may have a different filter and amp structure for each type, but you can also apply insert effects, master effects, and total effects to EXi 1 & 2, just as for OSC 1 & 2

## Combination and Sequencer modes

In Combination and Sequencer modes, you can use the track EQ and insert effects to process the program sound (and audio track sound) of each timbre/track. Then you can use the master effects to create overall ambience, and use the total effects to make final adjustments.

### Combination and Sequencer modes

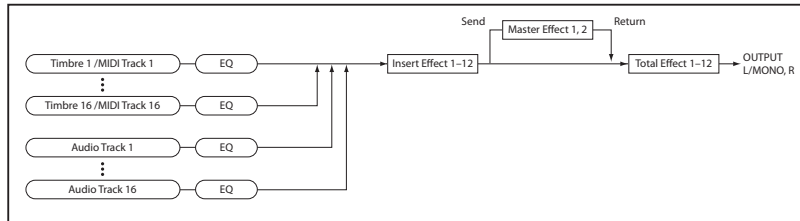

In Combination mode you can make these settings for each combination, and in Sequencer mode you can make them for each song.

In Sequencer mode, you can switch between effects or modify the effect parameters and record these changes, so that effects will switch automatically or effect parameters will be modified automatically as the song plays back.

## Sampling mode

In Sampling mode, the analog, S/P DIF, and USB audio inputs, as well as playback from a USB CD drive, can be processed by insert effects, master effects, and total effects,

### Sampling mode

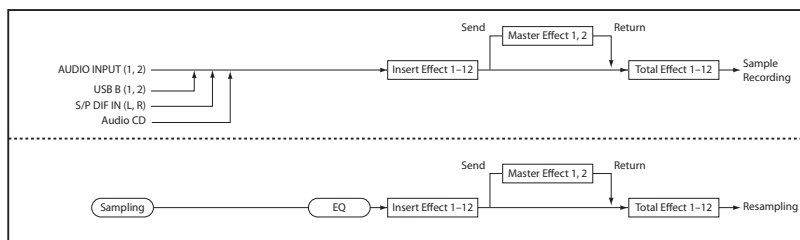

and then sampled. Use the P0: Recording– Audio Input page to make audio input settings for Sampling mode. These settings apply only to Sampling mode.

Samples that you’ve assigned as a multisample can also be processed by the insert effects, master effects, and total effects, and then resampled.

## Audio Inputs

You can also use audio from the analog, S/P DIF, and USB audio inputs in Programs, Combinations, and Songs.

You can apply the insert effects, master effects, and total effects to external audio sources and sample them, or use the KRONOS as a 6-in (AUDIO INPUT 1-2, S/P DIF IN L, R, and USB) 6-out effect processor.

You can also use an external mic input to control a vocoder effect (093: Vocoder), and modulate the internal sounds. For examples, see “Vocoder (Program mode)” on page 863 of the Parameter Guide and “Rhythmic Vocoder (Combination mode)” on page 864 of the Parameter Guide.

### Audio Inputs

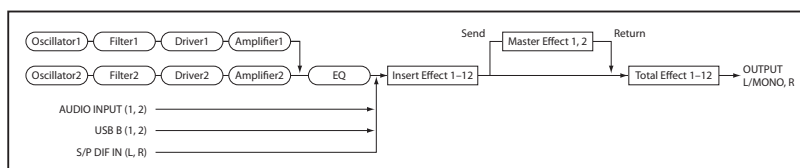

In Sequencer mode you can also use the effects when recording external audio sources to audio tracks.

Use the P0– Audio Input/Sampling page of each mode to make audio input settings. Alternatively, you can check **Use Global Setting** and make these settings in the Global mode P0: Basic Setup– Audio page. Normally you will leave **Use Global Setting** checked. Uncheck this if you want programs and combinations to use their own settings. For example when writing the program as a vocoder effect program.

 When effects are applied to the audio inputs, certain effect types or parameter settings may cause oscillation to occur. If this occurs, adjust the input level, output level, or effect parameters. Please be aware of this particularly when using an effect that has a high gain.

## Effects selection and routing

The insert effects, master effects, and total effects have the same structure in all modes, but the routing settings will determine how the oscillators of a Program, timbres of a Combination, or tracks of a Song will be sent to each insert

effect, master effect or total effect. In the pages that follow, we will explain how you can make routing settings and effect settings in each mode.

## Using effects in Programs

### Routing to IFX, outputs, and buses

#### 1. Go to the Program P8: Insert Effect– Routing page.

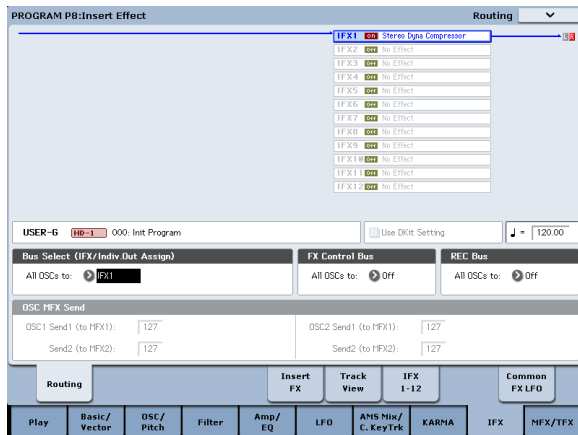

#### 2. Use Bus Select (IFX/Indiv. Out Assign) to specify the bus to which the oscillator output will be sent. If you want the oscillator output to be input to insert effect 1, choose IFX1.

**L/R:** The output will not be sent to the total effects. After passing through the total effect, the sound will be sent to AUDIO OUTPUT (MAIN) L/MONO and R.

**IFX1–12:** The output will be sent to insert effect IFX 1–12.

**1–4, 1/2–3/4:** The output will be sent to AUDIO OUTPUT (INDIVIDUAL) 1–4. It will not be sent to the insert effects, the master effects, or the total effects.

**Off:** The output will not be sent to AUDIO OUTPUT (MAIN) L/MONO, R, or to (INDIVIDUAL) 1–4. Choose this if you want the signal to be series-connected to the master effects at the send levels specified by “Send 1 (MFX1)” and “Send 2 (MFX2).”

#### 3. OSC MFX Send specifies the send level from each oscillator to the master effects.

This can be set only when “Bus Select (IFX/Indiv.Out Assign)” is either L/R or Off.

If “Bus Select (IFX/Indiv.Out Assign)” is set to IFX1–12, the send level to the master effects is set by **Send1** and **Send2** (Insert FX page) after the signal passes through the insert effects.

#### 4. “FX Control Bus (All OSCs to)” sends the oscillator 1 and 2 output to the FX Control bus. Use this if you want the audio input to the effect to be controlled by a different sound.

You can use the two FX Control buses to control effects freely.

#### 5. REC Bus sends the oscillator 1 and 2 output to the REC buses.

In the P0– Audio Input/Sampling page, you can set the Sampling Setup **Source Bus** to a REC bus, and sample the signal being sent to the REC bus. Normally you will turn this Off, since you will usually set **Source Bus** to L/R when sampling the output of oscillator 1 and 2.

### Drum Track routing

The Drum Track routing is controlled separately from the main Program. The options are very similar to those for the main Program, as described above. The Drum Track routing parameters are on the Program P1: Basic/Vector Drum Track page (P4 in EXi Programs).

### Insert effects

#### 1. Go to the Insert FX page.

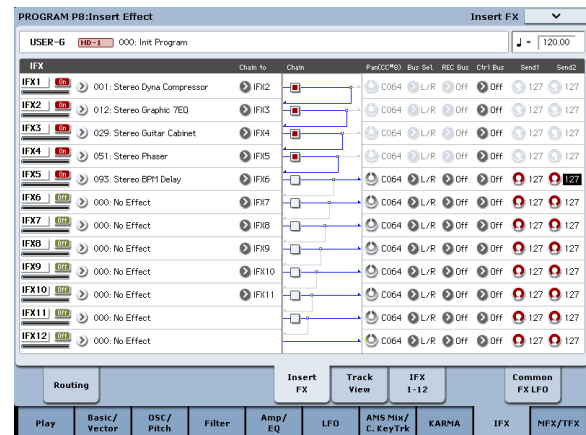

#### 2. Choose the effect type that you want to use for each insert effect IFX1–12.

When you press the popup button, all effects will be displayed, organized into nine categories. Use the pages located at the left to select a category, and select an effect from that category on the LCD screen.

You can use the “Copy Insert Effect” page menu command to copy effect settings from another program etc. Also, you can use “Swap Insert Effect” to exchange (for example) IFX1 and IFX12.

#### 3. Press the On/Off button to turn on the insert effect.

Each time you press the button, the insert effect will be switched on/off. When Off, the result will be the same as when 000: No Effect is selected. The input sound will be output without change.

#### 4. Make Chain settings.

If the **Chain** check box is checked, the insert effect will be connected in series. Since the output of the oscillator is being sent to IFX1 in step 2, making settings as shown in the diagram step 6 would connect all five insertion effects IFX1 → IFX2 → IFX3 → IFX4 → IFX5 in series, so that

these effects would be inserted into the output of the oscillator.

**5. Make settings for Pan (CC#8), Bus Sel. (Bus Select), Send 1, Send 2, REC Bus and Ctrl Bus for the sound after it has passed through the insert effects.**

If you've specified a chain, the settings that follow the last IFX in the chain will be valid (except for "Ctrl Bus").

**Pan:** Sets the pan of the IFX output.

**Bus Sel. (Bus Select):** Specifies the output destination. Normally you will set this to L/R. If you wish to send the sound that has passed through the insert effects to AUDIO OUTPUT (INDIVIDUAL) 1–4, select 1–4, 1/2, or 3/4.

**Send 1, Send 2:** Sets the send levels to the master effects. For this example, set this to 127.

**Ctrl Bus:** The FX Control Buses lets you create effects "sidechains." Sidechains let you control an effect with one audio signal (the sidechain), while the effect processes a completely different audio signal. This is convenient for use with vocoders, compressors and limiters, gates, etc. For more information, see "FX Control Buses" on page 862 of the Parameter Guide.

**REC Bus:** The sound processed by the insert effect will be sent to the REC bus. In the P0– Audio Input/Sampling page, you can set the Sampling Setup **Source Bus** to a REC bus, and sample the signal that is sent to the REC bus. Use this if you want to sample only the sound of an audio input source being processed by an insert effect (and not sample the sound of the oscillator output). Alternatively, the direct sound from the audio inputs can be mixed with the sound processed by an insert effect, sent to a REC bus, and sampled.

**6. Go to the P8: Insert Effect– Insert FX page, and edit the parameters of the insert effect you selected.**

Press the IFX 1–12 tab, use the tabs at the left to select IFX1–12, and edit the effect parameters.

**Effect 1 On/Off:** Turns the insert effect on/off. This is linked with the on/off setting in the Insert FX page.

**P (Effect Preset):** Selects an effect preset. The KRONOS' internal memory contains "effect presets" which are parameter settings for each effect from 001: St.Dyna Compressor through 197: Rotary Speaker Pro CX Custom.

Effect parameters you edit are saved as part of each program, but effect presets allow you to save favorite parameter settings for each effect. For more information, see "Effect Presets" on page 223.

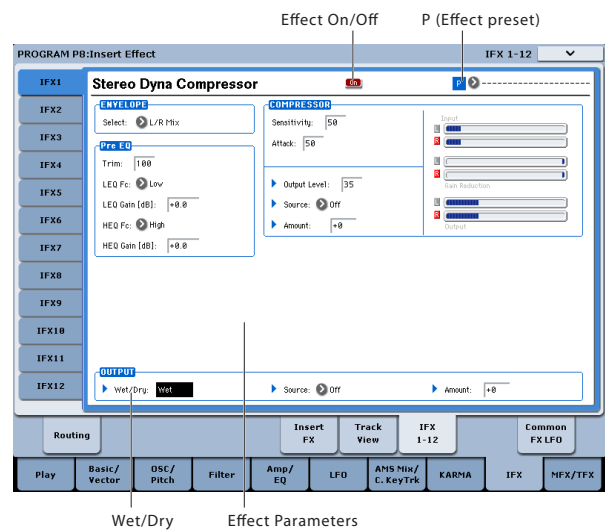

For details on the individual effects, see:

- "Dynamics" on page 891 of the Parameter Guide
- "EQ and Filters" on page 904 of the Parameter Guide
- "Overdrive, Amp models, and Mic models" on page 920 of the Parameter Guide
- "Chorus, Flanger, and Phaser" on page 929 of the Parameter Guide
- "Modulation and Pitch Shift" on page 942 of the Parameter Guide
- "Delay" on page 963 of the Parameter Guide
- "Reverb and Early Reflections" on page 985 of the Parameter Guide
- "Mono-Mono Serial" on page 990 of the Parameter Guide
- "Mono/Mono Parallel" on page 1006 of the Parameter Guide
- "Vintage" on page 1021 of the Parameter Guide

**Master effects**

The input levels to the master effects are set by the **Send 1 & 2** levels. If **Send 1 & 2** are zero, the master effects will not be heard. **Send 1** goes to MFX1, and **Send 2** goes to MFX2.

**1. Go to the Program P9: Master/Total Effect– Routing page.**

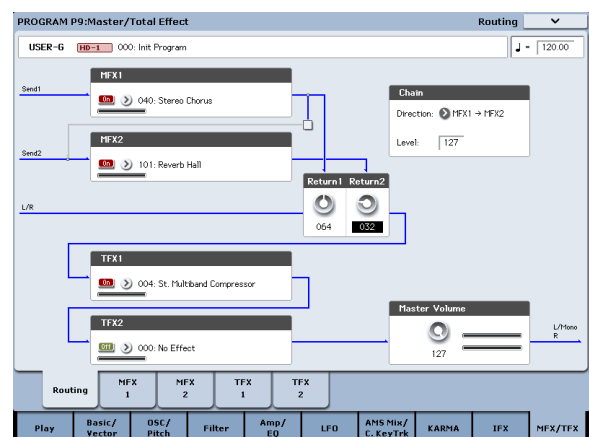

**2. In MFX1 and MFX2, select the type of each master effect.**



The procedure is the same as when selecting an insert effect.

**3. Press the On/Off button to turn on the master effect.**

Each time you press the button, the master effect will be switched on/off. When Off, the output of the master effect will be muted.

**4. Use “Return 1” and “Return 2” to adjust the output levels of the master effects.**

*Note:* For each effect, the Wet value of the **Wet/Dry** parameter is the output level at the effect. The return value is multiplied with this (“Return” = 127 will be x1.0) to determine the actual output level of the master effect.

**5. Select the MFX1 and MFX2 pages, and set the parameters for each selected effect as desired.**

The output from the master effects is sent to the total effects via the **Return 1** and **Return 2** settings on the Program P9: Master/Total Effect– Routing page.

After being processed through the total effects, the signal goes to the AUDIO OUTPUT (MAIN) L/MONO and R outputs.

**1. Go to the Program P9: Master/Total Effect– Routing page.**

**2. Choose the desired total effect for TFX1 and TFX2. The procedure is the same as when selecting an insert effect. (See step 7)**

**3. Press the On/Off button to turn the total effects on.**

The total effect will be switched on/off each time you press the button. If this is Off, the result will be the same as if 000: No Effect is selected. The input sound will be output without change.

**4. Access the TFX1 or TFX2 pages, and edit the parameters of each effect to adjust the final sound as desired.**

For details on the “Using effects in Programs” step 11.

**Total Effects**

If you use **Bus Select (IFX/Indiv.Out Assign)** to choose L/R as the oscillator output, or if you set the post-IFX **Bus Select** to L/R, the signal will go through the total effect.

**Using effects in Combinations and Songs**

In Combination, and Sequencer modes, you can specify the routing of each timbre/track to the insert effects, master effects and total effects. These settings are made in the same way in each of these modes. We will be using the example of Combination mode in our explanation here.

**Routing to IFX, outputs, and buses**

**1. Go to the Combination P8: Insert Effect– Routing1 page.**

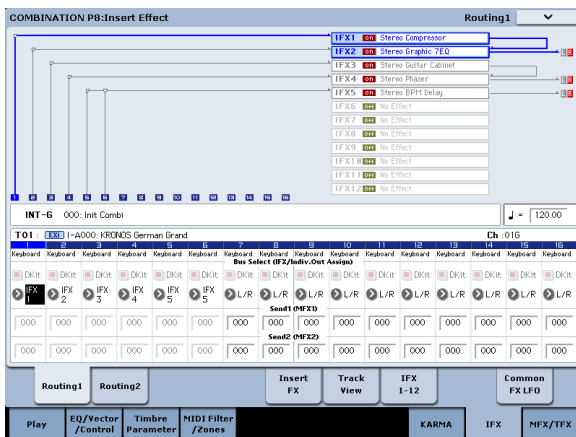

**2. Use “Bus Select (IFX/Indiv.Out Assign)” to specify the bus to which each timbre will be output. Choose IFX1 if you want to send the output of a timbre to insert effect 1.**

The routing, insert effects, and chain settings are shown graphically in the upper part of the display screen. In this example, T01 (timbre 1) uses IFX1 and 2. T02 uses IFX2, T03 uses IFX3 and 4, T02 and T05 use IFX4, and T06 and T07 use IFX5.

**3. Use Send1 and Send2 to specify the send level of each timbre to the master effects.**

This can be set only if “Bus Select (IFX/Indiv.Out Assign)” is set to L/R or Off.

*Note:* The actual send level is determined by multiplying this by the “Send 1” or “Send 2” settings for oscillators 1 and 2 within the program selected by the timbre. If the program parameter “Send 1” or “Send 2” is set to 0, the resulting level will still be 0 even if you raise this send level.

If “Bus Select (IFX/Indiv.Out Assign)” is set to IFX1–12, the send levels to the master effects are set by **Send1** and **Send2** (Insert FX page) following the insert effects.

**4. Go to the Combination P8: Insert Effect– Routing 2 page.**

**Bus Select (IFX/Indiv. Out Assign)** is the same as in the Routing 1 page. You can set it from either page.

**FX Control Bus** sends the output of the timbre to an FX Control bus. Use this when you want the audio input to an effect to be controlled by another sound. There are two FX Control buses, which gives you a great deal of freedom for controlling effects freely.

**REC Bus** sends the output of the timbre to a REC bus. In the P0– Audio Input/Sampling page, you can set the Sampling Setup **Source Bus** to a REC bus, and sample the signal that is sent to the REC bus. Use this if you want to sample only the sound of a specific timbre.

*Note:* Sequencer mode has settings for MIDI Routing 1/2 and Audio Routing 1/2. These specify the effect routing for MIDI tracks and audio tracks.

In Sequencer mode, you can also choose a REC bus as the **REC Source** for each track in the P0– Audio Track Mixer page, so that the signals sent to the REC bus(es) can be recorded to the disk.

## Insert effects

Continuing from the above:

1. Go to the Combination P8: Insert Effect– Insert FX page.

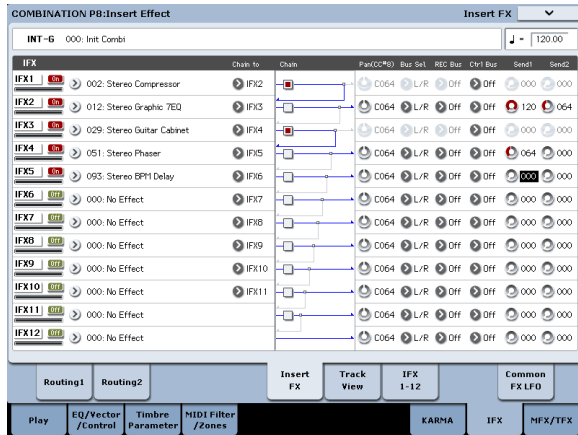

2. Choose the effect type that you want to use for each insert effect IFX1–12.

Press the popup button, and choose an effect from the nine categories.

3. Press the On/Off button to turn on the insert effect.

Each time you press the button, the insert effect will be switched on/off. When Off, the result will be the same as when 000: No Effect is selected. The input sound will be output without change.

4. Make Chain settings.

If the **Chain** check box is checked, the insert effect will be connected in series.

Make settings for **Pan (CC#8)**, “Bus Sel. (Bus Select),” “Send 1,” “Send 2,” **REC Bus** and “Ctrl Bus” for the sound after it has passed through the insert effects.

If you’ve specified a chain, the settings that follow the last IFX in the chain will be valid (except for “Ctrl Bus”).

**Pan:** Sets the pan.

**Bus Sel. (Bus Select):** Specifies the output destination. Normally you will set this to L/R. If you wish to send the sound that has passed through the insert effects to AUDIO OUTPUT (INDIVIDUAL) 1–4, select 1–4, 1/2, or 3/4.

**Send 1, Send 2:** Sets the send levels to the master effects. For this example, set this to 127.

**Ctrl Bus:** The FX Control Buses lets you create effects “sidechains.” Sidechains let you control an effect with one audio signal (the sidechain), while the effect processes a completely different audio signal. This is convenient for use with vocoders, compressors and limiters, gates, etc. For more information, see “FX Control Buses” on page 862 of the Parameter Guide.

**REC Bus:** The IFX output will go to the REC bus. In the P0– Audio Input/Sampling page, you can set the Sampling Setup **Source Bus** to a REC bus, and sample the signal that is sent to the REC bus. Use this if you want to sample only the sound of an audio input source being processed by an insert effect (and not sample the sound of the oscillator output). You can also use this if you want to sample only a specific timbre. Alternatively, the direct sound from the audio inputs can be mixed with the sound

processed by an insert effect, sent to a REC bus, and sampled.

*Note:* In Sequencer mode, you can also choose a REC bus as the **REC Source** for each track in the P0– Audio Track Mixer page, so that the signals sent to the REC bus(es) can be recorded to the disk.

**MIDI** You can use MIDI to control dynamic modulation (Dmod) for each effect, the post-IFX pan (CC#8), and Send 1 and Send 2.

An asterisk “\*” is shown at the right of Ch01–Ch16 for the channel number of tracks routed to IFX. If you’ve routed multiple tracks that have differing MIDI channel settings, this specifies the channel on which they will be controlled.

5. Go to the IFX1–12 pages to edit the individual effect parameters.

For more details, see step 6 under “Using effects in Programs,” beginning on page 214.

## Master effects and Total effects

These settings can be made in the same way as in “Using effects in Programs” (p.215).

**MIDI** You can control these effects via MIDI on the “Ctrl Ch.” The specified MIDI channel will control dynamic modulation (Dmod) for the Master and Total Effects.

## Using effects in Sampling mode

In Sampling mode, you can apply effects to external audio sources from the AUDIO INPUT 1–2 and S/P DIF IN jacks, and sample the result. You can also apply effects to the audio from a USB audio CD, and sample the result. It's also possible to apply effects to a multisample and resample the result.

### Routing an external input

1. Go to the Sampling P0: Recording– Audio Input page.

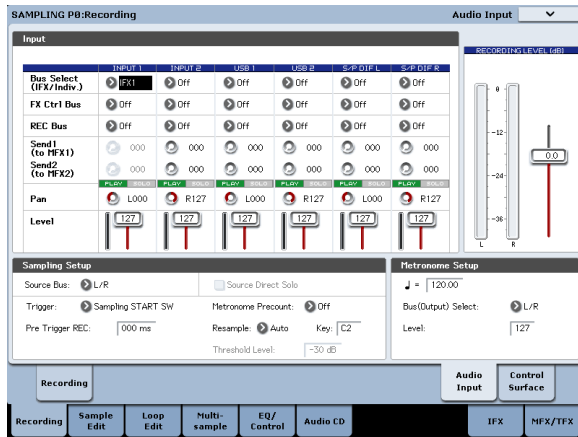

2. Use Bus Select (IFX/Indiv.) to specify the bus to which each audio input will be sent.

For example if you want the signal from a device connected to AUDIO INPUT 1 to be input to insert effect 1, set the INPUT 1 **Bus Select (IFX/Indiv.)** to IFX1.

3. Use Send1 and Send2 to specify the send level of each timbre to the master effects.

This can be set only if **Bus Select (IFX/Indiv.)** is set to L/R or Off.

If **Bus Select (IFX/Indiv.)** is set to IFX1–12, the send levels to the master effects are set by **Send1** and **Send2** (Insert FX page) following the insert effects.

4. Set PLAY/MUTE and Solo On/Off as desired. You can use the control surface to make these settings.

5. Use Pan to set the panning of the audio input.

If you're inputting a stereo audio source, you will normally set the inputs to L000 and R127 respectively.

6. Use Level to adjust the level of the audio input.

Normally you will leave this at 127.

7. FX Control Bus sends the output of the timbre to an FX Control bus.

The FX Control Buses lets you create effects “sidechains.” Sidechains let you control an effect with one audio signal (the sidechain), while the effect processes a completely different audio signal. This is convenient for use with vocoders, compressors and limiters, gates, etc. For more information, see “FX Control Buses” on page 862 of the Parameter Guide.

8. REC Bus sends the audio input to a REC bus.

By selecting a REC bus as the “Source Bus,” you can sample the signal that's being sent to the REC bus.

Normally when sampling in this mode, you will turn this Off, since the **Source Bus** will be set to L and R.

## Insert effects

1. Go to the Insert FX page.

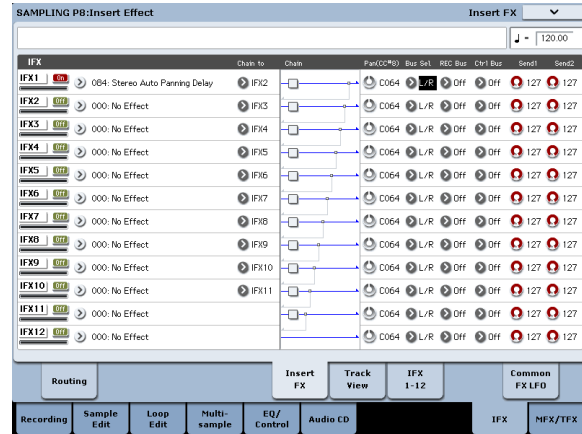

2. Choose the insert effect that you want to use on the audio input.

Press the popup button, and choose an effect from the nine categories.

3. Press the On/Off button to turn on the insert effect.

Each time you press the button, the insert effect will be switched on/off. When Off, the result will be the same as when 000: No Effect is selected. The input sound will be output without change.

4. Make Chain settings.

If the **Chain** check box is checked, the insert effect will be connected in series.

5. Make settings for Pan (CC#8), “Bus Sel. (Bus Select),” “Send 1,” “Send 2,” REC Bus and “Ctrl Bus” for the sound after it has passed through the insert effects.

If effects are chained, the settings that follow the last IFX are valid (except for “Ctrl Bus”).

**Pan:** Sets the pan.

**Bus Sel. (Bus Select):** Specifies the output destination. Normally you will set this to L/R. If you wish to send the sound that has passed through the insert effects to AUDIO OUTPUT (INDIVIDUAL) 1–4, select 1–4, 1/2, or 3/4.

**Send 1, Send 2:** Sets the send levels to the master effects. For this example, set this to 127.

**Ctrl Bus:** The signal processed by the insert effect will be sent to the FX Control bus. Use this if you want to use another sound to control the audio being input to an effect. You can use the two FX Control buses to control effects freely.

For more information, see “FX Control Buses” on page 862 of the Parameter Guide.

**REC Bus:** The sound processed by the insert effect will be sent to the REC bus. In the P0– Audio Input page, you can set the Sampling Setup **Source Bus** to a REC bus, and sample the signal that is sent to the REC bus.

Normally you will sample with **Source Bus** set to L/R and **REC Bus** turned Off. However by using the REC bus, the direct sound of the audio input and the sound

processed by the insert effect can be mixed to a REC bus and sampled.

**6. Access the IFX1–12 pages and edit the parameters of each effect.**

For more details, see step 6 under “Using effects in Programs,” beginning on page 214.

For details on applying an effect to an external audio input and sampling the result, see “Sampling external audio through insert effects” on page 145.

**Master effects and Total effects**

Master effects work the same as the do in Program mode, as described under “Master effects” on page 215.

**Sending the output of a multisample to an effect bus**

1. If you want the samples assigned to a multisample to be sent to an effect bus, go to the Sampling P8: Insert

**Effect– Routing page, and make settings for “Bus Select (All OSCs to)”.**

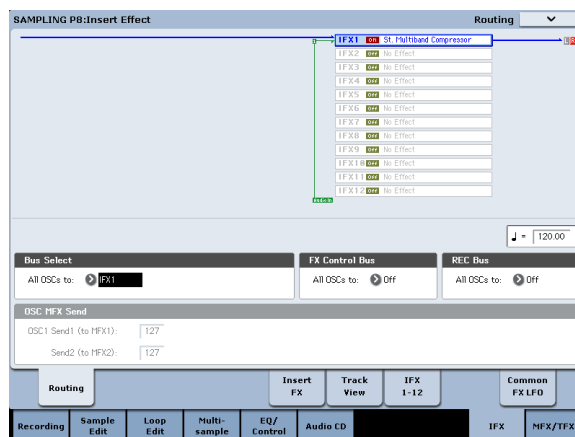

For details on resampling through effects, see “Applying an insert effect to a sample and resampling the result” on page 146.

**Using effects with the audio inputs**

Just as you can in Sampling mode, the Program, Combination, and Sequencer modes also let you apply the KRONOS’ effects to the signals from the analog, S/P DIF, or USB inputs and sample the result, or to use the KRONOS as a 6-in (analog, S/P DIF, and USB) 6-out effect processor. You can also use the KRONOS as a vocoder effect (026: Vocoder) that uses an external mic input to control the internal sounds.

Input-related settings are made in the P0– Audio Input/Sampling page of each mode. Normally, you will make settings in the Global mode P0: Basic Setup– Audio page and share these settings in all modes, but you can also make individual settings for a specific program (in Program mode) if, for example, you want to use that program as a vocoder.

**Routing to IFX, outputs, and buses**

1. Go to the Global P0: Basic Setup– Audio page.

*Note:* You must move to Global mode from the mode (other than Sampling mode) in which you want to input the external audio signals. If you move from Sampling mode to Global mode, the Audio Input settings of Sampling mode will be maintained, and you won’t be able to view the settings of this page.

These settings are not used in Sampling mode. Audio input settings for Sampling mode are made in the Sampling P0: Recording– Audio Input page.

 When applying effects to the signals from the analog, S/P DIF, or USB inputs, oscillation may occur depending on the effect type and parameter settings. If so, adjust the input level, output level, and effect parameters. In particular, use caution when using high-gain effects.

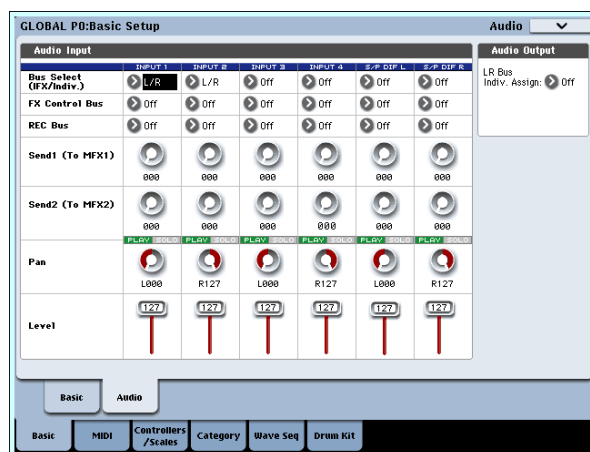

2. Use Bus Select (IFX/Indiv.) to specify the bus to which each audio input will be sent.

For example if you want the signal from a device connected to AUDIO INPUT 1 to be input to insert effect 1, set the INPUT 1 **Bus Select (IFX/Indiv.)** to IFX1.

3. Use Send1 and Send2 to specify the send level of each timbre to the master effects.

This can be set only if **Bus Select (IFX/Indiv.)** is set to L/R or Off.

If **Bus Select (IFX/Indiv.)** is set to IFX1–12, the send levels to the master effects are set by **Send1** and **Send2** (Insert FX page) following the insert effects.

4. Set PLAY/MUTE and Solo On/Off as desired. You can use the control surface to make these settings.

5. Use Pan to set the panning of the audio input. If you’re inputting a stereo audio source, you will normally set the inputs to L000 and R127 respectively.

6. Use Level to adjust the level of the audio input. Normally you will leave this at 127.

7. FX Control Bus sends the output of the timbre to an FX Control bus.

Use this when you want the audio input to an effect to be controlled by another sound. There are two FX Control buses, which gives you a great deal of freedom for controlling effects freely.

### 8. REC Bus sends the audio input to a REC bus.

In the P0– Audio Input/Sampling page, you can choose a REC bus as the Sampling Setup **Source Bus** so that the signal sent to the REC bus can be sampled or recorded (only in Sequencer mode).

- 🔊 Noise can enter the KRONOS via these buses; see “Avoiding extraneous noise” on page 97.
  - 🔊 If you want to save the edited settings in the KRONOS, you must write them. Use the Global mode page menu command **Write Global Setting** to do this.
9. If you want to use the Global mode Input settings in the other modes, check the “Use Global Setting” option.

If you want to make independent settings for programs, combinations, and songs, uncheck this setting.

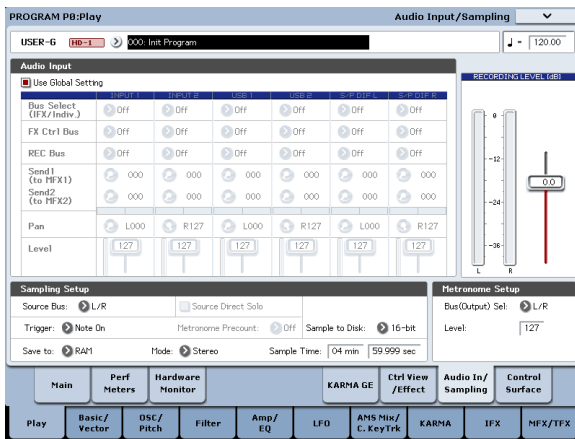

## Detailed effects editing

### Dynamic modulation (Dmod)

Dynamic modulation (Dmod) lets you use MIDI messages or the KRONOS's controllers to modulate specific effect parameters in real-time.

For more information, see “Dynamic Modulation Sources (Dmod)” on page 1106 of the Parameter Guide.

#### Dmod Example

As an example, let's set up dynamic modulation to control an effect parameter in real-time.

1. As described in the procedure for “Using effects in Programs” on page 214, set IFX1 to 091: L/C/R BPM Delay. Verify that you're hearing a delay effect.
2. Go to the Program P8: Insert Effect– IFX1 page.

#### Using Dmod to change the delay level via the Joystick

3. Set Input Level Dmod to +100.
4. Set Source to JS+Y: CC#01.

The delay sound will disappear.

The input level to the effect can be controlled by the joystick. As you move the joystick away from yourself, the delay sound will gradually increase.

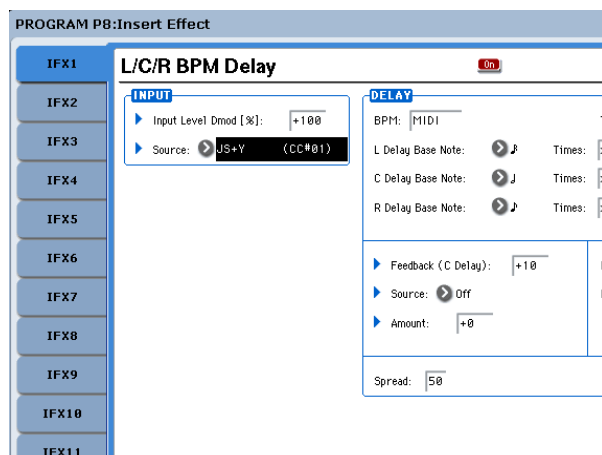

#### Using Dmod to change the feedback level via SW1

5. In the P1: Basic/Vector– Set Up Controllers page, set the SW1 function to SW1 Mod.CC#80, and the Mode to Toggle.
6. Choose P8. Set the Feedback Source to SW1 Mod. (CC#80), and set Amount to +30.

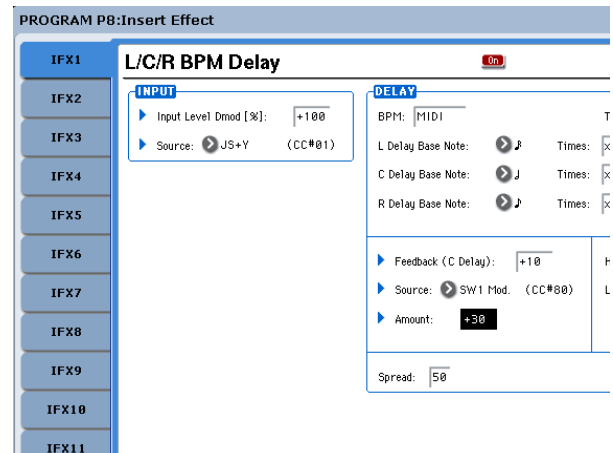

When you move the joystick away from yourself and press the SW1 switch, the feedback level will increase, and the delay sound will continue for a longer time. The **Amount** setting specifies the feedback level that will be in effect when the SW1 switch is pressed. If **Amount** is set to –10, pressing the SW1 switch will reduce the feedback level to 0.

## MIDI/Tempo Sync

MIDI/Tempo Sync lets you synchronize effects LFOs and delay times to the system tempo. For more information, see “Tempo Synchronization” on page 861 of the Parameter Guide.

#### Using MIDI/Tempo Sync to synchronize delay time to tempo

1. Set up the effects as described under “Dmod Example” on page 221.
2. Set BPM to MIDI.
3. For L, C, and R, set the Delay Base Note and Times as desired.

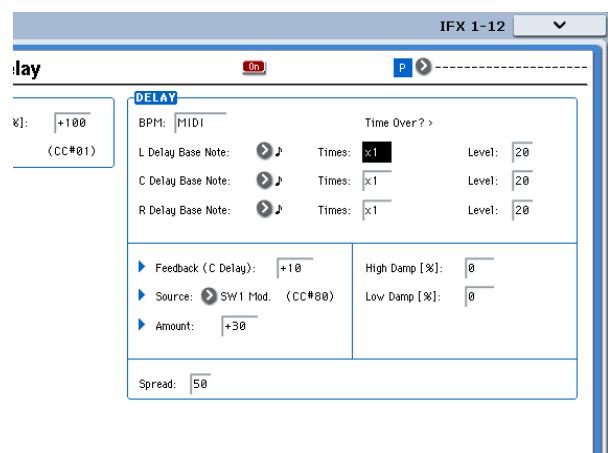



For this example, set **Delay Base Note** to  $\text{♩}$  and **Times** to x1 so that the effect will be easily understandable. The delay time will repeat at an interval of a 8th note.

**4. Rotate the TEMPO knob, and the delay time will change.**

When you (push the joystick away from yourself and) press the SW switch, the feedback level will rise, and the delays will become longer.

**5. When you turn on the KARMA ON/OFF switch, KARMA will begin playing.**

Select any desired KARMA GE. When you rotate the TEMPO knob, the delay time will change in synchronization with the changing tempo of the KARMA.

Depending on the specific delay effect, you may hear a noise if you change the tempo while the delay is sounding. This is because the delay sound becomes discontinuous, and is not a malfunction.

For some effects, you can synchronize the LFO frequency to the tempo. Set the effect parameters **MIDI/TEMPO Sync** to On, and **BPM** to MIDI. For more information, see “Tempo Synchronization” on page 861 of the Parameter Guide.

## Common FX LFO

Two Common FX LFOs are available for modulation effects, such as choruses, filters, phasers, etc. In the P8–Common FX LFO page of Program, Combination, Sequencer, or Sampling modes, you can specify the reset conditions and speed of Common FX LFO 1 and 2.

Normally, the LFOs of two or more modulation-type effects used simultaneously will not have synchronized phase even if you set them to the identical Frequency, since the LFOs are being generated independently.

However if you select Common 1 or Common 2 for the **LFO Type** parameter of a modulation-type effect, the effect will use not its own individual LFO but the Common LFO you specify here. This allows you to use a single Common FX LFO to simultaneously control two or more modulation-type effects such as flanger, phaser, or auto-pan with the same phase. Since you can make independent settings for LFO waveform and phase offset for each effect, you are free to create complex combinations of effects.

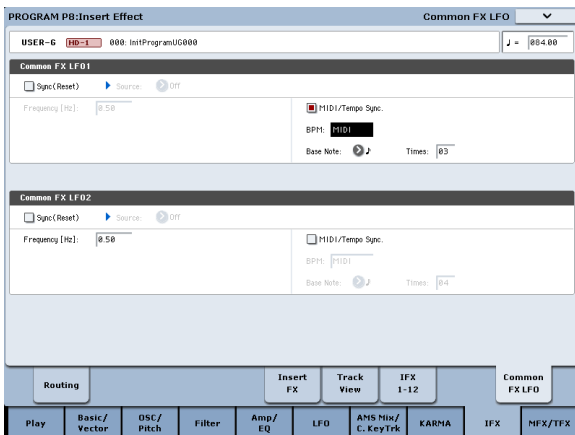
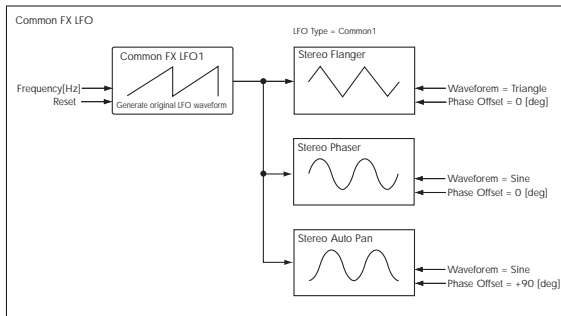
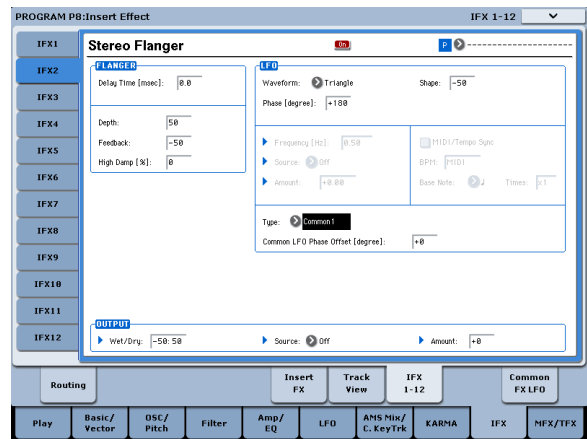



## Effect Presets

Effect Presets let you easily store and recall all of the settings for an individual effect. You can store up to 16 user presets for each effect type, in addition to 15 re-writable factory presets.

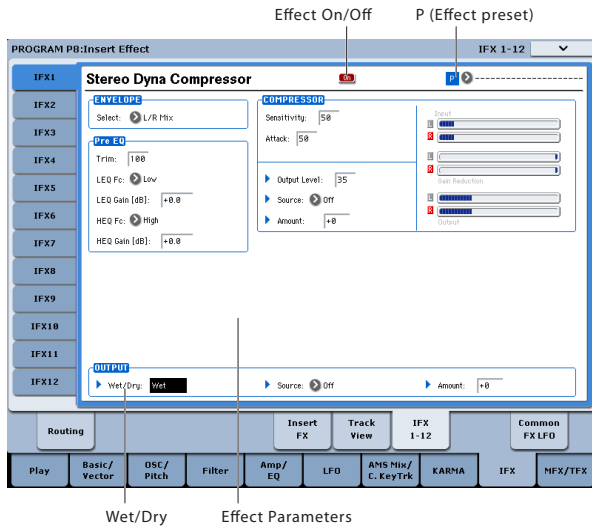

The same presets appear in all of the modes (Program, Combination, Sequence, and Sampling), and sets of presets can be saved to and loaded from disk.

Note that edits to effects parameters are automatically stored with the Program, Combination, or Song—you don't need to store them as an Effect Preset. Presets just make it easier to re-use your favorite settings.

For instance, you can save an Effect Preset while working on a particular Program, and then later use the same Effect Preset in a different Program, Combi, or Song.

**Note:** Programs, Combinations, and Songs save the effects parameter settings, but they don't save the number of the selected Effect Preset. If you select an Effect Preset, and then save the Program, the Effect Preset setting will revert to "-----."

## Selecting Effect Presets

1. Select an effect in the Insert FX page.
2. The P00: Initial Set settings will be recalled.  
"P (Effect Preset)" will show -----.
3. Use "P (Effect Preset)" to select an effect preset: P00–P15 or U00–U15.

The stored parameters will be recalled. Note that this will overwrite all parameters of the effect.

**P00: Initial Set:** These are the default settings that are recalled when you select an effect type in the Insert FX page. You can't save your own settings here.

**P01...P15:** These contain Korg preset data. We recommend that you store your settings in U00–U15.

**U00...U15:** These are areas in which you can store your own settings.

-----: This shows that no Effect Preset has been selected. You'll see this if you've just selected an effect, written a Program, or selected a new Program. Selecting this setting from the menu will not have any effect.

4. Edit the recalled parameters as desired.

## Saving Effect Presets

If you've come up with settings you like and want to save them as a new preset, you can save them.

1. On the IFX 1-12 page, touch the menu button to open the page menu.
2. In the menu, select the Write FX Preset command. The Write FX Preset dialog will appear.
3. Name the Preset as desired.
4. Open the "To" popup, and select the Preset number to save to.

You can save into any of the slots, but we recommend that you store your settings in U00–U15.

5. Press OK to save the Preset, or Cancel to exit without saving.



# Using KARMA

## Overview - What is KARMA?

KARMA stands for Kay Algorithmic Realtime Music Architecture, named after its inventor, Stephen Kay.

KARMA generates MIDI data, using many different algorithms seamlessly integrated to provide a powerful “music generation engine.” Based on the notes and chords you play, KARMA creates phrases and patterns in real-time, generating not just notes but MIDI control data as well. The KARMA architecture allows the various algorithms to be reconfigured and varied in realtime, as you play them.

For example, you can create the dynamic tempo changes that occur within a harp glissando, the synchronized changes in volume and tone that occur as part of a brass phrase, the randomness within a drum phrase, the crescendo and

diminuendo of a fill-in, changes in phrase or tone of a techno groove, complex interweaving phrases that would be impossible to play on a keyboard, guitar strumming and finger-picking simulations with natural-sounding changes, and backing grooves that follow your keyboard playing in realtime – all under your control. KARMA lets you produce phrases and patterns at a far more musical and flexible level than conventional arpeggiators or pattern playback functions.

On the KRONOS, KARMA is designed to work in close conjunction with the numerous other functions, giving you unbelievable performance power on stage or in the studio.

## The structure of KARMA

KARMA consists of the following major parts.

### KARMA modules

A KARMA module uses a GE (Generated Effect) to create a phrase or pattern.

In Program mode, only one KARMA module (A) is used. In Combination or Sequencer modes, four KARMA modules (A, B, C, D) can be used. For example, each module might be used to generate phrases and patterns for a separate sound, such as drums, bass, guitar, and piano.

**MIDI** In Program mode, the KARMA module transmits and receives all MIDI data on the Global MIDI channel specified by “MIDI Channel.”

In Combination and Sequencer modes, the MIDI data from each KARMA module is transmitted and received on the “Input Channel” and “Output Channel” specified for each module.

Based on note data from the keyboard, the GE uses various internal parameters to control how the note data will be developed, and how rhythm, chord structure, and velocity etc. will be controlled to generate a phrase or pattern. MIDI control changes and pitch bend data can also be generated in synchronization with the phrase or pattern. As a capability unique to the KRONOS, KARMA can generate MIDI exclusive messages to control wave sequencing, which switches between multisamples etc. of a program in realtime. This lets you create phrases and patterns in which the tone color and note pitches change independently.

The KRONOS provides a large number of GEs that can be used for a variety of instruments, performance techniques, and musical styles.

### GE RTP – Real Time Parameters

A GE consists of over two hundred internal parameters. In each GE, up to 32 of these internal parameters are pre-selected as the most suitable parameters for use in controlling the phrase or pattern. These parameters are called the “GE realtime parameters.”

### GE (Generated Effect)

The phrases and patterns produced by a KARMA module are created by a GE (Generated Effect).

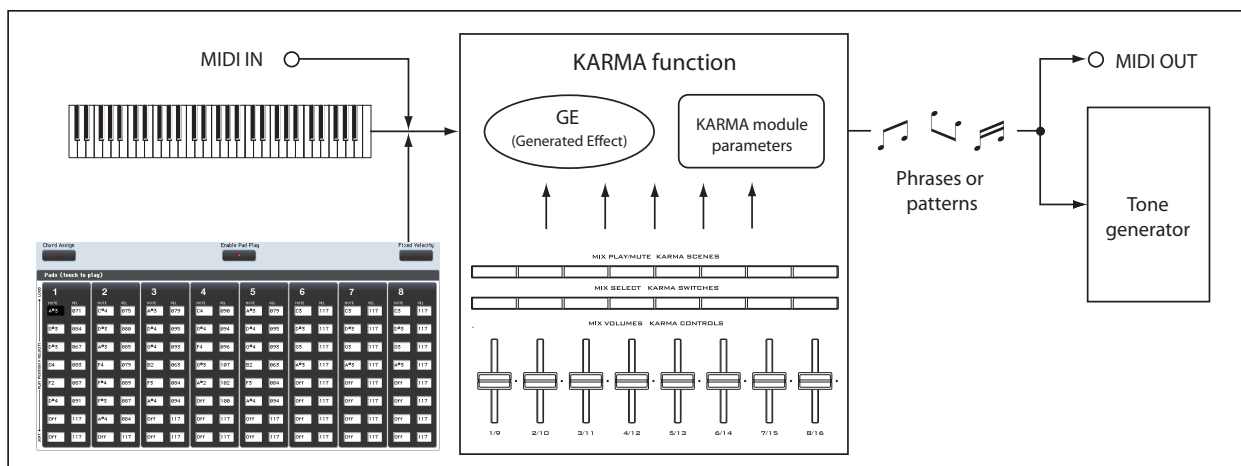

You can control the phrase or pattern by editing these parameters, or by assigning them to the KARMA CONTROLS sliders or KARMA SWITCH buttons and operating these during your performance.

KARMA - Program mode

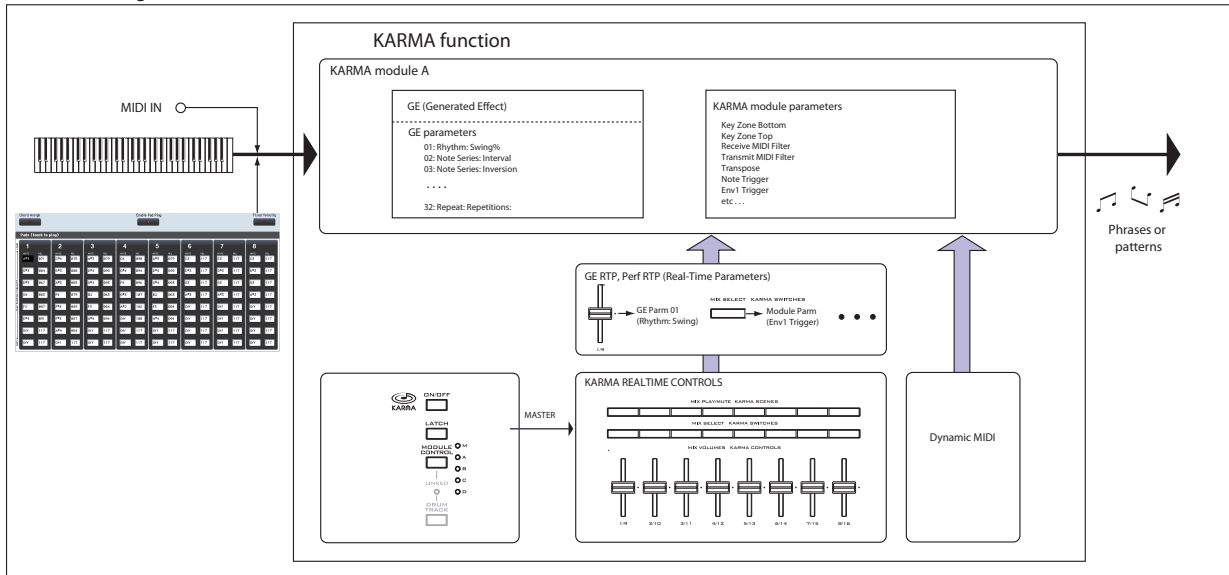

KARMA - Combination/ Sequencer mode

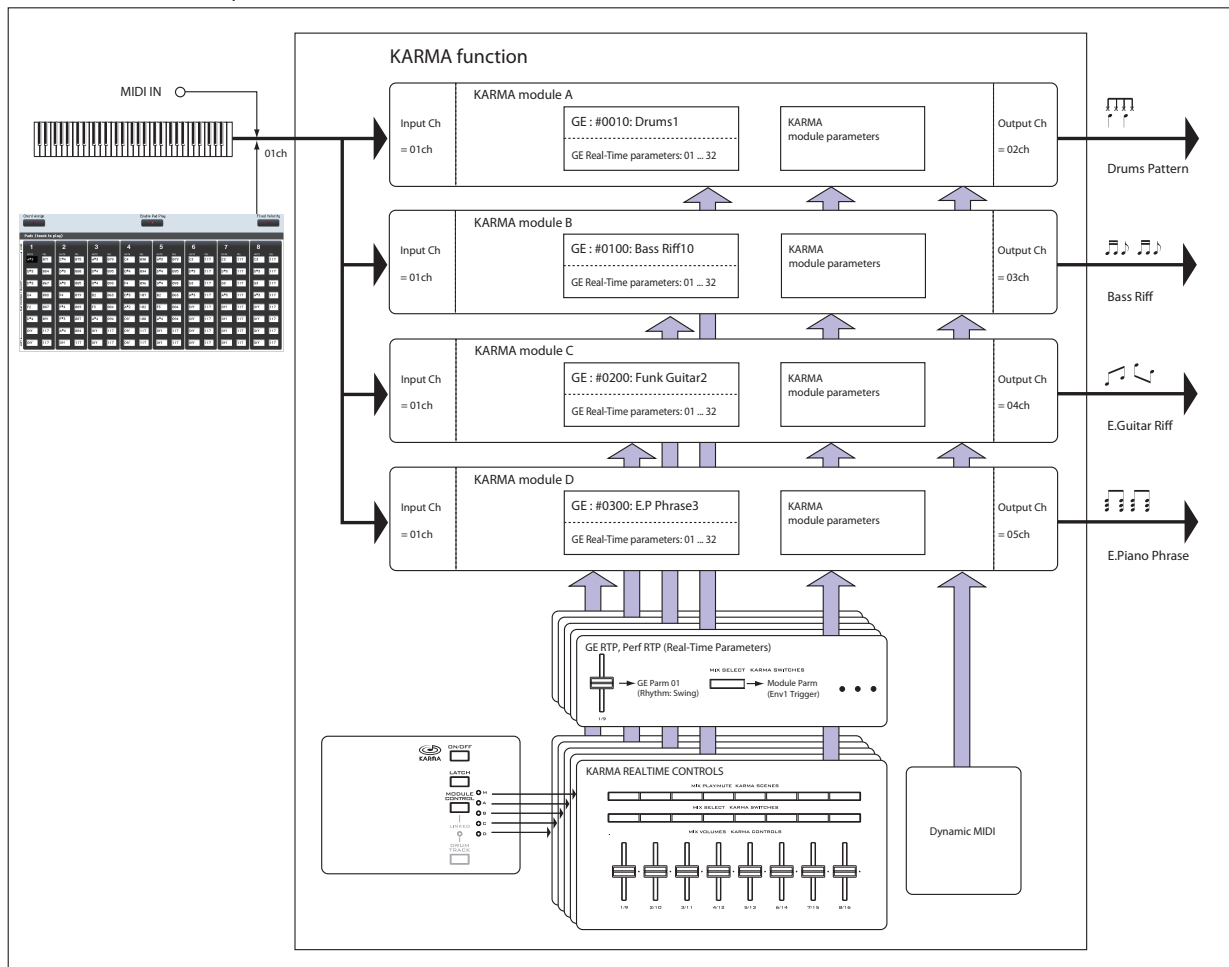

## RTC Model

All of the preset GEs have an internally-specified RTC Model. The RTC Model is a certain standardization of the more than two hundred internal parameters of the GE, based on the type and purpose of that GE.

GEs for which the same RTC Model has been specified will (by default) have the same parameters assigned as their GE realtime parameters. This means that even if you're switching through various GEs that have the same RTC Model, you will be able to control them in a uniform manner and make valid comparisons between them, since their default state will be the same. Of course, you are free to edit the GE realtime parameters.

In the pre-loaded programs and combinations, the KARMA CONTROLS sliders and switches are assigned in a uniform manner depending on the RTC Model for the GE used by each module. For example if a KARMA module used by a program or combination uses a GE of the Drum/Percussion category, the KARMA REALTIME CONTROLS sliders and KARMA SWITCHES will be assigned so that Slider 1 controls the swing and Slider 2 controls the pattern variation. Of course, you are also free to edit the REALTIME CONTROLS assignments.

Each GE is assigned one of the following RTC Models.

- DP1 - Drum/Perc
- BL1 - Bass/Lead
- DM1 - Drum Melodic
- GV1 - Gated Vel/Pattern
- GC1 - Gated CCs
- CL1 - Comp/Lead
- WS1 - WaveSeq 1
- WS2 - WaveSeq 2
- EG1 - Dual Env Gen
- LF1 - Dual LFOs
- MR1 - Melodic Repeat
- MB1 - Mel Rpt/Bend
- RB1 - Real-Time Bend
- Custom - a few GEs may require special RTC setups, outside of the normal RTC Models. In this case, the assignment of RTC Controls is left up to the sound designer of the specific Program or Combination.

An example is 2028: VJS Motion. If you load this GE, it clears all RTC Model assignments (when the GE Load Options are set to the default setting). With such GEs, it's generally best to copy the Module from an existing Program, so that you have an example of how to map the controls.

## Auto RTC Setup

This is a convenient function that automatically makes KARMA CONTROLS sliders and KARMA SWITCH assignments according to the RTC Model setting of a GE. Use the Load GE Options dialog box to make these settings automatically. Here you can choose whether you want KARMA controller assignments to be made automatically when you use the GE Select parameter to select a GE. If you've chosen "Auto RTC Setup" in this dialog box, the assignments will be made automatically each time you

change the GE. This means that regardless of the type of GE that's selected, you will immediately be able to use the standard KARMA CONTROL assignments.

---

## KARMA module parameters

These are the parameters that control the phrases and patterns generated by a KARMA module.

You can set these parameters independently for each KARMA module. These parameters include the GE selection, MIDI input/output channel, key zone, MIDI filtering, and triggering.

---

## GE RTP (GE Real-Time Parameters) Perf RTP (Perf Real-Time Parameters)

These are the parameters that you can control via the KARMA CONTROLS sliders or KARMA SWITCHES.

If GE realtime parameters (GE RTP) and KARMA module parameters (Perf RTP) are assigned to the KARMA CONTROLS sliders and KARMA SWITCHES, you'll be able to control them in realtime to modify the phrase or pattern while you play.

---

## Dynamic MIDI

Dynamic MIDI is a function that uses the KRONOS' controllers or MIDI control messages to control specific functions of KARMA.

For example, this enables you to use the joystick to play strummed guitar chords, use a foot switch to control the Run/Mute status of a KARMA module, or use the damper pedal to latch a KARMA module. You'll be able to control them in realtime while you play.

---

## KARMA CONTROLS

These are front panel controls used to control KARMA. The settings of these controls can be saved independently for each program, combination, and song.

### ON/OFF switch

This switches KARMA on/off.

### LATCH switch

If this is on, the phrase or pattern will continue playing even after you remove your hand from the keyboard.

### MODULE CONTROL switch

In Combination or Sequencer mode, this selects the module that will be controlled by the KARMA sliders 1–8, KARMA SWITCHES 1–8, and KARMA SCENE switches 1–8.

**MASTER:** Choose this setting if you want to control modules A, B, C, and D simultaneously. For example, this lets you use slider 1 to control the GE realtime parameter Swing for all modules A, B, C, and D.

**A, B, C, D:** Choose one of these settings if you want to control the corresponding module individually.

**Note:** In Program mode only MASTER can be selected, and module A will be controlled.

### **KARMA CONTROLS sliders 1–8**

#### **KARMA SWITCHES 1–8**

#### **KARMA SCENES 1–8**

When CONTROL ASSIGN is set to RT KNOBS/ KARMA, these control the KARMA module(s) selected by MODULE CONTROL.

By operating these controls, you can adjust GE realtime parameters and KARMA module parameters to freely vary the phrases or patterns generated by the KARMA module. (Use “GE RTP, Perf RTP” to specify the parameter that each control will affect.)

#### **SCENE switches**

These switches let you store the settings of sliders 1–8 and switches 1–8 as eight different “scenes” (SCENE 1–8). In Combination or Sequencer modes, scenes can store separate settings for each module, and you can use the MODULE CONTROL switch and the Scene Matrix function to control this.

For more information, see “7–5d: Module Control Scene Matrix” on page 483 of the Parameter Guide.

## Performing with KARMA

Based on your keyboard playing or on the note data received from MIDI IN, KARMA automatically generates a diverse variety of phrases or patterns, such as guitar or keyboard backing riffs, bass phrases, or drum patterns. You can use the KARMA CONTROLS sliders and the KARMA SWITCHES to freely modify these phrases or patterns.

The KRONOS contains pre-loaded programs and combinations that take full advantage of KARMA, covering a wide range of instruments, playing techniques, and musical genres. In these programs and combinations, the parameters most useful for controlling KARMA have been assigned to the KARMA CONTROLS sliders and KARMA SWITCHES.

## Performing with KARMA in Program mode

In Program mode you can use one KARMA module to generate a phrase or pattern appropriate for the sound of the program.

### Selecting a Program and switching KARMA on/off

1. Press the PROG switch to enter Program mode, and select the desired program. (See “Selecting Programs” on page 31.)

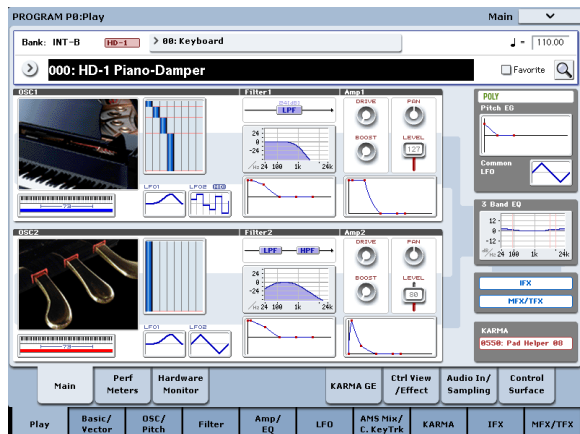

As you step through the programs, you’ll find some programs for which the KARMA ON/OFF switch LED is lit.

Press a key or on-screen pad (on the P1: Basic/Vector-Pads page), and KARMA will begin playing.

In other Programs as well, you can press the ON/OFF switch (LED lit) to turn KARMA on.

Note: If the Drum Track is on, and the Trigger Mode is set to Wait KBD Trig, the Drum Track will start playing simultaneously.

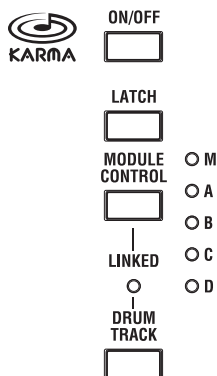

### Adjusting the performance tempo

1. Use the TEMPO knob or the TAP TEMPO switch to adjust the performance tempo.

This will change the “♩=” value located in the upper right of the display. You can adjust the tempo in a range of 40.00–300.00. The LED located above the TAP TEMPO switch will blink at intervals of a quarter note (♩).

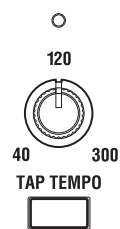

As an alternative to using the TEMPO knob or the TAP TEMPO switch, you can choose “♩=” in the display, use numeric keys 0–9 to enter the tempo, and then press the ENTER switch. You can also use the VALUE controller to set the tempo. The LED will blink at the tempo you specify.

**Note:** The setting of the TEMPO knob is also saved when you write a program.

- ⚠ If the Global P1: MIDI–MIDI page **MIDI Clock** parameter is set to External MIDI or USB, or if it’s set to Auto MIDI or USB and the KRONOS is currently receiving MIDI clocks, the **Tempo** display will indicate “♩=” EXT, and the KRONOS will be synchronized to an external MIDI device. In this case, you won’t be able to change the tempo by operating the KRONOS.



### Checking note-on/off and key zone

The screen shown below is a realtime display of the note data received from the keyboard, pads 1–8, and MIDI IN, and the note on/off data generated by the KARMA module, together with the name of the chord that was detected.

1. Go to the Program P0: Play– KARMA GE page.

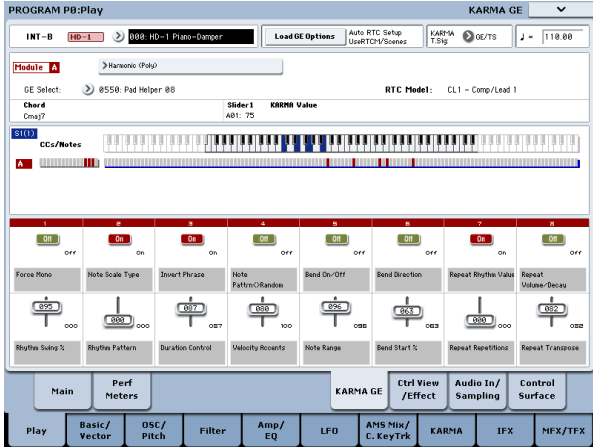

When you play the keyboard, the name of the chord detected by the KARMA module will appear in the “Chord” field of KARMA Module Info.

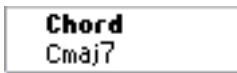

The CCs/Notes area shows the key zone of the KARMA module, and the state of the control data and note on/off data generated by the KARMA module. (See “Setting KARMA’s keyboard zone” on page 236.)



### Using the KARMA controllers

**Note:** The state of the KARMA controllers is saved when you write the program.

#### KARMA on/off: ON/OFF switch

KARMA will turn on/off each time you press the ON/OFF switch. If it is on, the switch LED will light. When you play the keyboard, the GE selected for the KARMA module will start generating a phrase or pattern.

#### Making the performance continue after you remove your hand from the keyboard: the LATCH switch

You can make KARMA continue playing even after you remove your hand from the keyboard.

LED lit: Latch is on. The performance will continue even after you remove your hand from the keyboard.

LED dark: Latch is off. The performance will stop when you remove your hand from the keyboard.

### Modifying the phrase or pattern generated by the KARMA module: KARMA CONTROLS 1–8 sliders, KARMA SWITCHES 1–8, SCENE 1–8 switches

Parameters useful for controlling the phrase or pattern are already assigned to the KARMA CONTROLS 1–8 sliders, KARMA SWITCHES 1–8, and SCENE 1–8 switches. You can operate these controllers to create a wide range of changes in the phrase or pattern that’s playing.

1. Go to the Program P0: Play– KARMA GE page.

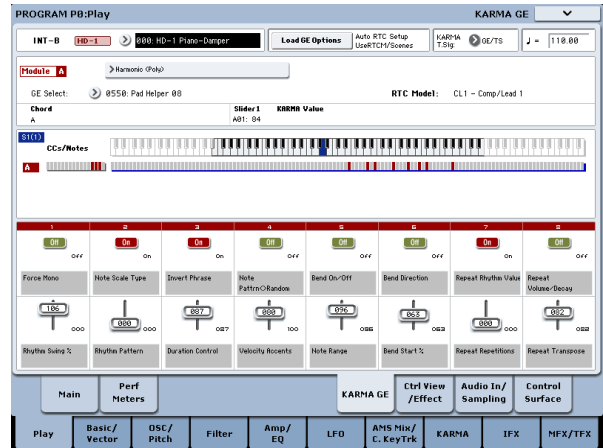

The lower part of the display shows the names of the sliders and switches that are assigned in this program. In the pre-loaded programs, the KARMA CONTROLS sliders and KARMA SWITCHES have already been assigned.

2. Operate the front panel KARMA CONTROLS 1–8 sliders and KARMA SWITCHES 1–8.

The pattern or phrase will change accordingly.

You can also turn the switches on/off by pressing them in the display. You can operate the sliders by selecting them and then using the VALUE controller to adjust the value.

The type or value of the parameter being controlled by the sliders and switches is shown in the KARMA Module Info “KARMA Value” field. This lets you see how the parameters are being affected by your slider or switch operations.



The saved value is shown at the lower right of each slider or switch.

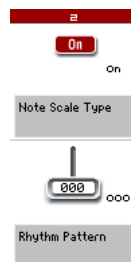

**3. Use the front panel SCENE 1–8 switches to choose a scene.**

The sliders and switches will change to the settings that were saved in the scene you chose.

Each of the eight scenes contains the values of sliders 1–8 and switches 1–8. By pressing a SCENE 1–8 switch to choose a scene, you can instantly recall settings for the eight sliders and eight switches.

Even if you switch scenes, the changes you make using sliders 1–8 and switches 1–8 are remembered until you select another program. When you write a program, your slider and switch settings are saved in the respective scene 1–8.

**Restoring the state of the sliders and switches**

You can do this by adjusting the controls while you watch the sliders and switches in the screen, or you can use the following method.

Restoring the entire program

**1. Press the COMPARE switch.**

The entire program will revert to the state in which it was written. (See “Using COMPARE” on page 46.)

**2. Press the COMPARE switch once again.**

The program will return to the edited state.

Restoring all sliders and switches of the selected scene

**1. Operate the sliders and switches to edit the values saved in the program.**

The LED of the selected SCENE switch will blink.

**2. Hold down the RESET CONTROLS switch, and press the SCENE switch.**

All sliders and switches will be reset to their stored settings, and the SCENE switch LED will light.

**3. Once again, hold down the RESET CONTROLS switch and press the SCENE switch.**

All sliders and switches will return to the edited state of step 1, and the SCENE switch LED will blink.

Restoring a single slider or switch

**1. Operate the sliders and switches to edit the values saved in the program.**

**2. Hold down the RESET CONTROLS switch, and operate the slider or switch that you want to restore.**

The selected slider or switch will return to its stored setting.

Restoring all scene settings

**1. In each scene, operate the sliders and switches to edit the values saved in the program.**

**2. Hold down the RESET CONTROLS switch, and press the MODULE CONTROL switch.**

All scenes will return to their stored settings.

**⚠** If you’ve used the RESET CONTROLS switch to return all scenes to their original setting, there is no way to return to the edited settings of step 1.

Resetting the REALTIME CONTROL knob settings for all scenes

**1. Use the REALTIME CONTROL knobs to edit the sound of the program, and use the sliders and switches to modify the saved settings in each scene.**

**2. Hold down the RESET CONTROLS switch, and press the CONTROL ASSIGN RT KNOBS/KARMA switch.**

The Real-Time Controls knob settings will be reset (to the center value of 064), and the settings of all scenes will return to their stored settings.

**⚠** If you’ve used the RESET CONTROLS switch to reset the Real-Time Controls knobs and to return all scenes to their saved setting, there is no way to return to the edited settings of step 1.

**Selecting a GE (Generated Effect)**

When KARMA is on, the KARMA module uses a GE to generate phrases or patterns. The KRONOS provides a wide range of GEs that you can use for a variety of instruments, playing techniques, and musical styles (See “The structure of KARMA” on page 225).

For each of the pre-loaded programs, a GE that’s appropriate for the sound of the program is already selected. If you switch to a different GE, the generated phrase or pattern will change dramatically.

**1. Go to the Program P0: Play– KARMA GE page.**

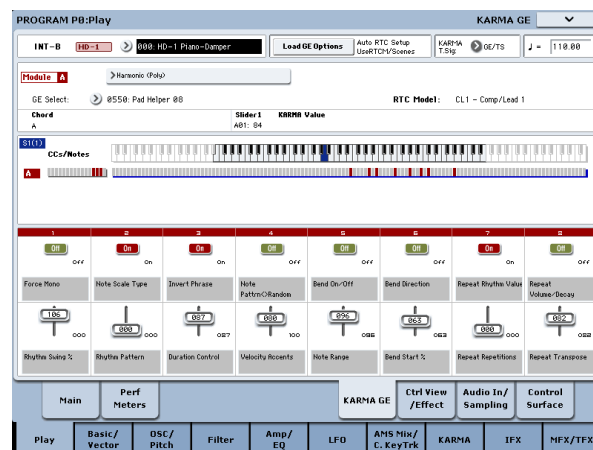

**2. In the display, press the “GE Select” popup button to open the “GE Select” menu.**

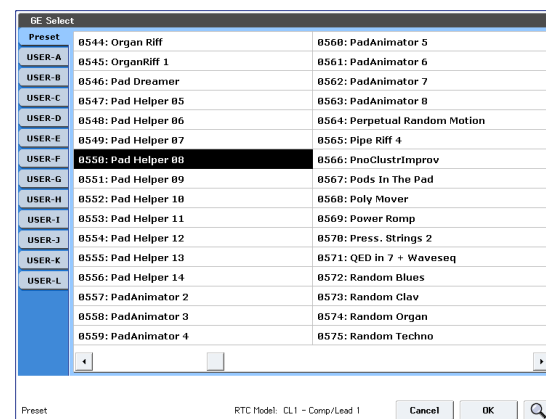

**3. Select a GE from the list in the right side of the display.**

The selected GE will be highlighted and will become active. If you now play the keyboard, this GE will generate a phrase or pattern.

While this menu is displayed, you can select and play these GEs without pressing the OK button.

- If you are satisfied with the program you selected, press the OK button to close the menu.

Alternatively, you can select a GE by choosing “GE Select” in the display, and operating the VALUE slider or VALUE dial. You can also use “GE Category Select” to choose a GE by category. (See “GE Category Select” on page 10 of the Parameter Guide.)

### Editing KARMA module parameters

For details on editing the parameters of a KARMA module, see “Editing KARMA” on page 235.

## Performing with KARMA in Combination mode

In Combination mode, up to four KARMA modules can be operating simultaneously. You can use the four KARMA modules together with the sixteen timbre programs in a wide variety of ways, for example by using them to independently play phrases and patterns for separate programs such as drums, bass, guitar, and strings.

### Selecting a Combination and turning KARMA on/off

- Press the COMBI switch to enter Combination mode, and select the desired combination. (See “Selecting Combinations” on page 63.)

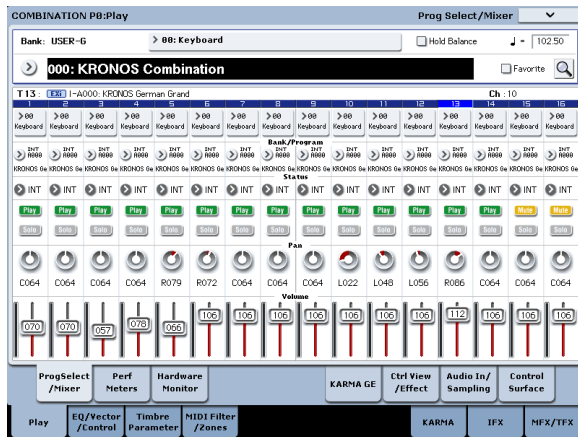

As you step through the combinations, you will notice that the KARMA ON/OFF switch LED is lit for some combinations.

With these combinations, KARMA will begin playing when you play the keyboard.

Note: If the Drum Track is on, and Trigger Mode is set to Wait KBD Trig, the Drum Track will start playing simultaneously.

Even for other combinations, you can press the KARMA ON/OFF switch (LED lit) to turn on KARMA.

### Adjusting the performance tempo

In the same way as for a program, you can use the TEMPO knob or the TAP TEMPO switch to adjust the performance tempo. Changing the tempo will affect the tempo of all KARMA modules that are operating. (See p.229)

- You can't adjust the performance tempo of each KARMA module individually.

### Checking note-on/off and key zone

The screen shown below is a realtime display of the note data received from the keyboard, pads 1–8, and MIDI IN, and the note on/off data generated by KARMA modules A, B, C, and D, together with the name of the chord that was detected.

- Go to the Combination P0: Play– KARMA GE page.

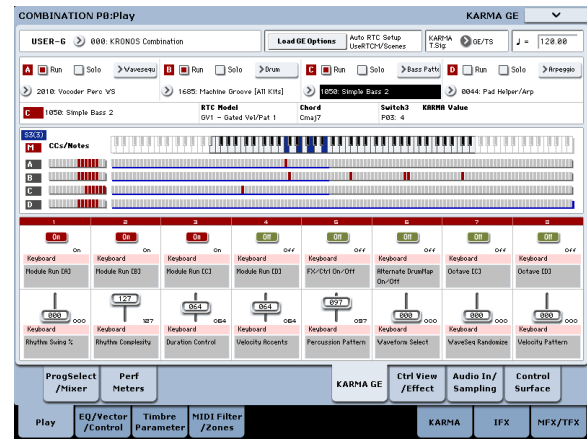

When you play the keyboard, the name of the chord detected by each KARMA module will appear in the “Chord” field of KARMA Module Info.

The displayed chord name is the chord that is detected by the module selected by the front panel MODULE CONTROL switch. The way in which chords are detected will depend on the settings of the KARMA module.



The CCs/Notes area shows the status of the control data and note-on/off data generated by KARMA modules A, B, C, and D, and the key zone settings of the KARMA modules.

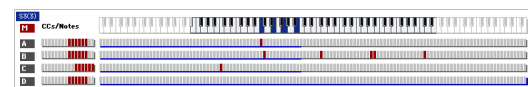

Note: Chord detection is affected by the KARMA module's key zone settings (Combination 7–1b), “Transpose” (Combination 7–3b: Module Parameter-Control), and Dynamic MIDI “Destination” (Combination 7–8) Chord Scan and Smart Scan.

## Using the KARMA controllers

You can operate the KARMA controllers to control the phrase or pattern generated by each KARMA module. In Combination mode, you can choose the KARMA module that you want to control.

**Note:** The state of the KARMA controllers is saved when you write the combination.

### 1. Go to the Combination P0: Play– KARMA GE page.

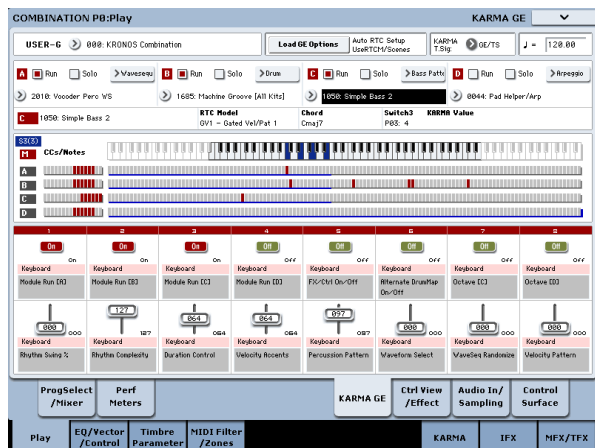

The lower part of the display shows the names of the sliders and switches that are assigned in this combination.

In the pre-loaded combinations, the KARMA CONTROLS sliders and KARMA SWITCHES have already been assigned.

### 2. Use the front panel MODULE CONTROL switch to select the module that you want to control.

If you select MASTER, you will be controlling all four KARMA modules simultaneously.

If you select A–D, you will be controlling the corresponding KARMA module.

### 3. Operate the front panel KARMA CONTROLS 1–8 sliders and KARMA SWITCHES 1–8.

The sliders and switches will control the pattern or phrase generated by the KARMA module selected by the MODULE CONTROL switch. If you’ve selected MASTER, you’ll be able to control the module on/off status and vary the patterns and phrases generated by all of the KARMA modules.

You can also operate the sliders and switches in the display or using the VALUE controller, just as in Program mode.

The KARMA module and the type or value of the parameter being controlled by the sliders and switches is shown in the KARMA Module Info “KARMA Value” field. This lets you see the KARMA module and parameters that are being affected by your slider or switch operations.

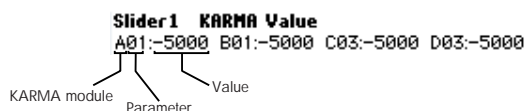

### 4. Use the front panel SCENE 1–8 switches to choose a scene.

This changes the scene for the KARMA module(s) selected by the MODULE CONTROL switch.

If MODULE CONTROL is set to MASTER, each KARMA module will change to the scene that is saved as the master setting.

Each of the eight scenes contains the values of sliders 1–8 and switches 1–8. By pressing a SCENE 1–8 switch to choose a scene, you can instantly recall settings for the eight sliders and eight switches.

Even if you switch scenes, the changes you make using sliders 1–8 and switches 1–8 are remembered until you select another combination. When you write a combination, your slider and switch settings are saved in the respective scene 1–8.

### Name display for the KARMA CONTROLS 1–8 sliders and KARMA SWITCHES 1–8

Just as in the equivalent page of Program mode, the Combination P0: Play– KARMA GE page displays the sliders and switches assigned to the combination, and their names.

In the combination, the name shown in square brackets [ ] is the category of the program selected for the timbre being controlled by the KARMA CONTROLS 1–8 sliders and KARMA SWITCHES. This tells you the timbre whose phrase is being controlled by the KARMA CONTROLS 1–8 sliders and KARMA SWITCHES.

If multiple timbres are being controlled simultaneously, this will indicate [MLTI].

## KARMA module “Run” and “Solo” settings

In Combination mode, up to four KARMA modules can be operating simultaneously.

If KARMA is off, all KARMA modules will be stopped. If KARMA is on, the KARMA module(s) you specify here will operate.

### 1. Go to the Combination P7: KARMA– GE Setup/Key Zones page.

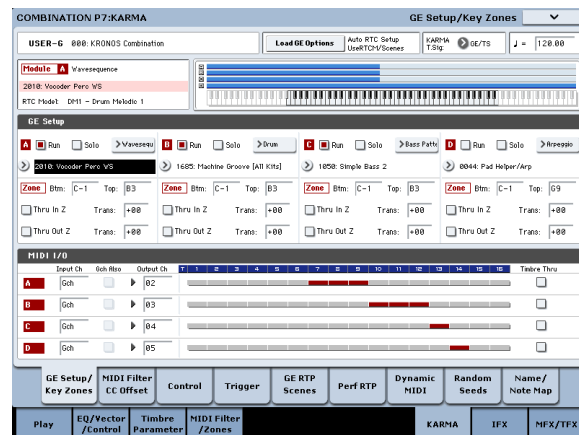

### 2. Use the “Run” and “Solo” settings to specify the module(s) that will operate when KARMA is on.

KARMA modules whose “Run” setting is On (checked) will operate.

If you turn “Solo” On (checked), only that KARMA module will sound. This is useful when you are selecting a GE, or when you want to audition the phrase that a module is generating.

Modules whose “Solo” is On (checked) will sound even if “Run” is Off (unchecked).

- 🔊 The “Solo” setting is cleared when you switch to another combination. It is not saved when you write the combination.

KARMA module A will sound.



KARMA module B will sound.



KARMA modules A and B will sound.



*Note:* If “  Run ” is not shown in the display, “Run” has been assigned as a performance realtime performance. The KARMA SWITCHES etc. will control “RUN.”

---

### KARMA module MIDI I/O channel settings

The MIDI input/output channel setting for each KARMA module and the MIDI channel setting of each timbre together determine how the KARMA modules will play the timbres.

If a KARMA module’s MIDI output channel matches the MIDI channel of a timbre, the phrase or pattern generated by that KARMA module (if it’s operating) will play that timbre. For details on making these settings, see “Editing KARMA in Combination mode” on page 239 and “7-1c: MIDI I/O” on page 475 of the Parameter Guide.

---

### GE (Generated Effect) selection

Just as for a program, you can use the “GE Select” field to select the GE used by each module. (See “Editing KARMA in Combination mode” on page 239)

### KARMA module parameter settings

For details on editing KARMA module parameters, see “Editing KARMA in Combination mode” on page 239.



## Editing KARMA

This section explains how to make settings for KARMA in each mode. For details on how to perform using KARMA, see “Performing with KARMA” on page 229.

## Editing KARMA in Program mode

In Program mode you can use only one KARMA module (module A). KARMA settings for a program are made in the various pages of Program P7: KARMA. Here we will explain how to use the major parameters, such as selecting a GE. For other parameters, see “Program P7: KARMA” on page 106 of the Parameter Guide.

### Switching KARMA on/off

Each time you press the KARMA ON/OFF switch, KARMA will be turned on or off. When on, the switch LED will be lit. The on/off status is saved when you write the program.

### Selecting a GE

Here’s how to select the GE used by the KARMA module.

#### 1. Go to the Program P7: KARMA– GE Setup/Key Zones page.

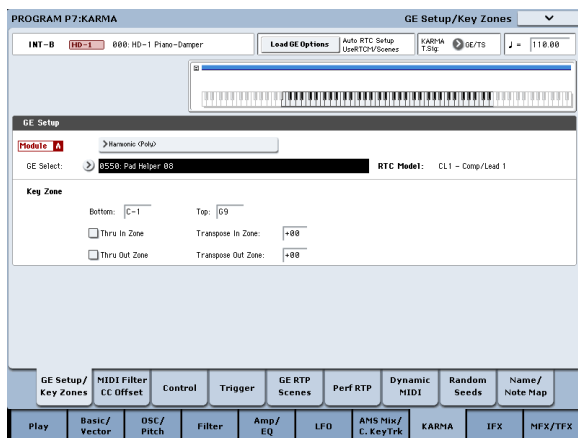

#### 2. Press “Load GE Options” to open the dialog box, turn Auto RTC Setup on, and check the User RTC Model and Reset Scenes options.

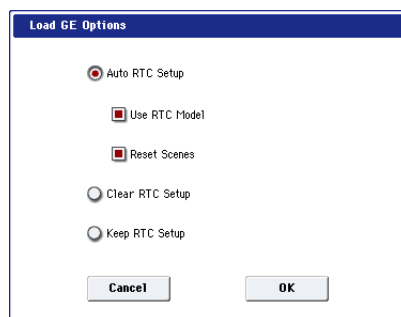

“Load GE Options” specifies whether the settings of the KARMA CONTROLS sliders and KARMA SWITCHES settings will be automatically set, initialized, or maintained when you select a GE.

In this example, we’ve opted to automatically set the slider and switch functions to the standard settings for the RTC Model of the selected GE, so that you’ll be able to control the phrase or pattern immediately.

#### 3. Use “GE Select” to select the GE used by the KARMA module.

Use “Tempo” to set the tempo of the pattern or phrase generated by the GE.

Use “KARMA T.Sig” to specify the time signature of the pattern or phrase generated by the GE. If you select GE/TS the time signature specified by the GE will be used; with any other setting, the time signature will change temporarily.

The KRONOS provides numerous preset GEs that can be used for a wide range of instruments, playing techniques, and musical styles.

“Category Select” shows the category of the GE that’s selected for the KARMA module. All GEs are organized by category. You can press “Category Select” to open the Category/GE Select screen, and choose a GE by category and sub-category (see “GE Category Select” on page 10 of the Parameter Guide).

## Copying KARMA settings from another Program

You can use the “Copy KARMA Module” page menu command to copy KARMA settings (EG selection, KARMA module parameter settings, etc.) from another program.

#### 1. Press the page menu button to open the page menu, and choose “Copy KARMA Module.”

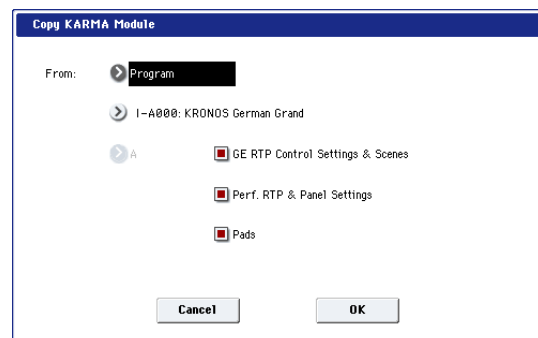

#### 2. Specify the copy-source mode, bank, and number.

If you want to copy the GE realtime parameter settings and scene settings from the copy-source program, choose the “GE RTP Control Settings & Scenes” option (checked).

If you want to copy performance realtime parameters settings and front panel settings from the copy-source program, choose the “Perf. RTP & Panel Settings” option (checked).

If you to copy the pad settings from the copy-source program, choose the “Pads” option (checked).

3. Press OK to execute the copy, or press Cancel if you decide to cancel.

### Setting KARMA's keyboard zone

Here's how to specify the zone of keys that will trigger KARMA. For example you might make settings so that the keys at the bottom of the keyboard will trigger phrases, and keys above this range can be played normally.

1. Go to the Program P7: KARMA– GE Setup/Key Zones page. (See the diagram in step 1 of “Selecting a GE”)
2. Use the Key Zones Bottom and Top to specify the key zone.

Any notes that fall within this range—including both playing on the local keyboard and notes received from MIDI IN—will be sent to the KARMA module.

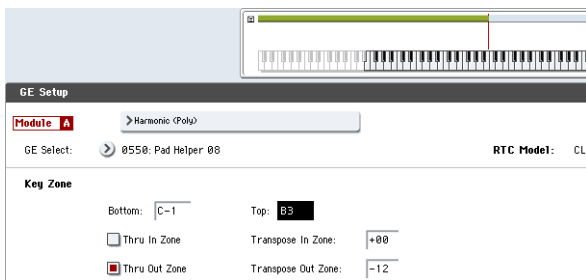

In the example shown above, the notes from C-1 through B3 are being input to the KARMA module. When you play B3 or a lower note, KARMA will generate a phrase or pattern.

3. If “Thru In Zone” and “Thru Out Zone” are on (checked), the notes you play on the keyboard will play in addition to the phrase or pattern generated by KARMA.

These two fields are the settings for inside and outside the key zone.

You can use “Transpose In Zone” and “Transpose Out Zone” to transpose the notes played on the keyboard in semitone steps.

In the example shown above, the B3 and lower keys will control only the phrase or pattern generated by KARMA, and the C4 and higher keys will be used for manual playing on the keyboard. Use “Transpose Out Zone” to adjust the pitch of the manually-played region.

### KARMA module MIDI filtering and CC offset

1. Go to the Program P7: KARMA– MIDI Filter/CC Offset page.

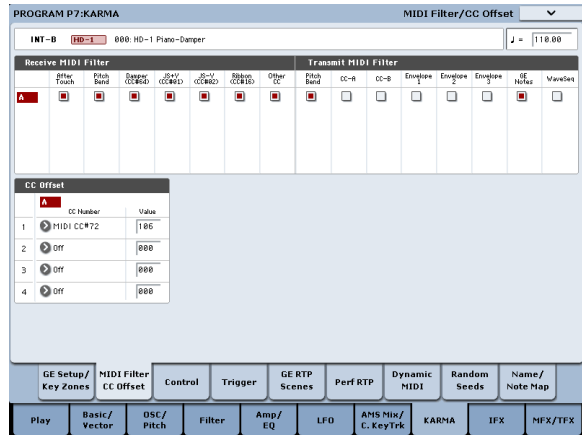

#### Receive MIDI Filter

This specifies whether filtering will be applied to the MIDI control data received by the KARMA module. If an item is on (checked), the corresponding data will be received.

When KARMA is on, MIDI control data received by the KARMA module is sent directly to the tone generator. If this setting is off (unchecked), that data will not be sent to the tone generator.

In the example shown above, damper pedal messages are enabled when KARMA is off, and disabled when it is on.

#### Transmit MIDI filter

This specifies whether filtering will be applied to the MIDI control data generated by the GE selected for the KARMA module. If an item is on (checked), transmission is enabled.

Normally you will leave these items on. If you don't want to use the pitch bend or other control change data generated by the selected GE, turn these items off (unchecked).

In the example shown above, pitch bend data generated by the GE will not be transmitted.

#### CC Offset

Use this if you want to control the effects or the sound of the program while KARMA is on. For example, you might use this to decrease the brightness of the sound or raise the resonance of the sound in conjunction with the phrase that's being generated. Alternatively, you might use this to control effects, for example by turning on a delay effect in conjunction with a generated phrase.

Use “CC Number” to specify the MIDI control change number. Choose one of the CC numbers in the 70's which control the sound, or an AMS or Dmod source (see “7-2c: CC Offset” on page 110 of the Parameter Guide).

In the example shown in the preceding page, CC#74 and CC#71 are controlling filter cutoff and resonance level.

#### KARMA module parameters

In the Program P7: KARMA– Module Parameters-Control and Trigger pages you can edit KARMA module parameters.



Here we will describe how to edit the most frequently-used parameters. For details on the other parameters, refer to “7–3a: Program Name and Tempo” on page 111 of the Parameter Guide.

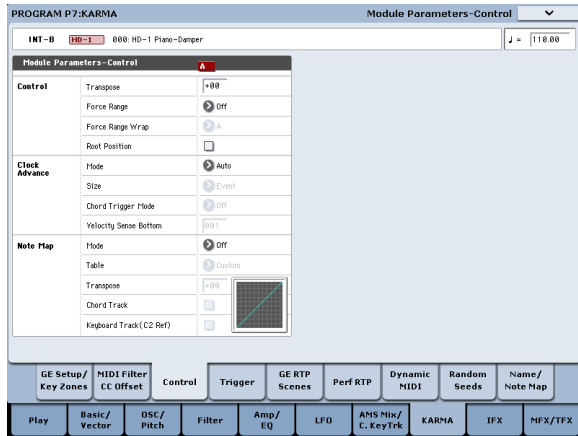

### Control – Transpose

This lets you transpose the note data being input to the KARMA module in semitone steps. This will control the pitch of the phrase or pattern generated by the KARMA module. For example if you want to lower a bass phrase by one octave, set this to –12.

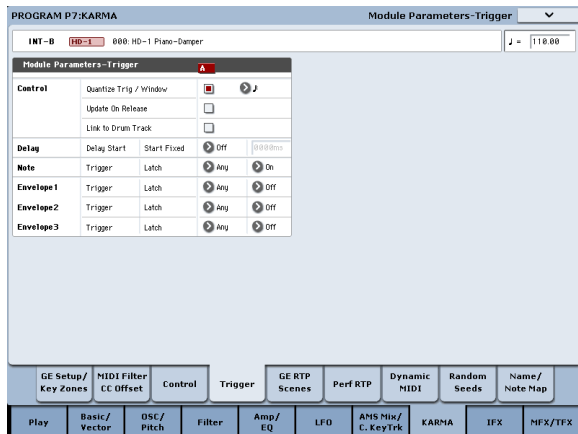

### Control – Quantize Trig (Quantize Triggers)

This quantizes the timing of the triggering produced by the note data. (See “Synchronizing KARMA” on page 247)

**Off (unchecked):** Triggering will occur the moment you play the key.

**On (checked):** Trigger timing will be quantized to the selected note interval relative to the base tempo.

### Note – Trigger

This specifies the triggering conditions for the phrase or pattern generated by the GE. Try these out and see how they differ.

**Any:** Triggering will occur each time you play a key, and the phrase or pattern will play from the beginning.

**AKR:** Triggering will occur only the first time you play a key after having released all notes on the keyboard.

**1st:** Triggering will occur only at the first note you play after turning on KARMA.

**Dyn:** Playing the keyboard will not cause triggering. Triggering will occur when you operate the controller specified by Dynamic MIDI.

### GE Real-Time Parameters

Here you can edit the GE realtime parameters that are selected by the KARMA module. You can also assign GE realtime parameters to the KARMA CONTROLS sliders and KARMA SWITCHES so that you can use them to control the phrase or pattern in realtime while you perform.

**Note:** If you use the Auto RTC Setup function of “Load GE Options,” the standard slider and KARMA SWITCH assignments for the RTC Model of that GE will automatically be made when you select a GE. (See “Selecting a GE” on page 235)

#### 1. Go to the Program P7: KARMA– GE Real-Time Parameters page.

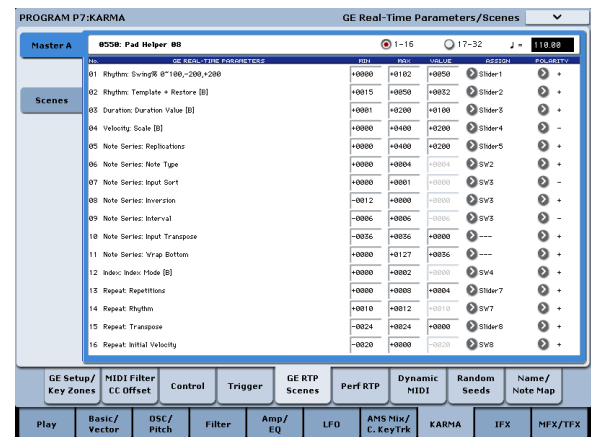

Use “GE RTC Select” to switch the set of GE realtime parameters you want to see.

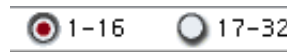

These buttons display GE realtime parameters 1–16 or 17–32.

The number and type of GE realtime parameters you can edit here will differ depending on the selected GE. (There will be a maximum of 32.) In each GE, the parameters most useful for controlling the phrase or pattern are provided as presets.

**Note: RTC Model:** Every GE contains an internal setting that indicates its RTC Model. Based on the type or purpose of the GE, the RTC Model provides a certain degree of standardization to the over 200 internal parameters of the GE. By default, GEs that have the same RTC Model will be preset with the same GE realtime parameters.

#### 2. Use “VALUE,” “MIN,” and “MAX” to specify the value, minimum value, and maximum value of each GE realtime parameter.

When you select a GE, the default parameter values that are preset for that GE will be assigned.

The values you assign here are controlled as follows by the KARMA CONTROLS you specify in the “ASSIGN” field.

Slider 1–8	000-064-127 =MIN-VALUE-MAX
Slider 1–8 (SW)	000-063 = MIN, 064-127 = MAX
SW 1–8	Off = MIN, On = MAX
DynaMIDI 1–8	Depending on Dynamic MIDI setting

#### 3. Use “ASSIGN” to assign each GE realtime parameter to the desired controller.

#### 4. Use Polarity to specify the polarity of control.

+ : Control the parameter as shown in the table above.

– : The relationship of MIN and MAX will be inverted. For example as you move a slider from 000 to 127, the value will be controlled from the MAX value to the MIN value.

**Perf RTP (Perf Real-Time Parameters)**

Here’s how KARMA parameters such as KARMA key zone and KARMA module parameters (i.e., KARMA parameters other than GE realtime parameters) can be assigned to controllers.

If you’ve assigned these parameters to KARMA CONTROLS, you’ll be able to control them in realtime while you perform (see “Control Surface knobs, sliders, & switches” on page 37, and “7–6b: Perf Real-Time Parameters” on page 122 of the Parameter Guide).

**1. Go to the Program P7: Perf Real-Time Parameters page.**

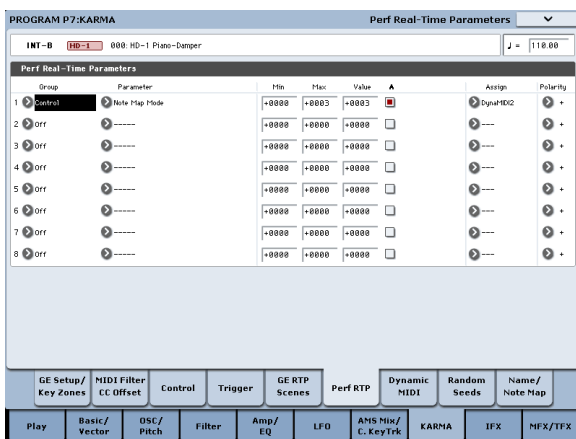

As an example, we’ll show how you can use a KARMA CONTROLS slider to control the KARMA module parameter “Transpose.”

**2. Use “Group” and “Parameter” to select the parameter you want to control.**

For this example, set “Group”: Mix, and “Parameter”: Transpose. Turn “A” on (checked) so that the slider will control KARMA module [A].

**3. Specify the range and value that you want to control.**

The setting of the parameter will be assigned by default (–12 in this example), as described under “7–3b: Module Parameter-Control” on page 111 of the Parameter Guide.

For this example, set “Min,” “Max,” and “Value” to –24, +0, and –12 respectively.

**4. Use “Assign” to assign the desired controller.**

For this example, we’ll assign Slider 1.

**5. Use Polarity to specify the polarity of control.**

For this example, specify “+”.

When you set CONTROL ASSIGN to RT KNOBS/KARMA and operate slider 1, the Transpose setting will change in semitone steps over a range of –24 to +0, with –12 as the center value.

**Note:** If you set “Parameter” to Transpose Octave, the change will occur in steps of one octave over a range of –24 to +0, with –12 as the center value.

If you select Transpose Octave/5th, the change will occur in alternating steps of an octave or a fifth, over a range of –24 to +0 with –12 as the center value. For example if this

parameter is at the Min setting and a C3 note is sounding, moving slider 1 from 000 toward 127 will cause a pitch change of C3 → G3 → C4 → G4 → C5.

**Dynamic MIDI setting**

Dynamic MIDI lets you use a KRONOS controller or a MIDI control message to control a specific parameter of KARMA. You can specify up to eight controllers (Source) and what they will do (Destination). For more information, see “Dynamic MIDI Sources & Destinations” on page 1114 of the Parameter Guide.

**Naming the KARMA RTC sliders 1–8 and switches 1–8**

**1. Go to the Program P7: KARMA– Name/Note Map page.**

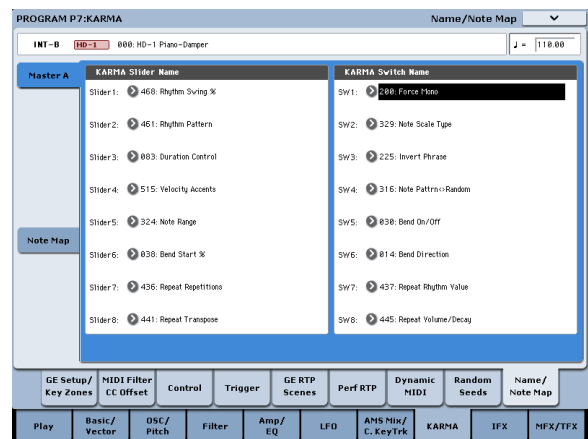

Here you can select names for the KARMA CONTROLS sliders and KARMA SWITCHES. You can save these settings independently for each program. The KRONOS provides suitable preset names for the KARMA CONTROLS sliders and KARMA SWITCHES.

**Auto Assign KARMA RTC Name**

An appropriate name for each KARMA CONTROLS slider and KARMA SWITCH will be determined based on the GE RTP or Perf RTP being controlled, and will be assigned automatically. (See “Auto Assign KARMA RTC Name” on page 149 of the Parameter Guide.)

**Linking KARMA settings to Program changes**

KARMA settings can be saved individually for each Program. Normally, when you select a new Program, its KARMA settings will be loaded as well. In some cases, however, you may wish to try out different Programs while keeping the KARMA settings the same.

The Global Basic page **Load KARMA Settings when changing** parameters let you select between these two behaviors. There are separate settings for Programs, Combis, and Songs. To set this up:

1. Go to the Global Basic page.
2. Under “Load KARMA setting when changing”, set the “Programs” check-box as desired.

Check the box to load the individual Programs’ KARMA settings.

Un-check the box to keep KARMA settings the same, even when changing Programs.

For more information, see “Load KARMA settings when changing” on page 755 of the Parameter Guide.

## Editing KARMA in Combination mode

In Combination mode (and Sequencer mode) you can use four KARMA modules (modules A, B, C, and D). In a combination, you can use the four KARMA modules and the sixteen timbre programs in a variety of ways; for example, separate phrases or patterns can play programs such as drums, bass, guitar, and strings.

KARMA settings for a combination are made in the various pages of Combination P7: KARMA. Here we will explain the procedure for setting the major parameters, such as “Run” and “Solo” settings, the selection of a GE, and MIDI I/O settings. For other parameters, see “Editing the parameters of each KARMA module” on page 241. and “7–1b: GE Setup/Key Zones” on page 475 of the Parameter Guide.

### Switching KARMA on/off

Each time you press the KARMA ON/OFF switch, KARMA will be turned on or off. When on, the switch LED will be lit. This on/off status is saved when you write the Combination.

When KARMA is off, all KARMA modules A, B, C, and D will be off. When KARMA is on, the KARMA modules will operate as specified by their “Run” and “Solo” settings.

### “Run” and “Solo” settings

1. Go to the Combination P7: KARMA– GE Setup/Key Zones page.

**Note:** Alternatively, you can make these settings in the Combination P0: Play– KARMA GE page.

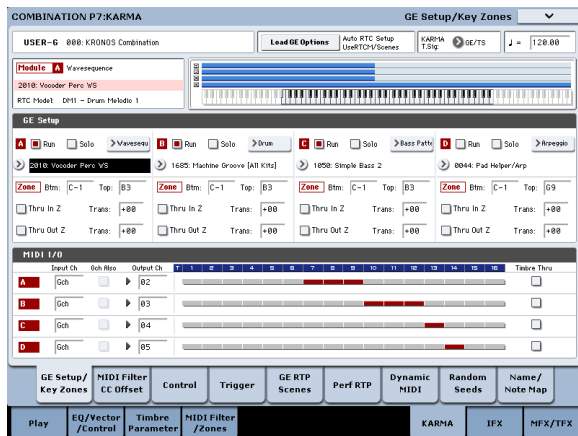

2. Use “Run” and “Solo” to select the module(s) that will operate when KARMA is on.

For more information, see “0–6b: GE Select” on page 426 of the Parameter Guide.

**Note:** For the preloaded combinations, when the MODULE CONTROL switch is set to MASTER, KARMA SWITCHES 1, 2, 3, and 4 will switch “Run” on/off for modules A, B, C, and D.

### Selecting a GE

Here’s how to select the GE used by each KARMA module. (See “Editing KARMA in Program mode” on page 235)

1. Go to the Combination P7: KARMA– GE Setup/Key Zones page.

**Note:** Alternatively, you can make these settings in the Combination P0: Play– KARMA GE page.

2. Press “Load GE Options” to open the dialog box, turn Auto RTC Setup on, and check the User RTC Model and Reset Scenes options.

“Load GE Options” specifies whether the settings of the KARMA CONTROLS sliders and KARMA SWITCHES will be automatically set, initialized, or maintained when you select a GE.

For this example, we’ll choose to set the slider and switch functions for KARMA modules A, B, C, and D to the standard settings for the RTC Model of the selected GE, so that you’ll be able to control the phrase or pattern immediately.

3. Use “GE Select” to select the GE used by the KARMA module.

Use “Tempo” to set the tempo of the pattern or phrase generated by the GE.

Use “KARMA T.Sig” to specify the time signature of the pattern or phrase generated by the GE. If you select GE/TS the time signature specified by the GE for each module will be used; with any other setting, the time signature of all GEs will change temporarily.

### MIDI I/O channel settings

You can specify the MIDI input and output channels for each of the four KARMA modules used by a combination.

The MIDI input/output channel setting for each KARMA module and the MIDI channel setting for each timbre will determine the routing that specifies how the KARMA modules play the timbres. These are the most important settings when using multiple KARMA modules in a combination.

1. Go to the Combination P7: KARMA– GE Setup/Key Zones page.
2. Specify the “Input Channel” and “Output Channel” of each KARMA module.

**“Input Channel”:** For a combination, you will normally set this to Gch so that your keyboard playing will control the KARMA module.

**“Output Channel”:** Set this to the MIDI channel of the timbre(s) that should be played by this KARMA module.

**Gch Also:** This option is available if Input Channel is set to other than Gch. If you select (check) this option, a module that would normally be triggered only by the Input Channel will also be triggered by the Gch. (Gch, Global 1–1a)

**Timbre Thru:** If this option is on (checked), timbres differing from the global MIDI channel will sound when KARMA is off.

#### Setting example 1

This example shows how the “Gch Also” option works.

1. Set MIDI Channel for the following timbres as follows.

Timbre 1: G ch

Timbre 2: 2 ch

Timbre 3: 3 ch

Timbre 4: 4 ch

Timbre 5: 5 ch

**2. Set the MIDI channels for the pads as follows.**

Pad 1: MIDI channel = 2 ch

Pad 2: MIDI channel = 3 ch

Pad 3: MIDI channel = 4 ch

Pad 4: MIDI channel = 5 ch

**3. For each KARMA module, set “Input Channel” and “Output Channel” as follows.**

KARMA module A: “Input Ch” = 2 ch, “Out Ch”= 2 ch

KARMA module B: “Input Ch” = 3 ch, “Out Ch”= 3 ch

KARMA module C: “Input Ch” = 4 ch, “Out Ch”= 4 ch

KARMA module D: “Input Ch” = 5 ch, “Out Ch”= 5 ch

**4. Turn KARMA off.**

When you play the keyboard, timbre 1 will sound.

When you strike pads 1–4, timbres 2–5 will sound.

**5. Turn KARMA on.**

When you play the keyboard, timbre 1 will sound.

When you strike pads 1–4, KARMA modules A–D will each trigger a different GE which will play phrases or patterns on timbres 2–5.

**6. For KARMA module A, turn “Gch Also” on (checked).**

**7. Turn off KARMA.**

When you play the keyboard, timbre 1 will sound.

When you strike pads 1–4, timbres 2–5 will sound.

**8. Turn on KARMA.**

When you play the keyboard, timbre 1 will sound. KARMA module A for which you turned “Gch Also” on (checked) will trigger its GE and play a phrase or pattern on timbre 2.

When you strike pads 1–4, KARMA modules A–D will trigger their respective GEs and play phrases or patterns on timbres 2–5.

**Setting example 2**

This example shows how the “Timbre Thru” option works.

Select a piano program for timbre 1, a bass program for timbre 2, and a drum program for timbre 3.

We’ll play timbre 1 manually from the keyboard. KARMA module A will be used to play a bass phrase on timbre 2, and KARMA module B to play a drum phrase on KARMA module B. (Make sure that the global MIDI channel is 01.)

**1. Set the MIDI Channel for timbres 1, 2, and 3.**

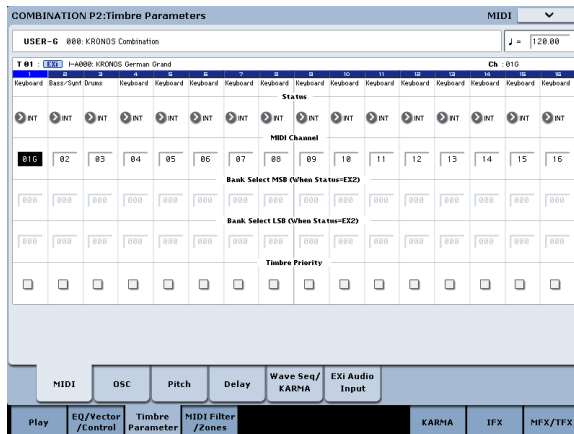

For this example, set timbre 1 to 01, timbre 2 to 02, and timbre 3 to 03. Since each timbre is set to a separate channel, the KARMA module set to the corresponding channel will play only that timbre.

**2. Set the “Input Channel” and “Output Channel” of each KARMA module as follows.**

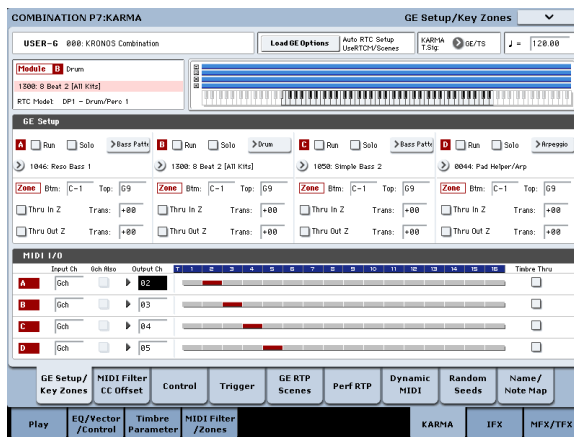

KARMA module A: “Input Ch” = G ch, “Out Ch”= 02

KARMA module B: “Input Ch” = G ch, “Out Ch”= 03

The timbres played by the KARMA modules are shown in red, as specified by the timbre’s MIDI channel setting and the KARMA module’s Out Channel setting.

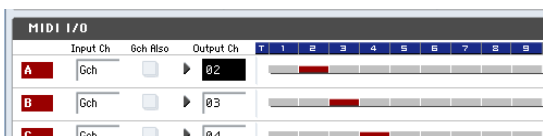

**3. For KARMA modules A and B, turn “Run” on (checked), and set “GE Select” to GE. (See ““Run” and “Solo” settings” on page 239.)**

KARMA module A: select a bass phrase as the GE

KARMA module B: select a drum phrase as the GE

When KARMA is on, your playing on the keyboard will sound a piano on timbre 1, and will simultaneously be sent to KARMA modules A and B.

The bass phrase generated by module A is sent on MIDI channel 02 to play timbre 2.

The drum phrase generated by module B is sent on MIDI channel 03 to play timbre 3.

**4. Use “Timbre Thru” to specify what will sound when KARMA is off.**

When KARMA is off, playing the keyboard will normally sound only the timbres that match the global MIDI channel (Ch 01).

In this example, this will be the piano sound produced by timbre 1 (Ch 01).

If “Timbre Thru” is on (checked), you’ll be able to play timbres that differ from the global channel when KARMA is off.

For KARMA module A, turn “Timbre Thru” on (checked). When KARMA is off, playing the keyboard will sound the piano of timbre 1 (Ch 01) as well as the bass of timbre 2 (Ch 02).

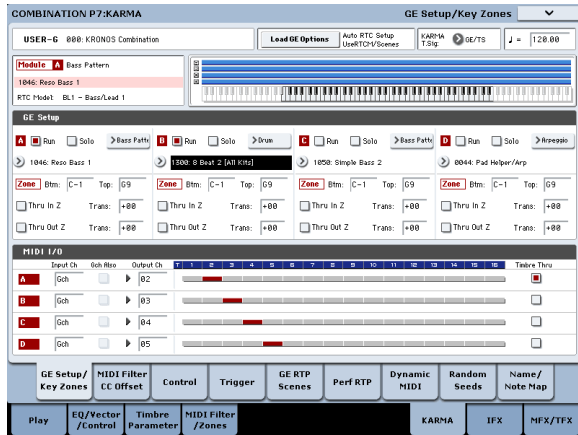

**Editing the parameters of each KARMA module**

You can specify the keyboard zone in which each KARMA module operates, make MIDI filter settings, and edit KARMA module parameters. Just as for a program, these parameters can be specified independently for each KARMA module.

**GE Real-Time Parameters**

Here’s how to edit the parameters of the GE selected for each KARMA module.

**1. Go to the Combination P7: KARMA– GE Real-Time Parameters page.**

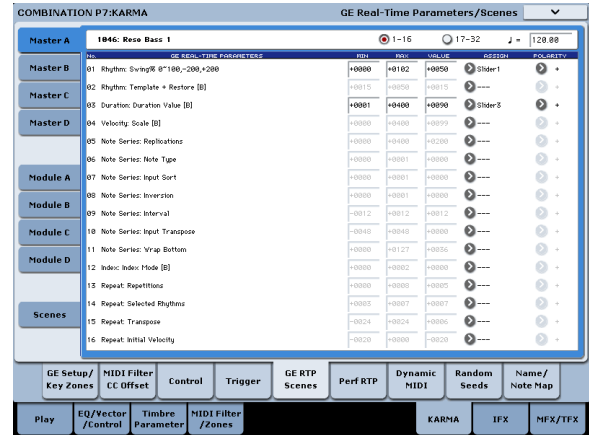

**2. In the tabs at the left, select Master A.**

**3. Set “MIN,” “MAX,” “VALUE,” “ASSIGN,” and “POLARITY.”**

In the Master tabs, specifying “ASSIGN” lets you edit the “MIN,” “MAX,” “VALUE,” and “Polarity” settings.

**4. Make settings in the same way for Master B, C, and D.**

The settings you make here are used when MODULE CONTROL is set to MASTER.

Master lets you control any parameters of modules A, B, C, or D. You can also use a single controller to simultaneously control multiple parameters in different modules; for example, you might use Slider 1 to control the “Rhythm: Swing%” parameter of modules A, B, C, and D.

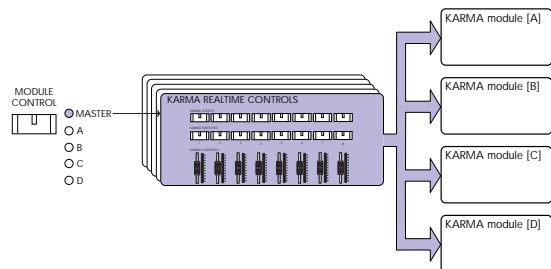

**5. In the tabs at the left, select Module A.**

**6. Set “MIN,” “MAX,” “VALUE,” “ASSIGN,” and “POLARITY.”**

**7. Make settings in the same way for Module B, C, and D.**

The “ASSIGN” settings for module A, B, C, and D are used when MODULE CONTROL is set to A, B, C, or D respectively.



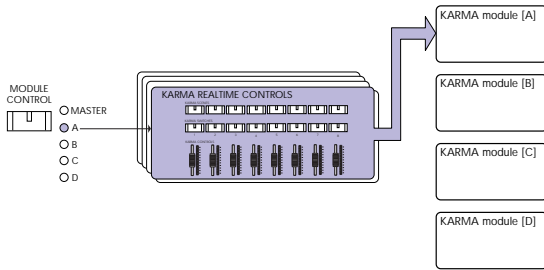

With the appropriate “ASSIGN” settings, a GE realtime parameter of (for example) module A can be controlled independently by Master and Module A. For example you can make settings so that the Swing parameter of a drum GE on module A is controlled in MASTER by slider 1 over a range of 0–50%, and in MODULE A by slider 1 over a range of 50–100%.

Master: 0–50%  
Module A: 50–100%

In this case, if you switch MODULE CONTROL between MASTER and A while using slider 1 to control the parameter, the parameter will operate in its last-controlled state. If you set Swing to 0% in MASTER, and then switch to module A, Swing will remain at 0% as long as you don’t move slider 1. However Swing will change once you move slider 1 to control the parameter in the range of 50–100%.

1. Set MODULE CONTROL to MASTER, and set slider 1 to the minimum position. → “Swing” operates at 0%.
2. Change MODULE CONTROL to A. → “Swing” operates at 0%.
3. Move slider 1 to the maximum position. → “Swing” operates at 100%.

The internal settings are automatically controlled so that the phrase being generated does not change abruptly. In the above example when you use MASTER to set “Swing” to 0% and then switch to module A, the displayed indication is 50–100% but the parameter is actually operating at a value of 0%. In this way, you need to be aware that the displayed indication may not match the actual result.

## Perf RTP (Perf Real-Time Parameters)

In the same way as for a program, KARMA parameters other than GE realtime parameters (e.g., KARMA module parameters) can also be assigned to controllers.

These settings are valid when MODULE CONTROL is set to MASTER.

1. Go to the Combination P7: KARMA– Perf Real-Time Parameters page.

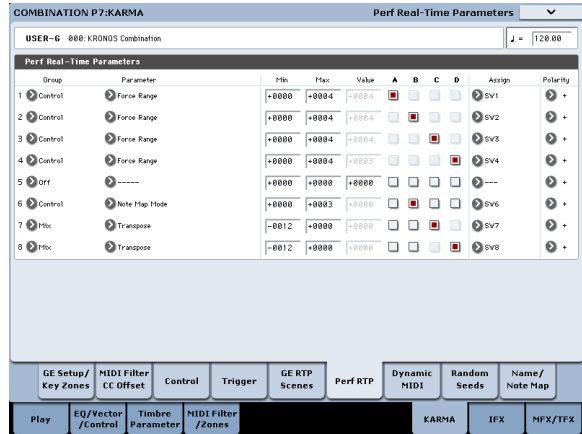

In the same way as for a program, set “Group,” “Parameter,” “Min,” “Max,” “Value,” “Assign,” and “Polarity.” In a combination, you can use the four KARMA modules A, B, C, and D.

Turn on (check) the “A,” “B,” “C,” and/or “D” boxes to select the module(s) you want to control.

In the above example, KARMA REALTIME CONTROLS switches 1, 2, 3, and 4 are controlling the Run/Mute setting of modules A, B, C, and D respectively.

## Dynamic MIDI settings

You can make these settings in the same way as for a program. For more information, see “Dynamic MIDI Sources & Destinations” on page 1114 of the Parameter Guide.

## Naming the KARMA RTC sliders 1–8 and switches 1–8 for MASTER and module A–D

In the same way as for a program, you can select names for the KARMA CONTROLS sliders and KARMA SWITCHES. These settings are saved as part of the combination.

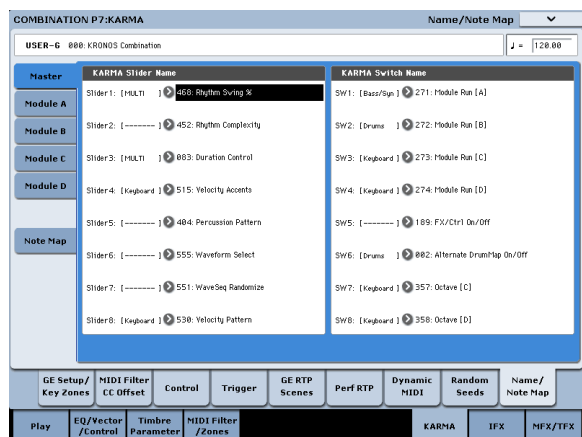

In a combination, the area in square brackets [ ] automatically shows a portion of the category name of the program selected for each timbre controlled by the KARMA CONTROLS sliders and KARMA SWITCHES. This lets you know the timbre whose phrase is being controlled by each KARMA CONTROLS slider and KARMA SWITCH.

If more than one timbre is being controlled, the area in square brackets will indicate “MLTI.”

Auto Assign KARMA RTC Name (See “Auto Assign KARMA RTC Name” on page 149 of the Parameter Guide)

## Specifying the random seeds

For each GE realtime parameter group, you can specify whether the random seed (used to generate random values) will be shared between the four KARMA modules.

### 1. Go to the Combination P7: KARMA– Random Seeds page.

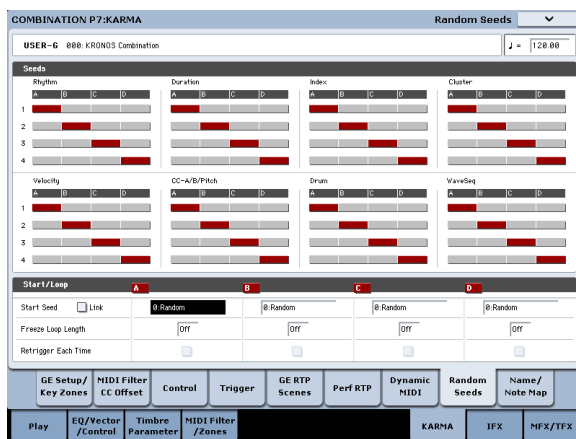

Normally, you will set the four modules to use separate random seeds as shown above; “A”: 1, “B”: 2, “C”: 3, and “D”: 4. If you have selected the same GE for two or more KARMA modules and want them to play in unison using the identical random values, you must select the same random seed for each of these modules. For more information, see “7–8: Random Seeds” on page 487 of the Parameter Guide.

## Linking KARMA settings to Combi changes

KARMA settings can be saved individually for each Combination. Normally, when you select a new Combination, its KARMA settings will be loaded as well. In some cases, however, you may wish to try out different Combinations while keeping the KARMA settings the same.

The Global Basic page **Load KARMA Settings when changing** parameters let you select between these two behaviors. There are separate settings for Programs, Combi, and Songs. To set this up:

1. Go to the Global Basic page.
2. Under “Load KARMA setting when changing”, set the “Combinations” check-box as desired.

Check the box to load the individual Combinations’ KARMA settings.

Un-check the box to keep KARMA settings the same, even when changing Combinations.

For more information, see “Load KARMA settings when changing” on page 755 of the Parameter Guide.



## Using KARMA in Sequencer mode

In Sequencer mode you can use four KARMA modules (modules A, B, C, and D). As in a combination, you can use the KARMA modules to generate independent phrases or patterns that play (for example) drum, bass, guitar, and strings programs, or you can combine the four KARMA modules and the sixteen track programs in a wide variety of ways.

The structure of the KARMA-related parameters is the same as in Combination mode. (See “Editing KARMA in Combination mode” on page 239)

In Sequencer mode, you can use KARMA while realtime-recording song tracks or patterns.

The note-on/off data and MIDI control data generated by a KARMA module can be recorded as events in a track or pattern. At this time, you can use the KARMA CONTROLS sliders and KARMA SWITCHES to control the phrase in realtime while you record it.

You can also copy the settings from a combination, and use multi-track recording to realtime-record your keyboard performance.

 Data from the internal sequencer is not input to the KARMA module. Also, you cannot use note data from the internal sequencer to trigger a KARMA module so that it generates phrases etc.

Here we’ll explain how to use the Auto Song Setup function to get started with realtime recording. We will also describe the procedure for realtime recording (single-track recording) using KARMA, and for realtime recording (multi-track recording) by copying the settings from a combination.

## Auto Song Setup

The Auto Song Setup function automatically copies the settings of a program or combination into a song, and then puts the KRONOS in record-ready mode. You can then begin recording immediately just by pressing the SEQUENCER START/STOP switch. This lets you seamlessly move from playing a program or combination into producing a song, so that phrases or ideas for a song that occur to you while using KARMA can be immediately turned into a song.

Procedure (using the example of Combination mode)

1. **Enter Combination mode.**
2. **In the Combination P0: Play– Prog Select/Mixer page, select a combination and edit the KARMA RTC parameters etc. as desired.**

**Note:** If you want to keep the edited state of your combination, execute “Update Combination” or “Write Combination.”

3. **Hold down the ENTER switch and press the REC/WRITE switch.**

The “Setup to Record” dialog box will appear.

4. **To execute the Auto Song Setup function, press the OK button. If you decide to cancel, press the Cancel button.**

You will automatically move to Sequencer mode, and the settings of the combination will be copied to a song.

The copy-destination song will be the first unused song.

### Content copied from a Combination:

The same content will be copied as when you execute the **Copy From Combi** page menu command with **IFX-All**, **MTFXs**, and **TFXs** checked, and **Multi REC Standby** checked. For more information, see “Copy from Combi” on page 629 of the Parameter Guide.

### Content that is copied from a Program:

The same content will be copied as when you execute the “Copy From Program” page menu command with **IFX-All**, **MTFXs**, and **TFXs** checked, **To:** set to MIDI Track01, **with KARMA** checked and **To:** set to KARMA Module: A, and **with Drum Track** checked and **To:** to set to MIDI Track10.

5. **The KRONOS will automatically enter record-ready mode, and the metronome will begin sounding according to the Metronome setting (Sequencer 0–5c).**
6. **Press the START/STOP switch to begin realtime recording. When you’ve finished recording, press the START/STOP switch once again. (See “Recording MIDI in real-time” on page 84.)**

## Recording using KARMA (single-track recording)

In the following example, we'll use KARMA to record a drum pattern on track 1.

1. Select the desired drum program for track 1 as described in the procedure for realtime-recording a track and for preparing to record (see p.84).

Also make any other necessary settings for recording, such as setting "Track Select" to T01.

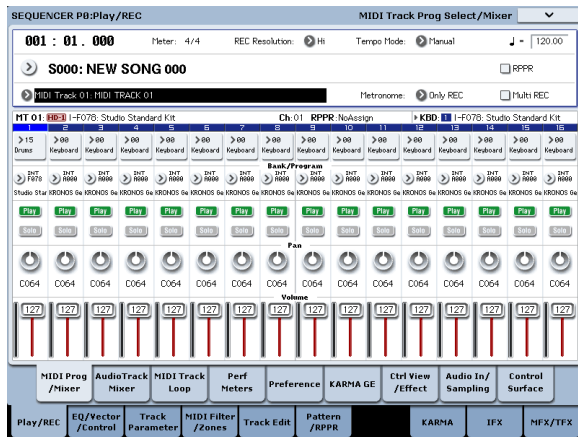

2. Go to the Sequencer P7: KARMA– GE Setup/Key Zones page.

Make MIDI I/O settings for the KARMA modules so that KARMA module A will play track 1 (See "Editing KARMA in Combination mode" on page 239).

For KARMA module A, set the "Input Channel" and "Output Channel" to 01 and 01 respectively. Setting them to Tch and Tch will have the same result. For more information, see "7-1c: MIDI I/O" on page 475 of the Parameter Guide.

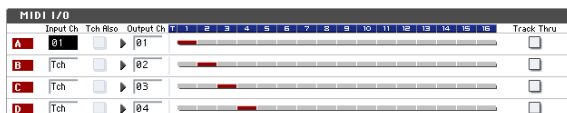

As specified by the MIDI track's MIDI Channel setting and the KARMA module's Out Channel setting, the MIDI track played by the KARMA module is displayed in red.

3. Select a GE for KARMA module A, and set its parameters.

You are free to select a GE and make settings as desired, but in this example we'll use the "Copy KARMA Module" page menu command to copy all of the program's KARMA settings. This is an easy way to set up and record the phrase or pattern that the program's KARMA is generating.

1. Use the page menu button located in the top left of the screen to display the page menu, and choose "Copy KARMA Module."

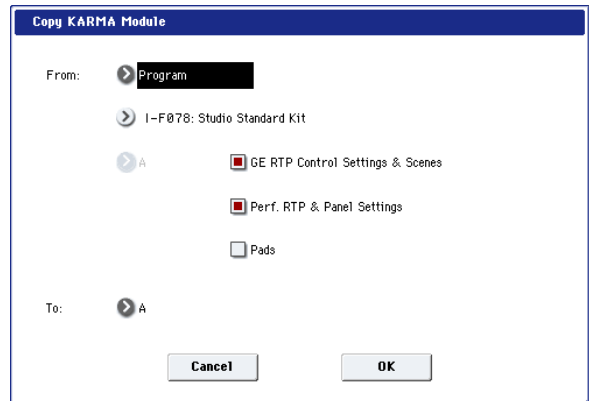

Specify the copy-source program. Turn on (check) "GE RTP Control Settings & Scenes" and "Perf. RTP & Panel Settings." Press OK to execute the copy.

The settings of the KARMA REALTIME CONTROLS sliders, switches, and scenes will be copied to Module Control A.

2. Press the KARMA ON/OFF switch to turn on KARMA.

When you play the keyboard, KARMA will generate a drum pattern just as it did for the program.

3. Use the SEQUENCER REC/WRITE switch and the START/STOP switch to realtime-record on track 1. (See "Recording MIDI in real-time" on page 84)

You can operate the KARMA REALTIME CONTROLS sliders/switches and the SCENE switches while recording, and the changes in the pattern or sound that occur will be recorded just as they occur.

⚠ The song tempo and KARMA tempo cannot be set independently.

4. If you want the KARMA module to be in synchronization with the sequencer during recording, check the "Quantize Trig" option.

Go to the Sequencer P7: KARMA– Module Parameters-Trigger page.

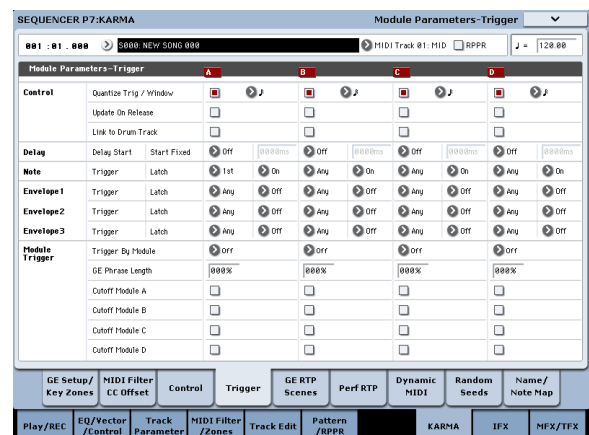

The trigger timing will be synchronized to sixteenth-note intervals of the sequencer beat. (See "Synchronizing KARMA" on page 247)

5. You can synchronize the KARMA module to the start timing of the sequencer.

- While KARMA is running, press the START/STOP switch; KARMA will synchronize to the synthesizer timing.
- If you again press the START/STOP switch, the sequencer and KARMA will both stop. If you want to stop only KARMA, press the (KARMA) ON/OFF switch to turn it off.
- If you want KARMA to start at the moment recording begins, press the (KARMA) ON/OFF switch to turn it on, and then play the keyboard during the pre-count before recording. The KARMA module will not be triggered immediately, but will be triggered in synchronization with the sequencer when recording begins. (See “Synchronizing KARMA” on page 247)

## Multi-track recording using settings copied from a Combination

The pre-loaded combinations include a diverse array of combinations that take full advantage of KARMA. You can play these combinations to stimulate ideas for songs, and record your playing to create basic tracks. Many of these combinations consist of timbres and KARMA modules with differing MIDI channel settings.

In the example below, we’ll show how you can use multi-track recording to record a performance consisting of multiple MIDI channels.

1. We’ll start by copying the settings of a combination into a song. Go to the Sequencer P0: Play/REC– MIDI Track Prog Select/Mixer page.
2. In the upper left of the screen, press the page menu button to open the page menu, and choose “Copy From Combination.”

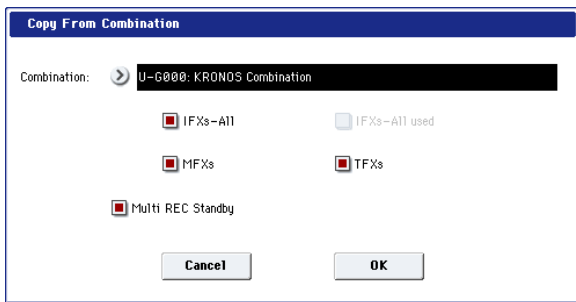

Select the copy-source combination. Turn **IFX-All**, **MFXs**, **TFXs**, and **Multi REC Standby** on (checked). Press OK to execute the copy.

3. The settings of the combination’s timbres 1–16 will be copied to MIDI tracks 1–16. Effect settings, KARMA settings, and all other common parameters will be copied to the tracks of the song.
4. Choose “Track Select.” Select a track whose MIDI channel matches the global MIDI channel.

Press the ON/OFF switch to turn KARMA on, and play the keyboard and/or pads to make KARMA begin playing in the same way as it did in the copy-source combination. (Depending on the track you selected in “Track Source,” the performance may not be the same as when you were playing the combination. Be sure to select the track whose MIDI channel is the same as the global MIDI channel.)

5. Perform multi-track recording. Make preparations for recording as described in “Multi (multitrack recording)” on page 86. Turn “Multi REC” on (checked).

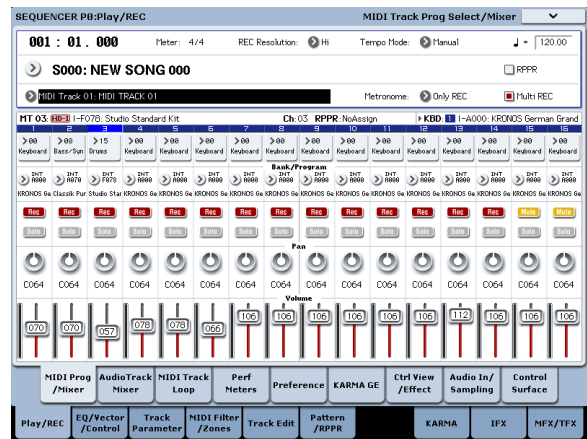

Set the tracks you’re not recording to either Play or Mute. However if you’re recording the performance of a combination, and none of the tracks have already been recorded, it’s OK to leave all tracks set to REC.

6. Press the REC/WRITE switch and then the START/STOP switch to begin realtime recording. (See “Recording MIDI in real-time” on page 84)

While you record, you can operate the KARMA REALTIME CONTROLS sliders, KARMA SWITCHES, and SCENE switches to vary the pattern or sound. The changes you create will be recorded just as you make them.

⚠ The song tempo and KARMA tempo cannot be set independently.

# Synchronizing KARMA

## Synchronization basics

### Synchronization with Wave Sequences

If you want a KARMA module to synchronize with currently-playing Wave Sequences (“Mode”= Tempo), turn “Quantize Trig” on (checked) so that it will synchronize to the selected note interval.

### Synchronization with the Drum Track

For information on synchronizing KARMA with the Drum Track, see “Using KARMA and the Drum Track together” on page 255.

### Synchronization with song start/stop

- While KARMA is running, pressing the START/STOP switch will synchronize KARMA with the sequencer.

KARMA will be reset, and the phrases or patterns it generates will start from the beginning.

- While the sequencer is playing and KARMA is stopped, and you change the location by pressing the LOCATE switch etc., KARMA will be reset, and the phrases or patterns it generates will start from the beginning.
- If you then press the START/STOP switch, the sequencer and KARMA will both stop. If you want to stop only KARMA, press the (KARMA) ON/OFF switch.
- If you want KARMA to start the moment recording begins, press the (KARMA) ON/OFF switch, and then play the keyboard during the pre-count before recording. The KARMA modules will not be triggered immediately, but will be triggered in synchronization with the sequencer the moment recording starts.

## The “Quantize Trigger” parameter

The trigger timing of a KARMA module will depend on the setting of its “Quantize Trig” (short for “Trigger”) parameter.

**On (checked):** The trigger timing of a KARMA module will be quantized to the selected note interval.

**Off (unchecked):** The KARMA module will be triggered at the timing at which you play the keyboard.

For more information, see “Quantize Trigger” on page 116 of the Parameter Guide.

**Note:** If you want a wave sequence to synchronize to the currently-playing KARMA, go to the P2: Track Parameters Wave Sequence/KARMA page and turn “Wave Sequence Quantize Trigger” on.

### Synchronization between KARMA modules A, B, C, and D

In Combination and Sequencer modes, four KARMA modules can be running. Each module has a “Quantize Trig” setting that determines how that module will synchronize with the other modules.

**“Quantize Trig” Off:** The KARMA module will be triggered at the timing at which you play the keyboard. There will be no synchronization between KARMA modules; each will be triggered at their own timing.

**“Quantize Trig” On:** The KARMA module will synchronize to the selected note interval of the timing the first-triggered KARMA module that is currently running.

If you want to simultaneously trigger multiple KARMA modules from the keyboard or pads, turn “Quantize Trig” on for each of these KARMA modules.

### Synchronization with songs, patterns, and RPPR performance in Sequencer mode

If you want a KARMA module to play (or be recorded) in synchronization with the currently-playing song, pattern, or RPPR, turn “Quantize Trig” on.

**“Quantize Trig” Off:** The KARMA module will be triggered at the timing at which you play the keyboard. It will not synchronize to the currently-playing song, pattern, or RPPR.

**“Quantize Trig” On:** The trigger timing of the KARMA module will be quantized to the selected note interval of the currently-playing song, pattern, or RPPR.

**Note:** If you want patterns played by RPPR to synchronize to the currently-operating KARMA, set “Sync” (Sequencer P5: Pattern/RPPR– RPPR Setup page) to SEQ.

**Note:** If you want a wave sequence to synchronize to the currently-playing song, pattern, RPPR, or the currently-running KARMA, go to the P2: Track Parameters Wave Sequence/KARMA page and turn on “Wave Sequence Quantize Trigger” as well. For more information, see “Wave Sequence Quantize Trigger” on page 464 of the Parameter Guide.

---

## Slave operation

Connect the MIDI OUT of your external MIDI device to the KRONOS' MIDI IN.

Set **MIDI Clock** (Global 1–1a: MIDI Setup) to External MIDI. The KRONOS will synchronize to MIDI realtime clock and realtime command messages it receives from the connected MIDI device.

**Note:** If the KRONOS is set to MIDI Clock= Auto, it will also synchronize to the external MIDI device in the same way if MIDI realtime clock messages are being received from the external device.

---

### Synchronization to MIDI clock

KARMA will synchronize to a tempo based on the external MIDI clock timing.

---

### Synchronization with MIDI realtime commands

In Sequence mode, Song Start, Continue, and Stop messages that the KRONOS receives will control song playback and recording just as when you operate the front panel

START/STOP switch. KARMA also will be controlled in the same way as when you operate the front panel START/STOP switch. (See “Synchronization with song start/stop”)

When the KRONOS receives a Song Position Pointer message, it will change the location of the song just as when you change the song location by operating the KRONOS, and KARMA will be controlled in the same way as when you change the location on the KRONOS.

In Program and Combination modes, Song Start, Continue, and Stop messages that the KRONOS receives will control KARMA.

- While KARMA is running, Song Start, Continue, and Song Position Pointer messages received by the KRONOS will reset KARMA, causing the generated phrases or patterns to start from the beginning.
- If a Song Stop message is received, KARMA will stop.

---

## Master operation

Connect the KRONOS' MIDI OUT to the MIDI IN of your external MIDI device.

Set **MIDI Clock** (Global 1–1a) to Internal. The connected external MIDI device will synchronize to the MIDI realtime clock and realtime commands it receives.

**Note:** The same applies if MIDI Clock=Auto and MIDI realtime clock messages are being transmitted. For more information, see “MIDI Clock (MIDI Clock Source)” on page 773 of the Parameter Guide.

---

### Synchronization via MIDI clock

The connected external MIDI device will synchronize to the MIDI clock of the KRONOS.

---

### Synchronization via MIDI realtime commands

#### Enable Start/Stop Out in Prog/Combi

You can set up KRONOS so that starting and stopping KARMA in Program and Combi modes will also control start and stop on external MIDI devices, such as sequencers and drum/groove machines (such as the Korg Electribe series).

To do so:

1. Go to the **Global MIDI** page.
  2. Under **MIDI Routing Setup**, turn on “**Enable Start/Stop Out in Prog/Combi.**”
- In Program and Combination modes, playing a note-on from the keyboard or pads to trigger the GE selected for a KARMA module will also cause the MIDI system realtime message “Start” to be sent at the trigger timing.

- After the Start message has been sent, turning off KARMA ON/OFF will send the MIDI system realtime “Stop” command.

# Using the Drum Track

## Overview

---

### What is the Drum Track?

The Drum Track is a built-in drum machine, fueled by the KRONOS's high-quality drum sounds.

It gives you a beat to play along with as you experiment with Programs and Combinations, or as you work out the outline of a song. If you're playing with the Drum Track and want to capture your inspiration quickly, you can use Auto Song Setup to immediately start recording in Sequencer mode.

There are hundreds of preset Drum Track patterns covering a wide range of musical styles, and you can also create your own (as we'll explore later in this chapter).

#### *Drum Track Pattern contents*

<b>Bank</b>	<b>Contents</b>
Preset P000...718	Factory Drum Track patterns
User U000...999	User Drum Track patterns

There are options to control how the Drum Track pattern starts, such as starting immediately when you press the DRUM TRACK button, or waiting until you start to play the keyboard. If you're starting the pattern by playing the keyboard, you have the option of starting it by using a specific range of notes or velocities.

You can also link the Drum Track with KARMA, so that they play in sync and start and stop together.

In Program mode, the Drum Track has its own mixer channel (including EQ) and separate effects routing, for independent control of the sound. In Combinations and Songs, the Drum Track plays normal Timbres and Tracks, with all the normal controls over Program selection, EQ, effects routing, and so on.

## Performing with the Drum Track

### Using the Drum Track in Program mode

In Program mode, the Drum Track lives alongside the main Program, similar to a second MIDI Track in Sequencer mode.

Here we'll explain how to make the most important settings. For more details, please see "1-3: Drum Track" on page 42 of the Parameter Guide.

#### Turning the Drum Track on and off

##### 1. Press the DRUM TRACK switch.

The switch's LED will either light solidly or blink on and off, depending on the Program's **Trigger Mode** setting.

If the LED is solidly lit: this means that the **Trigger Mode** is set to **Start Immediately**. The Drum Track pattern will start according to the **Sync** setting (for more information, see "Controlling how the Drum Track starts and stops" on page 253). When you turn it off, the pattern will stop.

If the LED is blinking: this means that the **Trigger Mode** is set to **Wait KBD Trig**. The Drum Track pattern will start when you play the keyboard or when a MIDI note-on is received. If the front panel LINKED LED and KARMA ON/OFF switches are lit, the KARMA performance will start and stop together with the Drum Track.

*Note:* If the selected pattern is either P000:Off or is empty (which can happen with User patterns), the DRUM TRACK switch won't turn on.

#### Setting the tempo

##### 1. Use the TEMPO knob or the TAP TEMPO button to set the tempo.

This sets the system tempo, as shown in the "♩=" value located in the upper right of the display. The TAP TEMPO button's LED also shows the tempo, blinking at intervals of a quarter note (♩).

You can also edit the tempo directly from the display using the standard data entry controls, including the numeric keypad. Simply select the "♩=" in the display, and then enter a value.

The tempo is variable between 40.00–300.00 bpm, and is saved when you write the Program.

##### External clock

If the **MIDI Clock** parameter (on the Global MIDI Basic page) is set to External MIDI or External USB, or to Auto MIDI or Auto USB if MIDI Clock messages are being received, the tempo value will display as "♩=" EXT, and the KRONOS will sync to the incoming clocks. When syncing to external clock, the TEMPO knob and TAP TEMPO button have no effect.

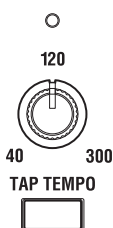

#### Selecting the Drum Track pattern & sound

##### 1. Press the Basic/Vector tab, and then press the Drum Track tab.

The Drum Track page will appear.

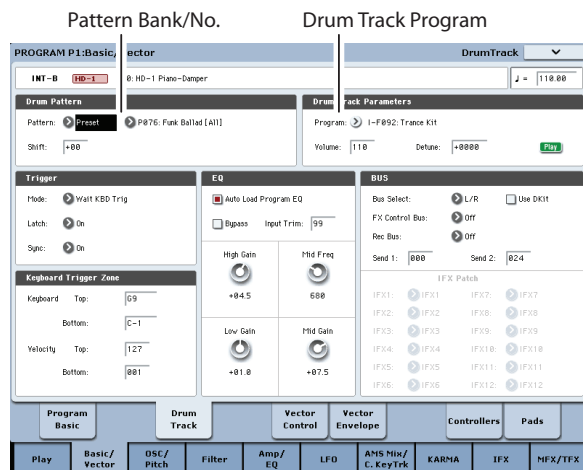

##### 2. Note the Drum Pattern section, in the upper left of the display.

The Pattern parameter has two popup menus. The one on the left selects between the Preset and User banks; the one on the right selects the pattern within the bank.

##### 3. In the popup menu on the left, select the Preset bank.

##### 4. In the popup menu on the right, select pattern P001: Pop & Ballad [All].

Next, note the Drum Program section of the page (to the right of the Drum Pattern section). This area contains a few parameters for adjusting the basic sound of the Drum Track.

##### 5. Press the Program popup menu.

The Category/Program Select dialog appears. By default, the Drum category will already be selected.

##### 6. Select a drum Program for the Drum Track to play.

You can actually select any sound, even outside of the Drum category—but in general, the patterns will only make sense when playing a drum Program.

##### 7. Use Volume to adjust the volume of the Drum Track Program.

##### 8. Use Detune to adjust the overall pitch of the Drum Program in one-cent increments.

One cent is 1/100th of a semitone.

You can adjust the pitch of individual Drumsamples by editing Drum Kits in Global mode.

#### Shift

**Shift** lets you transpose the Drum Track pattern in semitone steps, causing different instruments of the drum kit to play. This will generally cause unexpected results, which may often be interesting—experiment and see!



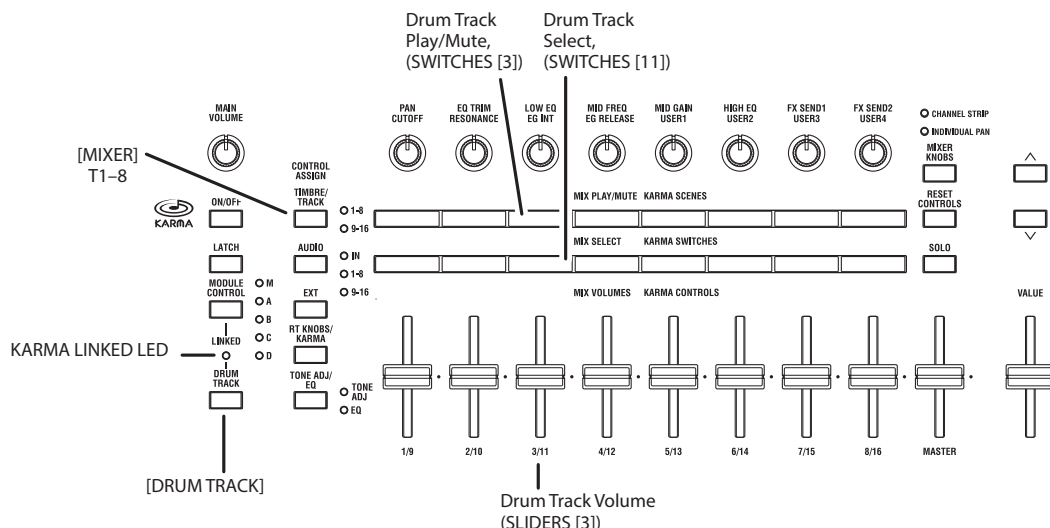

### Linking with KARMA

You can link KARMA and the Drum Track so that they start and stop together.

1. Go to the KARMA Trigger page.
2. In the Module Parameters - Trigger section, in the Control Group, note the Link to Drum Track checkbox.
3. Turn on Link to Drum Track.

The front panel LINKED LED will light.

If Link to Drum Track is on, KARMA will be linked with the Drum Track start/stop.

4. Turn the KARMA ON/OFF switch on.

When linked, KARMA will always wait for the Drum Track. So, unless the DRUM TRACK switch is on, KARMA won't start yet.

5. Turn the DRUM TRACK switch on.

KARMA will start to play along with the Drum Track, according to the Drum Track's Trigger Mode. See "Turning the Drum Track on and off," above, for more information.

If you turn off the DRUM TRACK switch while KARMA is operating, KARMA will also stop.

For more details, please see "Using KARMA and the Drum Track together," on page 255.

### Drum Track and the Control Surface

You can use the control surface to control the Drum Track's mix parameters, including volume, play/mute, solo on/off, EQ, and effects sends.

1. Play a Drum Track pattern.  
See "Turning the Drum Track on and off" on page 250.
2. Press the CONTROL ASSIGN TIMBRE/TRACK switch.
3. On the display, press the Play tab, and then press the Control Surface tab.

The Control Surface page will appear.

This page displays and reflects the control surface settings. It's convenient to watch this page while using the control surface, since it shows the parameter names and precise values.

*Note:* You can use the control surface regardless of the page that's currently shown in the display.

4. Use slider 3 to adjust the Drum Track volume.
5. Use Play/Mute switch 3 to toggle the Drum Track's sound on and off.

Note that this controls only the sound of the Drum Track Program, and is independent of whether or not the Drum Track pattern is playing.

6. Press the MIXER KNOBS button until the CHANNEL STRIP LED lights up.

This makes the knobs control a virtual channel strip, including pan, EQ, and effects sends.



7. Press the MIX SELECT 3 button to select the Drum Track on the Control Surface.
8. Use knobs 2-6 to adjust the Drum Track's EQ.

---

## Using the Drum Track in Combination mode

---

### Turning the Drum Track on and off

You can turn the Drum Track on and off, and control the tempo, just as in Program mode. For more information, see “Turning the Drum Track on and off” on page 250, and “Setting the tempo” on page 250.

---

### Selecting a Drum Track pattern and sound

In Program mode, the Drum Track has a special reserved mixer slot, a dedicated Program select parameter, and so on—and the Drum Track pattern always plays that dedicated Program. In Combinations (and Songs), the Drum Track simply sends MIDI to play one or more of the 16 Timbres/Tracks.

To set up the Drum Track in Combination mode:

1. **Go to the Combination Play page.**
2. **Choose a Timbre to use as the Drum Track Program.**

You can use two or more Timbres at once, if you want to get really fancy—but in general, all you’ll need is one. In this case, let’s use Timbre 10.

3. **Open the Timbre’s Category popup, and select a drum Program.**

I-F078 Standard Kit is a good first choice.

4. **Go to the Timbre Parameters MIDI page.**
5. **Set Timbre 10 (the drum Program) to MIDI channel 10.**

*Note:* if another timbre uses the same MIDI channel, the drum pattern will play that timbre as well.

You can use any MIDI channel, but it’s best to use something other than the Global MIDI channel. Otherwise, the Drum Track pattern will play all of the sounds assigned to the keyboard, with unpredictable results.

6. **Go to the EQ/Vector/Control page, and select the Drum Track tab.**

In the MIDI Channel section, set the **Output to 10** (to match the Timbre’s channel, as set in step 5).

7. **In the upper left of the page, select a Drum Pattern.**

For more details, see “Selecting a Drum Track pattern and sound” on page 252.

*Note:* If you select an empty pattern, you won’t be able to turn the DRUM TRACK switch on.

8. **Press the DRUM TRACK switch to verify that the pattern sounds correctly.**

The method of triggering will depend on the Trigger settings. If **Trigger Mode** is Start Immediately, the Drum Track pattern will start when you press the ON/OFF switch. For more information, please see “Synchronizing the Drum Track” on page 256.

## Drum Track settings

### Drum Track settings in Program mode

#### Controlling how the Drum Track starts and stops

You have several options to control how and when the Drum Track starts and stops.

1. Go to the **Basic/Vector** page, and select the **Drum Track** tab.
2. In the **Trigger** section, set the **Mode** to control how the pattern will start and stop.

**Start Immediately:** When you turn on the Drum Track by pressing the DRUM TRACK switch, the LED will light and the Drum Track pattern will start according to the **Sync** setting. It will stop when you turn off the switch.

**Wait KBD Trig:** When you press the DRUM TRACK switch to turn it on, the LED will blink and the Drum Track pattern will wait to start. When you play the keyboard or receive a MIDI note-on, the Drum Track pattern will start according to the **Sync** setting.

3. Specify the **Sync** setting.

**Off:** The Drum Track pattern will not synchronize to the currently-running KARMA, but will start immediately.

**On:** The Drum Track pattern will synchronize to the currently-running KARMA.

For more information, see “The Trigger “Sync” parameter” on page 256.

4. If **Trigger Mode** is set to **Wait KBD Trig**, specify the **Latch** setting.

**Latch** controls whether the Drum Track pattern will continue playing even after you take your hands off of the keyboard.

**Off:** If the DRUM TRACK switch is on, the LED will blink, and the pattern will start when you play the keyboard. When you stop playing, the Drum Track will stop as well.

**On:** If the DRUM TRACK switch is on (the LED will blink), the pattern will start when you play the keyboard (note-on). The pattern will continue when you release the keyboard (note-off). The pattern will stop when you turn the DRUM TRACK switch off (the LED will go dark).

**Use KARMA Latch Switch:** The on/off status of the KARMA LATCH switch will correspond to the above Off and On modes of operation. You will probably want to use this in conjunction with KARMA’s Latch operation.

5. If **Trigger Mode** is set to **Wait KBD Trig**, specify the **Keyboard Zone** and **Velocity Zone**.

These settings specify the range of keys and velocities that will trigger the Drum Track pattern when you play the keyboard (or receive a note-on).

#### Storing the on/off setting

If the **Trigger Mode** is set to **Wait KBD Trig**, the on/off status of the DRUM TRACK switch is also saved when you save the Program.

If the **Trigger Mode** is set to **Start Immediately**, the switch status is always saved as **Off**, regardless of whether the switch is on or off when you **Write**.

#### EQ adjustments for the Drum Track Program

The Drum Track Program has its own three-band EQ, just like the Program’s oscillators. You can control this on the Drum Track page, or directly from the Control Surface as with the oscillator EQs.

If you enable **Auto Load Program EQ**, the EQ settings stored in the Drum Program will be automatically loaded when you switch Drum Track Programs. Normally, you should leave this enabled.

Even if **Auto Load Program EQ** is enabled, you can still adjust the EQ manually.

#### MIDI in and out

The Drum Track can interact with MIDI in several different ways. You can:

- Trigger the Drum Track pattern via MIDI in
- Play the Drum Track Program via MIDI in
- Transmit the Drum Track pattern via MIDI out

#### Triggering the Drum Track pattern via MIDI

If you’re triggering the Drum Track pattern by playing the keyboard, input on the Global MIDI Channel will trigger the Drum Track as well.

#### Playing the Drum Track Program via MIDI

You can play the Drum Track Program via MIDI, separately from the main Program sound. In Program mode, the Drum Track’s MIDI channel is set by the Global MIDI page’s **Prog MIDI Ch** parameter. The default is channel 10.

(In Combination and Sequencer modes, this works a little differently; see “Drum Track settings in Combination mode,” below.)

Note that the Drum Track Program does not transmit or receive Program changes.

#### Transmitting the Drum Track pattern via MIDI

With the factory settings, the Drum Track pattern will not be sent via MIDI out. If you like, however, you can do so—for instance, you could use it to play an external MIDI device, or record it into an external sequencer. To do so:

1. Go to the **Global MIDI** page.
2. Under **Drum Track MIDI Setup**, enable **Prog MIDI Out**.
3. Set the **Prog MIDI Ch.** as desired.

The Drum Track pattern will then transmit MIDI on the selected channel.

## Drum Track settings in Combination mode

Unlike Program mode, Combination mode does not have a dedicated track for the Drum Track. Instead, you can assign any of the 16 Timbres to the Drum Track.

To do so, select a drum Program for the desired Timbre. Then, set the Drum Track's **Output** MIDI channel to match the timbre's MIDI channel.

### MIDI in and out

In Combination mode, MIDI interacts with the Drum Track differently than in Program mode. You can still:

- Trigger the Drum Track pattern via MIDI in
- Play the Drum Track Program via MIDI in
- Transmit the Drum Track pattern via MIDI out

### Triggering the Drum Track pattern via MIDI

If you're triggering the Drum Track pattern by playing the keyboard, input on the Global MIDI Channel will trigger the Drum Track as well.

### Playing the Drum Track Program via MIDI

Since the Drum Program(s) use standard Combination Timbres, you can play the Drum Program just as you would any other Timbre.

### Transmitting the Drum Track pattern via MIDI

The Drum Track will transmit on the MIDI channel specified by the Drum Pattern **Output** setting of each Combination.

Set this to match the MIDI channel of the timbre you've specified for the drum Program.

If the timbre's **Status** is EXT or EX2, the Drum Track pattern will be transmitted via MIDI out

## Drum Track settings in Sequencer mode

The Drum Track works much the same in Sequencer mode as it does in Combination mode.

However, while Combinations trigger the Drum Track pattern via the global MIDI channel, Songs trigger the Drum Track pattern on the MIDI channel specified by Drum Pattern **Input**. Normally you'll set this to Tch. With the Tch setting, the MIDI channel of the track selected by **Track Select** will automatically be used as the trigger channel.

For details, please see "Selecting the Drum Track pattern & sound" on page 250.

### Drum Track MIDI in and out

In Sequencer mode, the Drum Track transmits and receives on the following MIDI channels.

**Receive:** The Drum Track will receive on the MIDI channel specified by the Drum Pattern **Input** setting of each song. Normally you'll set this to Tch and use the KRONOS's keyboard to control the triggering.

**Transmit:** The Drum Track will transmit on the MIDI channel specified by the Drum Pattern **Output** setting of each song. Set this to match the MIDI channel of the MIDI track for which you've assigned the drum Program.

If the track's **Status** is BTH, EXT, or EX2, note data etc. of the Drum Track pattern will be transmitted.

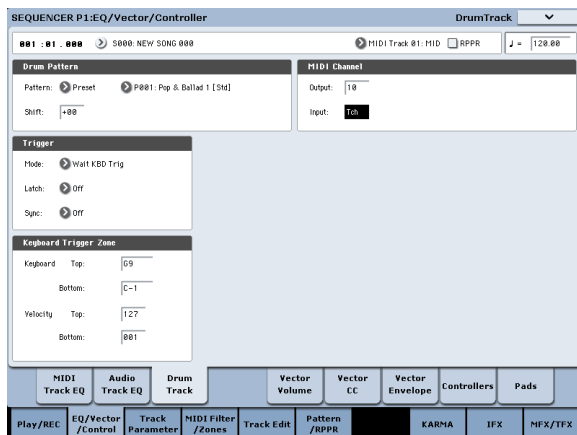

In Sequencer mode you can use the Drum Track while real-time-recording a song track or pattern.

The note-on/off data transmitted by the Drum Track pattern can be recorded as events in a track or pattern.

 You can't use note data from the internal sequencer as a trigger to start Drum Track patterns.

If you're playing a Program or Combination along with the Drum Track and come up with an idea for a song, you can use Auto Song Setup to immediately start recording. For more information, see "Auto Song Setup" on page 88.

## Using KARMA and the Drum Track together

If you're using the Drum Track and KARMA together, you can link the start/stop operation of both, and specify whether or not the Drum Track pattern will play for each KARMA scene.

### Settings in Program mode

#### Linking KARMA with Drum Track start/stop

Here's how to start and stop the KARMA performance along with the Drum Track pattern:

- 1. Go to the Program P7: KARMA Module Parameters–Trigger page.**

- 2. Turn on Link To Drum Track.**

The front panel LINKED LED will light.

If **Link to Drum Track** is on (selected), KARMA will be linked with the Drum Track start/stop.

- 3. Turn the KARMA ON/OFF switch on.**

Even when you play the keyboard (or receive a note-on), KARMA will not be triggered.

- 4. When you turn the DRUM TRACK switch on, the Drum Track will start at the specified timing.**

If **Trigger Mode** is set to Start Immediately, KARMA will be triggered and begin operating when you turn the DRUM TRACK switch on (if you're playing the keyboard, or if the KARMA LATCH switch is on).

If **Trigger Mode** is set to Wait KBD Trig, operation will begin when you play the keyboard (or when a note-on is received).

If you turn the DRUM TRACK switch off while KARMA is operating, KARMA will also stop.

#### Turning Drum Track on and off for each KARMA scene

For each KARMA scene, you can control whether or not the Drum Track will play. To do so:

- 1. Go to the Prog P7: KARMA GE Real-Time Parameters/Scenes page.**

- 2. Select the Scenes tab, on the left-hand side of the page.**

The Scenes page will appear.

- 3. In Drum Track Run, clear the check box of each scene for which you don't want the Drum Track to play.**

For example, you might turn this on for scene 1 and off for scene 2.

- 4. Press the KARMA ON/OFF switch to turn it on.**

On the Control Surface, select scene 1.

- 5. Press the DRUM TRACK switch.**

If **Trigger Mode** is set to Wait KBD Trig, play the keyboard (or transmit a note-on via MIDI).

Verify that KARMA and the Drum Track pattern are playing.

- 6. On the Control Surface, select scene 2.**

You'll stop hearing the Drum Track pattern. If you press the SCENE 1 switch, you'll hear the Drum Track pattern again.

### Settings in Combination and Sequencer modes

#### Linking the KARMA performance with the Drum Track pattern start/stop

In Combination mode and Sequencer mode, KARMA can operate up to four KARMA modules simultaneously. Start/stop for each KARMA module can be synchronized with the Drum Track pattern start/stop.

Here we'll explain how to make settings in Combination mode. Settings for Sequencer mode are the same as in Combination mode.

- 1. Go to the Combi P7: KARMA Module Parameters–Trigger page.**

- 2. Under Control, turn on the Link to Drum Track setting for the KARMA module(s) that you want to link with the Drum Track pattern start/stop.**

When you turn on Link for at least one of the four modules, the front panel LINKED LED will light.

- 3. When you turn the KARMA ON/OFF switch on and play the keyboard (or receive a note-on), the KARMA modules whose Link to Drum Track is off will be triggered, and will start. KARMA modules whose Link to Drum Track is on will not be triggered.**

- 4. When you turn the DRUM TRACK switch on, the KARMA modules whose Link to Drum Track is on will start along with the Drum Track.**

If **Trigger Mode** is set to Start Immediately, KARMA will be triggered when you turn the DRUM TRACK switch on, and will begin operating (if KARMA LATCH is on).

If **Trigger Mode** is set to Wait KBD Trig, it will begin operating when you play the keyboard (or receive a note-on).

If you turn the DRUM TRACK switch off while KARMA is operating, KARMA will also stop if KARMA LATCH is off.

- 5. Make settings so that the beat will match (synchronize to) the operating KARMA modules.**

In the Trigger section of the Drum Track page, turn Sync on.

- 6. Make settings so that the KARMA modules will synchronize to the currently-running Drum Track pattern.**

In the P7: KARMA Module Parameters-Trigger page, turn **Quantize Trig** on (selected).

#### Specifying whether the Drum Track will play for each KARMA scene

Just as you can in Program mode, you can specify whether the Drum Track will play for each KARMA scene in Combination mode and Sequencer mode. These settings are made by the respective P7: KARMA GE Real-Time Parameters/Scenes page **Drum Track Run** parameters. For more information, see "Turning Drum Track on and off for each KARMA scene" on page 255.

---

## Synchronizing the Drum Track

---

### The Trigger “Sync” parameter

The trigger timing of a Drum Track will depend on the setting of its Trigger **Sync** parameter.

**On (checked):** The trigger timing will be quantized to the nearest beat relative to the base tempo.

**Off (unchecked):** If **Trigger Mode** is Start Immediately, triggering will occur at the moment you press the DRUM TRACK switch. If this is set to Wait KBD Trig, triggering will occur at the moment you play the keyboard.

### Synchronizing the Drum Track with KARMA, the Sequencer, and RPPR performance

If you want the Drum Track pattern to play in sync with the currently-operating KARMA function, currently-playing song, or RPPR performance, turn Trigger **Sync** on.

**Trigger Sync Off:** If the **Trigger Mode** setting is Start Immediately, the Drum Track pattern will be triggered the moment you press the DRUM TRACK switch. If this is set to Wait KBD Trig, the Drum Track pattern will be triggered the moment you play the keyboard. It will not synchronize to the currently-operating KARMA function or to the currently-playing song, pattern, or RPPR.

**Trigger Sync On:** Triggering will synchronize to the currently-playing song, pattern or RPPR performance in units of a measure. Triggering will synchronize to the currently-operating KARMA function (in Sequencer mode if the song or pattern is stopped) in units of a beat.

*Note:* If you want to synchronize KARMA to the currently-running Drum Track, enable the **Quantize Trig** parameter (Prog P7: KARMA– Trigger, Combi/Seq P7: KARMA Module Parameters-Trigger).

*Note:* If you want to synchronize the RPPR pattern performance to the currently-running Drum Track, set the **Sync** parameter to Beat or Measure.

---

### Synchronization with Songs

- When you press the SEQUENCER START/STOP switch, the Drum Track will stop along with the sequencer.
- If you want the Drum Track to start simultaneously with the beginning of recording, press the DRUM TRACK switch during the pre-count before recording (if **Trigger Mode** is Start Immediately) or play the keyboard (if **Trigger Mode** is Wait KBD Trig). The Drum Tracks will not be triggered immediately, but will be triggered in synchronization with the sequencer the moment recording starts.

---

### Slave operation

Connect the KRONOS’s MIDI IN to your external MIDI device’s MIDI OUT, or connect the KRONOS’s USB B connector to your computer’s USB port. Then, set up the KRONOS as described under “MIDI Clock synchronization” on page 170.

### Synchronization with MIDI real-time commands

In Sequencer mode, Song Start, Continue, and Stop messages that the KRONOS receives will control song playback and recording just as when you operate the front panel START/STOP switch. KARMA also will be controlled in the same way as when you operate the front panel START/STOP switch. (See “Synchronization with Songs,” above.)

---

### Master operation

Connect the KRONOS’s MIDI IN to your external MIDI device’s MIDI OUT, or connect the KRONOS’s USB B connector to your computer’s USB port.

Set the Global **MIDI Clock** to Internal. The connected external MIDI device will synchronize to the MIDI real-time clock and real-time commands it receives.

*Note:* You can also use **MIDI Clock**=Auto MIDI or Auto USB, as long as clock messages are not being received. For details, please see “MIDI Clock synchronization” on page 170.

### Synchronization via MIDI clock

The connected external MIDI device will synchronize to the MIDI clock of the KRONOS.

## Creating Drum Track patterns

To create a Drum Track pattern, you'll use the Sequencer mode P10: Pattern/RPPR– Pattern Edit page to convert a user pattern into a user Drum Track pattern. Once you've converted the pattern in this way, you'll be able to use it with

the Drum Track in each mode. These converted Drum Track patterns are held in internal memory even after you turn off the power. This means you can manage them together with the Programs and Combinations.

## Preparing a user pattern

You'll first need to prepare the user pattern that you want to convert to a Drum Track pattern.

To create a user pattern, you can record the pattern in real-time in the Sequencer Pattern/RPPR– Pattern Edit page, or step-record it.

Alternatively, performance data from a track can be imported into a pattern, meaning that performance data you've created in a track or SMF data you've loaded in Media mode can be used as a user pattern. To do this, execute the **Get From Track** menu command in the Sequencer Pattern/RPPR– Pattern Edit page.

## Converting a Sequencer pattern to a Drum Track pattern

1. Press the front-panel SEQ switch to enter Sequencer mode.
2. Go to the Sequencer Pattern/RPPR– Pattern Edit page.
3. Select the user pattern that you want to convert to a Drum Track pattern.

Set **Pattern** to User, and use **Pattern Select** to select the desired pattern.

4. Choose the menu command **Convert to Drum Trk Pattern** to open the dialog box.

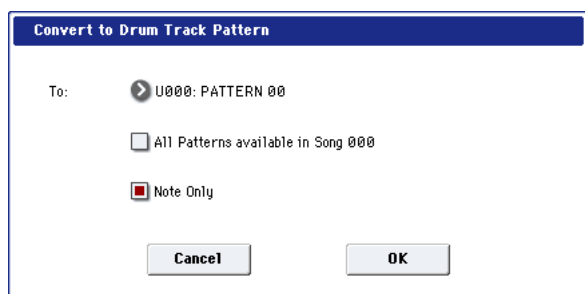

5. Use the To “Drum Track Pattern Select” field to specify the user Drum Track pattern number that will hold the converted data. When you execute the command, the data will be overwritten onto this number.
6. If you select the “All Patterns available in Song \*\*\*” option, all patterns in the song that contain note data will be converted, starting with the number you specified in step 4.
7. If you execute this command with “Note Only” selected, only the note events will be converted.
8. Press the OK button to convert the pattern. Alternatively, press the Cancel button or the EXIT switch to exit without making changes.
9. As described in “Using the Drum Track in Program mode” on page 250, set the Drum Track “Pattern Bank” to User, and set “Pattern No.” to the user Drum Track pattern you converted. Then play the Drum Track pattern.

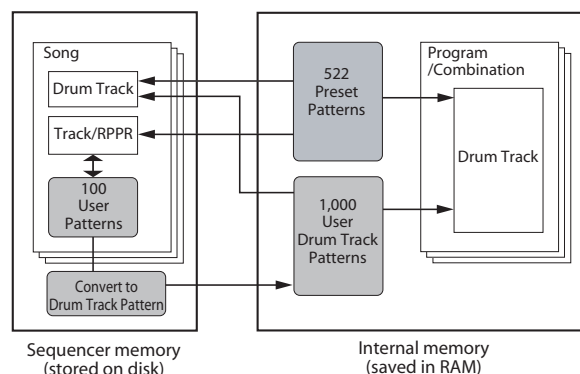





# Appendices

## Troubleshooting

---

### Power supply

---

#### Power does not turn on

Is the power cable connected to an outlet? For more information, see “Connections” on page 21.

Is the POWER switch turned on?

- Turn on the rear panel POWER switch. See “Turning the power on/off” on page 20.

#### Power turns off automatically

Is the Auto power-off function enabled? For more information, see “Auto Power-Off” on page 20.

---

### LCD screen

---

#### Display is blank or incorrect

**The power is turned on, but nothing is shown in the LCD screen. However, the KRONOS functions normally when you play the keyboard or perform other operations.**

Is the LCD screen’s backlight brightness adjusted correctly?

1. Press the GLOBAL button.
2. Check that the GLOBAL button’s LED is lit.

If it is not lit:

- 2a. If the Sequencer START/STOP button’s LED is flashing, press the button so that the LED turns off.
- 2b. Similarly, if the Sampling START/STOP button’s LED is lit, press the button so that the LED turns off.
- 2c. Press the EXIT button several times to cancel any other operations.
- 2d. Finally, press the GLOBAL button again.

Once the GLOBAL buttons’s LED is lit:

3. Press the EXIT switch twice.
4. Hold down the ENTER switch, and press numeric key 6.

The LCD Setup dialog will appear.

5. Use the VALUE slider or VALUE dial to increase the brightness to an appropriate level.

You can also press the RESET CONTROLS button to reset this to the standard value of 63.

6. Press the OK button to confirm the change.

**The power is turned on, but the LCD screen does not display normally, or an error message is displayed. There is no sound when you play the**

If the KRONOS is not cooled adequately, the internal temperature will rise. The power supply may shut down automatically to protect the device from high temperatures.

---

#### Startup does not complete

In some cases, the KRONOS will not start up properly if certain USB storage devices are connected. In this case, disconnect the USB devices from the KRONOS, wait about 10 seconds, and then turn on the power again. You may be able to solve the problem by formatting the USB device on the KRONOS (see “Formatting media” on page 198).

---

#### keyboard, and the KRONOS does not function normally.

It is possible that the system has been damaged. Use the included Accessory Disks to restore the KRONOS to its factory state.

---

#### HD-1 Program P0: Play page display

The HD-1’s Program P0: Play page can display either photos or other images representing the sound, or the Overview/Jump graphics which show the settings of various important parameters (such as EGs, LFOs, and so on).

The choice of which to display is controlled by a combination of the Program P1: Program Basic page’s **Play Page MS/WS/DKit Display** parameters (one for each Oscillator) and the Program P0: Play page’s **Show MS/WS/DKit Graphics** menu command. You can set these as desired.

For more information, see “1–1h: Play Page MS/WS/DKit Display” on page 41 of the Parameter Guide and “Show MS/WS/DKit Graphics,” on page 149 of the Parameter Guide.

---

#### Problems using the touch-screen

##### Can’t operate the LCD screen correctly

On the Basic Setup tab of the Global P0 page, use the **Touch Panel Calibration** page menu command to adjust the touch panel response.

*Note:* If you are unable to select commands from the page menu, do the following:

1. Press the GLOBAL switch.
2. Press the EXIT switch twice.
3. Hold down the ENTER switch and press 3 on the numeric keypad.

The Touch Panel Calibration page will appear. Follow the on-screen instructions to re-calibrate the touch panel.

### Can't switch modes or pages

If the KRONOS is doing any of the following, you may not be able to change modes or switch to a different page:

- Recording or playing back a song or pattern
- Sampling (if the Sampling REC button is lit)
- Playing a CD on a connected USB CD drive
- Playing a WAVE file
- A menu dialog or select dialog is on the LCD display

### In Combination or Sequencer modes, can't edit the value of Timbre/Track parameters such as MIDI Channel or Status

Some parameters can't be edited while notes are playing, either locally or from MIDI. If the damper pedal is held down, or if its calibration is incorrect, notes may be sustaining even if they aren't audible.

- Are you using a damper pedal with a polarity that does not match the **Damper Polarity** setting (Global P2: Controllers/Scales)? For more information, see "Damper Polarity," on page 781 of the Parameter Guide.
- In some cases, this problem can be solved by executing the page menu command **Half Damper Calibration** (Global P0: Basic Setup). For more information, see "Half Damper Calibration," on page 806 of the Parameter Guide.

### No beep sounds when you touch the LCD screen

Check the **Beep Enable** check box (Global P0: Basic Setup). For more information, see "Sounding a beep when you press the LCD screen" on page 169.

---

## Audio input and output

---

### No sound

Are connections made correctly to your amp, mixer, or headphones? For more information, see "Connections" on page 21.

Is the connected amp or mixer powered-on, and is its volume raised?

Is Local Control turned on?

- In Global P1: MIDI, check the **Local Control On** check box.

Is the MAIN VOLUME knob raised? See "MAIN VOLUME knob" on page 1.

Is the MASTER slider raised? (See "Master Volume" on page 24 of the Parameter Guide.)

Could MASTER VOLUME have been assigned to the ASSIGNABLE PEDAL, and the pedal set in the minimum position?

Could the vector joystick be controlling the volume?

- Try moving the vector joystick as you play.

If there is no sound from the AUDIO OUTPUT (INDIVIDUAL) 1–4 jacks, make sure that **Bus Select** or **Bus Sel.** (Bus Select) following the insert effect is set to 1–4, or 1/2–3/4.

Does the "Samples Not Loaded" message appear? If so, is the required sample data loaded?

If a specific timbre doesn't sound in Combination mode, is its Play/Mute button set to Play? Alternatively, are all Solo settings turned off? (If the Solo button is blinking, this means that at least one timbre is being soloed.)

If a specific track doesn't sound in Sequencer mode, is its Play/Rec/Mute button set to Play? Alternatively, are all Solo settings turned off? (If the Solo button is blinking, this means that at least one track is being soloed.)

Make sure that the **Status** is INT or BTH. (See "Preparations for recording" on page 82.)

Are the Key Zone and Velocity Zone set so that sound will be produced when you play?

Is the Global **System Clock** set to S/P DIF? If this is the case, and a valid 48kHz S/P DIF source is not connected, then the KRONOS outputs will be silent.

### Can't output sound from an audio CD

Make sure that you have selected the Disk mode Play Audio CD page or Sampling mode.

Is the output of the audio CD being input correctly?

- In the Disk mode Play Audio CD Page, make the appropriate settings for **Bus Select (IFX/Indiv.)** and **Level**. Alternatively, in the Sampling mode P5: Audio CD– Ripping page, make the appropriate settings for **Bus Select (IFX/Indiv.)** and **Level**.
- Is the **Drive Select** setting correct?

Is the **MAIN VOLUME knob** raised?

If you created the CD using the KRONOS, has the CD been finalized?

- A CD-R/RW disc created using the Disk mode Make Audio CD page cannot be played until you also finalize the disc. Use the page menu command **Finalize Audio CD** to finalize the disc. For more information, see "Finalize Audio CD" on page 855 of the Parameter Guide.

---

### Audio inputs don't work properly

Are the appropriate sources connected to the analog, S/P DIF, or USB inputs?

If there is no sound in Sampling mode, check that **Bus Select (IFX/Indiv.)**, and **Level** are set correctly in the Sampling P0: Recording– Audio Input page.

Alternatively, is SAMPLING REC turned on?

If there is no sound in Program, Combination, and Sequencer modes, check that **Bus Select (IFX/Indiv.)**, and **Level** are set correctly in Global P0: Basic Setup– Audio page; or in the P0: Sampling pages of Program, Combination, or Sequencer modes.

On the 0–8: Audio Input/Sampling page, is the Use Global Setting parameter set correctly?

### Analog audio inputs

If you are using AUDIO INPUT 1 and/or 2, make sure that the AUDIO INPUT LEVEL knobs are raised.

If you are using AUDIO INPUT 1 and/or 2, are the MIC/LINE switches set appropriately?

### S/P DIF input

If you are using the S/P DIF IN, is the input signal in an unsupported format?

- Please make sure that the connected digital audio device is compatible with CP-1201 or S/P DIF. ADAT format is not supported.

Is the S/P DIF device set to a compatible sample rate?

- Only 48 kHz sampling rate is supported. If the connected device is using an unsupported rate, you may hear noise, and the message “CLOCK ERROR!” may appear.

### Noise or distortion on audio inputs or recorded sound

If you are recording from audio inputs 1 and/or 2, are the AUDIO INPUT LEVEL knobs and **Recording Level** settings appropriate?

- If **Recording Level** shows “ADC OVERLOAD !,” adjust the LEVEL knob. If “CLIP !” is displayed, adjust the **Recording Level** slider.

If you are recording from the S/P DIF or USB inputs, are the level of the output device and the **Recording Level** set appropriately?

- If “CLIP !” appears, adjust the **Recording Level** slider.

Is the system clock set correctly?

- If cyclic click noise is occurring, check that you have selected the **System Clock** that is being input.

### After sampling or sample edits

After a sample edit has been executed, or after a stereo sample has been recorded, a small noise may be heard. This has no effect on the audio data that was edited or sampled.

### Noise or oscillation with effects

When using an effect on external audio inputs, oscillation may occur depending on the type of effect or on the parameter settings. Please adjust the input level, output level, and effect parameters. You need to be particularly careful when using a high-gain effect.

When using the MIDI/Tempo Sync function to control the delay time of an effect, noise may occur in the delay sound. This noise is due to discontinuities in the delay sound, and is not a malfunction.

Some effects, such as 023: Stereo Analog Record, generate noise intentionally. It is also possible to create oscillation using a filter with resonance. These are not malfunctions.

### Disk access noise is heard in the analog outputs

Check that the electrical grounding is correct for the KRONOS and all connected audio equipment, and remove any ground loops.

### Notes do not stop

In Program P1: Basic/Vector, select the Program Basic page, make sure that the **Hold** check box is unchecked.

Could you have used Tone Adjust to turn **Hold** on?

In Global P2: Controllers/Scales, make sure that **Damper Polarity** or **Foot Switch Polarity** is set correctly.

### Sound fades in and out

If an option is in demo mode, any sound which uses the option will fade in and out.

## Programs and Combinations

### Program or Combination does not play correctly

#### Preloaded programs don't play correctly.

Does the “Samples Not Loaded” message appear? If so, is the required sample data loaded?

- Use the **Load required samples** menu command on the P0:Play page. For more information, see “Load required samples” on page 149 of the Parameter Guide.
- Alternatively, in Global mode, use the Auto-Load KSC feature to load the PRELOAD.KSC file. For more information, see “Automatically loading sample data” on page 174.

### Settings for oscillator 2 are not displayed

Make sure that the **Oscillator Mode** (Program P1: Basic/Vector) parameter is set to Double.

### EXi2-related settings are not displayed

On the Basic/Vector page, is there an EXi instrument selected for EXi2? For more information, see “EXi 2 Instrument Type” on page 171 of the Parameter Guide.

### Reverse can't be enabled

If a Multisample or Drumsample is loaded using Virtual Memory, Reverse cannot be enabled.

- Use the Global P0: Sample Management page to change the Multisample or Drumsample's Load Method to RAM.

---

### EXi programs don't play correctly in a Combination.

Does the Timbre's number have a gray background color, instead of blue? And, does [Inactive] appear after the Program name in the Selected Timbre Info?

- The Programs in the Combination are asking for more than the maximum available EXi fixed resources. Remove one or more of the EXi Programs which uses fixed resources.  
For more information, see "CX-3 & other EXi: Limitations on EXi fixed resources" on page 424 of the Parameter Guide.

---

### Combination does not play correctly after loading from disk

In the dialog box when you saved the data, did you check the items that you wanted to save?

Are the bank/numbers of the programs used by the combination the same as when the combination was created?

- If you have switched program banks, you can use the **Change all bank references** menu command to change the program bank for each timbre of a combination. For more information, see "Change all bank references" on page 806 of the Parameter Guide.

---

## Songs

---

### Song does not play correctly after being loaded

In the dialog box when you saved the data, did you check all of the items that you wanted to save?

Are the Programs used by the Song the same as when the song was created?

- If you have switched Program banks, you can use the page menu command **Change all bank references** to change the Program bank for each track of a Song. For more information, see "Change all bank references" on page 806 of the Parameter Guide.
- When saving the song, it is best to use **Save All** or **Save PCG & SEQ** so that the programs are saved together with the song. Then when loading, load both the .PCG and the .SEQ data.

Have you loaded the multisamples and samples used by the program?

---

### Audio tracks don't play

The audio files for the Song must be stored within a directory at the same directory level as the .SNG file, and that directory must be have the same name as the .SNG file, followed by "\_A" (for "Audio"). For instance, if the .SNG file is named WAMAZART.SNG, its audio folder must be named WAMAZART\_A. If you move or rename the .SNG file, make sure to move or rename the main audio folder as well.

---

### Can't write a Program

You can't write HD-1 Programs into an EXi bank, or EXi Programs into an HD-1 bank. If desired, you can use the Global mode page menu command **Set Program Bank Type** to change the type of each bank, so that it will accommodate the desired type of Programs. For more information, see "Changing the Program Bank Types" on page 31.

---

### Samples don't play from the correct keys

Is **Portamento** enabled? When **Portamento** glides between two notes which are mapped to different samples, the system always plays the higher sample and then glides to the target pitch. If a Multisample contains distinct samples mapped to different key ranges—for instance, loops or sound effects—this can produce unexpected results.

- To prevent this from occurring, turn off **Portamento**.

---

### Pads don't play chords

Is **Chord Mode** enabled? When **Chord Mode** is enabled, the on-screen pads (or MIDI input controlling the pads) will select chords to be triggered from the keyboard, as opposed to playing the chords directly.

- To prevent this from occurring, turn off **Chord Mode** for the Program, Combination Timbres, or Song Tracks.

---

If the folder containing the WAVE files for the song you loaded has the wrong name, the icon is shown in gray. Could you have moved or renamed the folder?

---

### Loading OASYS-format Songs

The KRONOS can play Songs created on the Korg OASYS. However, the name of the audio directory will need to be changed slightly.

OASYS files were limited to 8 characters, and so the name of the audio file directory was typically abbreviated. For instance, if the .SNG file was named WAMAZART.SNG, the OASYS audio folder would be named WAMOZA\_A.

Before you load an OASYS .SNG file, edit the name of the directory so that it matches the KRONOS standard: the same name as the .SNG file, followed by "\_A" (for "Audio"). In the case above, you'd rename "WAMOZA\_A" to "WAMAZART\_A."

---

### Playback does not start when you press the SEQUENCER START/STOP switch

Is the **MIDI Clock** (Global P1: MIDI) set to Internal or Auto?

---

### Can't record in Sequencer mode

Did you use **Track Select** to select the MIDI track or audio track that you want to record?

Is the Memory Protect **Song** check box (Global P0) unchecked?

Is the **MIDI Clock** (Global P1: MIDI) set to Internal or Auto?

---

### EXi programs don't play correctly in a Song.

Does the Track's number have a gray background color, instead of blue? And, does [Inactive] appear after the Program name in the Selected Track Info?

- The Programs in the Song are asking for more than the maximum available EXi fixed resources. Remove one or more of the EXi Programs which uses fixed resources.

For more information, see "CX-3 & other EXi: Limitations on EXi fixed resources" on page 424 of the Parameter Guide.

---

### KARMA doesn't record properly after using "Copy From Combi"

Is **Multi REC** (Sequencer P0: Play/REC) checked?

Are the settings in the Copy From Combination dialog box correct?

- In the Copy From Combination dialog box, check the **Multi REC standby** option before you execute the copy. This will cause the settings to be adjusted automatically.

---

### Can't record your performance using Tone Adjust

Changes you make using Tone Adjust are recorded as system exclusive data. Did you check the Global mode MIDI Filter **Enable Exclusive** check box?

---

### RPPR does not start

Is the Sequencer P0: Play/REC **RPPR** setting checked? (See "Using RPPR (Realtime Pattern Play/Record)" on page 112.)

Are **Assign**, **Pattern Select**, and **Track** set correctly? See "Using RPPR (Realtime Pattern Play/Record)" on page 112.

Is the **MIDI Clock** (Global P1: MIDI) parameter set to Internal, Auto MIDI, or Auto USB? See "MIDI Clock (MIDI Clock Source)" on page 773 of the Parameter Guide.

---

## Set Lists

---

### COMPARE doesn't affect Control Surface

When you're in Set List mode, the COMPARE button acts on edits to the Set List, such as the sounds selected for each Slot, hold times, comments, and so on.

Control Surface edits in Set List mode apply to the Slot's Program, Combination, or Song, and not to the Set List itself. This means that pressing COMPARE in Set List mode will not revert such edits.

To revert Control Surface edits made in Set List mode:

#### 1. Go to the sound's native mode.

For instance, if the Slot contains a Program, go to Program mode.

---

### Can't record on an audio track

Have you unchecked the Memory Protect **Internal HDD Save** check box (Global P0)?

Have you set **Track Select** to the audio track you want to record?

If you want to perform multi-track recording (**Multi REC** checked), is **Play/Rec/Mute** set to REC?

Are the audio input settings correct?

- Please see Audio input and output, and Audio inputs don't work properly.

Is there space remaining on the disk?

- Delete unwanted WAVE files.
- Save a copy of important WAVE files on external media, and then delete them from the disk.

Are the **REC Source** settings correct?

A "File already exists" message appears, and you can't record.

- In the P0: Play/REC— Preference page, change the name of the WAVE file that you're going to record.
- Delete the files in the TEMP folder.

---

### Can't import WAVE files into a region of an audio track

In the Import Region/WAVE dialog box, you selected a WAVE file but can't press the OK button.

- Only 44.1 kHz and 48 kHz WAVE files can be imported.
- You can only directly import WAVE files from the internal disk. To use files from CDs or external USB devices, you must first copy them to the internal disk, and then import the copied file into the Song.

---

### Noise in sampled audio

If you use COMPARE or change the EXi Instrument type in an EXi Program while recording a sample, this can cause a glitch in the resulting sample.

#### 2. Press COMPARE.

The Control Surface edits will be reverted. You can then return to Set List mode if desired.

## Sampling

---

### Can't sample

Are the audio input settings correct?

- See “Audio inputs don’t work properly” on page 260

Is there enough free RAM memory for sampling?

Is there free space in memory? For more information, see “0–1f: Free Sample Memory/Locations” on page 686 of the Parameter Guide, and “0–9: Media Information” on page 822 of the Parameter Guide.

- In order to sample to RAM, you must allocate sufficient space for sampling.
- If you are sampling to disk, select a different disk. For more information, see “Select Directory/File for Sample To Disk” on page 151 of the Parameter Guide.
- Delete unneeded samples. For more information, see “Delete Sample” on page 727 of the Parameter Guide, and “0–4: Sample Management” on page 766 of the Parameter Guide.
- Save important samples to disk, and then delete them from memory.

If you’re sampling to the internal disk, did you uncheck the Memory Protect “Internal HDD Save” dialog box? (Global P0)

If you’re sampling to external USB storage media, did you select recordable media?

Is the **Trigger** setting correct? For more information, see “Trigger” on page 19 of the Parameter Guide.

In Sampling mode, if **Resample** is set to Auto, has the sample to be resampled been assigned to the keyboard, and the **Key** parameter set correctly? See “Applying an insert effect to a sample and resampling the result” on page 146.

Is the **Source Bus** setting correct?

If a “buffer overrun error occurred” message is displayed frequently when you are sampling to disk, execute the page menu command **Check Medium** (Disk– Utility page) to find and correct any errors on the selected MS-DOS format media. For more information, see “Check Medium” on page 854 of the Parameter Guide.

### A stereo sample can't be played in stereo

Is the multisample actually stereo?

- Execute the page menu command “MS Mono To Stereo” to convert the multisample to stereo. For more information, see “MS Mono To Stereo/MS Stereo To Mono (Change Multisample Type)” on page 731 of the Parameter Guide

Is the sample name assigned correctly? (See “Stereo” on page 683 of the Parameter Guide.)

### Volume of a recorded sample is too low/too high

Samples that you resampled at a **Recording Level** of approximately 0.0 (dB) have a lower volume than when you resampled them.

- Did you turn on the **Auto +12 dB On** setting when you resampled? See “Auto +12 dB On” on page 138.
- If you resampled with **Auto +12 dB On** turned off, turn on **+12 dB** (Sampling mode Loop Edit page) for that sample.

### Song or CD playback stops temporarily when you sample

Is **Auto Optimize RAM** checked?

- If this is checked, RAM will be optimized automatically when sampling ends, causing the sound to stop at that point. If a song is being played in Sequencer mode or if a CD is being played back, the playback will stop.

### AIFF file can't be loaded

Make sure that the file suffix is three characters: .AIF. Some computer applications create files with a four character suffix, .AIFF, which is not recognized by the KRONOS.

### Time lag between pressing the SAMPLING REC switch and entering sampling-standby mode

The length of time until you enter sampling-standby mode will depend on the state of the free space on the disk (i.e., whether the free space is continuous or fragmented).

- When sampling to the disk, pressing the SAMPLING REC switch will cause the amount of space specified by **Sample Time** to be allocated within the disk.
- Set **Sample Time** only slightly longer than the length that you will actually sample; avoid specifying an excessively long sample time.

### Snap/click noise in recorded sample

Some things can cause the system to pause briefly in the middle of recording a sample, creating a snap or click noise. These include pressing the COMPARE button, changing the EXi type parameters on the EXi Program P4: Program Basic page, or receiving a System Exclusive bulk dump. Avoid these while sampling.



---

## KARMA

---

### KARMA does not start

Is the KARMA ON/OFF switch turned on (lit)?

If a KARMA module does not start in Combination or Sequencer mode, is the **Run Check Box** checked for that module? Also, are the **Input Channel** and **Output Channel** settings appropriate?

Is **MIDI Clock** (Global P1: MIDI) set to Internal or Auto?

In the Global P0: Basic Setup page, could **All KARMA Off** be checked?

Is the KARMA LINKED LED lit? If so, KARMA is linked with the Drum Track. Start the Drum Track to trigger KARMA. For more information, see “Using KARMA and the Drum Track together” on page 255.

---

## Drum Track

---

### Drum Track does not start

Is the DRUM TRACK ON/OFF switch turned on (lit)?

Is the DRUM TRACK [ON/OFF] switch blinking? Trigger Mode is set to Wait KBD Trig. The drum track pattern will start when you play the keyboard, or when a note-on is received via MIDI. See “Turning the Drum Track on and off” on page 252.

Does the current Drum Track pattern contain data? If there’s no data in the pattern, the Drum Track won’t play.

If you’re in Combination mode, is the Output Channel setting appropriate? See “Using the Drum Track in Combination mode” on page 252.

If you’re in Sequencer mode, are the Input Channel and Output Channel settings appropriate? See “Drum Track settings in Sequencer mode” on page 254.

Is the MIDI Clock parameter set correctly? See “MIDI Clock synchronization” on page 170.

In the Global P0: Basic Setup page, is Drum Track Off checked? See “Globally disabling KARMA and the Drum Track” on page 169.

If the Drum Track stops when you switch the KARMA Master scene, have you checked the DT Run (Drum Track Run) check box of the KARMA Master scene?

---

## Vector

---

### Can’t control the volume

Is the **Enable Volume Control** check box checked?

Is the Combination or Sequencer mode **VJS Assign** setting appropriate?

Have you checked the **Enable Program Vector Volume** check box so that the volume control of a program can be reproduced in Combination or Sequencer mode?

In Combination or Sequencer mode, are the **Enable Combi Vector CC** or **Enable Song Vector CC** check boxes checked?

Have you checked the **Enable Program Vector CC** check box so that the CC control of a program can be reproduced in Combination or Sequencer mode?

---

### CC control does not work

Is the **Enable CC Control** check box checked?

Are the **VJS X mode** and **VJS Y mode** settings appropriate?

---

### An envelope doesn’t operate according to its settings

Is the front panel vector joystick set to the center position? The operation of the envelope is offset by the position of the vector joystick.

- Hold down the RESET CONTROLS button and move the vector joystick to reset it to the center.

---

## Drum Kits

---

### The Drumsample’s pitch does not change

You have left the **Assign** check box unchecked, and want to play the Drumsample at the adjacent right a semitone lower, but the pitch does not change.

- If you have selected a drum program in Program mode, and then want to edit the drum kit in Global mode, go to the Program P2: Edit-Pitch, OSC1 Pitch Mod. page and set **Pitch Slope** to +1.0 before you enter Global mode.

---

## Wave Sequences

---

### The wave sequence does not advance

Is the **Run** check box checked?

### Swing does not work properly

Is the wave sequence's **Mode** set to Tempo?

Is the wave sequence's **Swing Resolution** set appropriately?

---

## Effects

---

### Effects are not applied

Have you selected effect program 000?

- Select an effect other than 000: No Effect for **IFX1–12**, **MXF 1, 2** or **TFX 1, 2**.

Are the Effect Global SW **IFX 1–12 Off**, **MXF1&2 Off**, or **TFX1&2 Off** (Global P0: Basic Setup page) settings checked?

If you are in Combination or Sequencer mode and master effects are not applied when you raise the timbre/track **Send1** or **Send2** settings, does **Return 1** or **Return 2** from the master effect need to be raised?

Alternatively, have **Send 1** or **Send 2** for each oscillator of the program used by the timbre/track been lowered?

*Note:* The actual send level is determined by multiplying the send setting of each oscillator in the program with the send setting of the timbre/track.

Have you routed the output to an insert effect?

---

## MIDI

---

### The KRONOS does not respond at all to incoming MIDI data

Are all MIDI cables connected correctly?

Is the MIDI data being received on the channel on which it is being transmitted?

### The KRONOS does not respond correctly to incoming MIDI data

Are the Global P1: MIDI settings **MIDI Filter Enable**, **Program Change**, **Enable Bank Change**, **Enable Control Change**, **Enable AfterTouch**, and **Enable Exclusive** each checked?

Does the KRONOS support the types of messages that are being sent to it?

### Incorrect response to program change messages

Is the **Bank Map** setting correct?

---

## Disks, CDs, and USB Media

---

### Internal disk and external USB devices

#### External USB devices are not recognized

Has the drive been formatted?

Is the external device connected correctly?

Have you waited a few seconds for newly-connected USB devices to be recognized?

#### “Error in writing to medium” occurs frequently when saving data

Use the page menu command **Check Medium** (Disk–Utility page) to detect and repair errors on the media. For more information, see “Check Medium” on page 854 of the Parameter Guide.

#### Save or Load operations cannot be completed

If there is no more room on the internal disk (the Disk mode Media Info page's **Free Space** parameter will show zero free space), then Write, Save, or Load operations may not be completed.

### CD-R/RW

#### CD-R/RW drive is not recognized, or Can't write

Was the drive subjected to physical shock or vibration while data is being written?

If you are unable to save data such as PCG or SNG files, has the disc been formatted?

If you are writing audio tracks to create an audio CD, it is not necessary to format the disc.

Are you using the recommended media for your drive?

If you are writing from an external USB drive to CD-R/RW, it is possible that the transfer speed is insufficient.

- Writing may be successful if you lower the writing speed.
- Writing may be successful if you first copy the data from the external USB drive to the internal disk, and then execute the writing operation from the internal disk.

Are you using blank media?

---

- If using CD-R, please use new media. If using CD-RW, use the page menu command **Erase CD-RW** (Disk– Make Audio CD) to erase the contents of the media before you execute Save.

### A KRONOS CD-R/RW is not recognized by an external device

A CD-R/RW saved or copied on the KRONOS using packet writing is not recognized on a computer.

- If you install a UDF version 1.5 compatible UDF reader or packet writing software on your computer, it will be possible to recognize the disc.
- In the case of a CD-R, it may be possible to make the disc be recognized by executing the page menu command **Convert to ISO9660 Format** (Disk– Utility page) to convert the disc to ISO9660 format. However depending on the state in which the disc was saved, it may be converted into ISO9660 level 3 format, and may still not be recognized. In this case if you install ISO9660 level 3 compatible reader software or packet writing software on your computer, it will be possible to recognize the disc.

A CD-R/RW that was saved or copied on the KRONOS using packet writing is not recognized by the TRITON/TRITON pro/TRITON proX/ TRITON-Rack/TRITON Le.

- These models do not support UDF version 1.5, and therefore will not recognize such a disc.
- In the case of a CD-R, it may be possible to make the disc be recognized by executing the page menu command **Convert to ISO9660 Format** (Disk– Utility page) to convert the disc to ISO9660 format. However depending on the state in which the disc was saved, it may be converted into ISO9660 level 3 format, and may still not be recognized.

### Can't write audio tracks

Additional writing is not possible on a CD-R/RW disc that has been finalized.

### Can't play back the disc on an audio CD player

Did you finalize the disc?

- If you want to finalize the disc after writing additional data, check the **Execute finalize too** check box when executing the page menu command “Write to CD” (Disk– Make Audio CD), so that the disc will be

finalized. For more information, see “Write to CD” on page 855 of the Parameter Guide.

- If you only want to finalize the disc, select the page menu command **Finalize Audio CD** (Disk– Make Audio CD), and press the OK button to finalize the disc. For more information, see “Finalize Audio CD” on page 855 of the Parameter Guide.

Are you using CD-R media?

- Since some CD players are unable to play CD-RW media, we recommend that you use CD-R media.

Have you tried using a different type of media?

- Some CD-R/RW media cannot be played by some CD players. You may be able to play back successfully by using a different type (brand) of CD-R/RW media.

---

## WAVE files

### Can't load

Is the WAVE file in a format that the KRONOS can load?

- Only 48 kHz or 44.1 kHz WAVE files can be inserted into an audio track in a Song, or into the Track CD List.

### Can't preview

Is the WAVE file in a format that the KRONOS can load?

- Only 48 kHz or 44.1 kHz WAVE files can be previewed by pressing the Play button in the directory window.

---

## Some Global settings are stored automatically, and not saved to PCG files

Some settings in Global mode are stored automatically, and are not saved in the Global section of PCG files. If you wish to duplicate or restore these settings, you will need to do so by editing the parameters manually.

This includes:

- The Auto Power-Off parameter (for those models which support this function)
- Fan Control setting

As well as all settings on the following pages:

- 0–3: KSC Auto-Load
- 0–5: Network

---

## Other problems

---

### Date and time are incorrect

Saved files or sampled WAVE files have an incorrect date or time.

- Use the page menu command **Set Date/Time** (Disk– Utility page) to set the current date and time. For more information, see “Setting the date and time” on page 209.

Does the message “The clock battery voltage is low. Please replace the battery, and set the date and time in Disk mode” appear? If so, the calendar backup battery needs to be replaced. Your Korg Distributor can help you find a service center to replace the battery.

## Error and confirmation messages

---

### A (ADC–Are You Sure)

#### ADC Overload

**Meaning:** If the **ADC OVERLOAD!** indication appears above the Recording Level bar, the signal is distorting because of an overload at the AUDIO INPUT stage. To solve this problem:

- Adjust the MIC/LINE gain select switch, the LEVEL knob, or the output level of your external audio source.

#### Are you sure?

**Meaning:** This message asks you to confirm execution. To execute press the OK button. To cancel, press the Cancel button.

### B (Buffer)

#### Buffer overrun error occurred

**Meaning:** When sampling to external USB media, the processing could not keep up with the sampling. To solve this problem:

- Execute the Disk Utility page menu command **Check Medium**. Then try the sampling operation again. If this does not resolve the problem, copy several files from that media to other media, delete those files, and then try the sampling operation again.

*Note:* Sampling may not be possible because of the media you're using. Please use the recommended types of media.

*Note:* If the “Buffer overrun error occurred” error message appears, the data up to the point the error occurred has been sampled, but the data at the point the error occurred may not play back correctly.

#### Buffer underrun error occurred

**Meaning:** When playing back a WAVE file from external USB media, the data could not be read fast enough for playback processing.

- Copy the file you want to play into another folder, and then execute the operation again.

*Note:* Playback may not be possible because of the media you're using. Please use the recommended types of media (see “Types of media supported by the KRONOS” on page 280).

### C (Can't calibrate–Completed)

#### Can't calibrate

**Meaning:** Calibration could not be performed correctly.

- Try again.

#### Can't execute Audio Track recording

**Meaning:** You attempted to record audio tracks when **Recording Setup** is set to Loop All Tracks

- You cannot perform audio track recording with Loop All Tracks. Choose a different Recording Setup, and try recording again.

**Meaning:** You attempted to record audio tracks with the Global mode **MIDI Clock** set to External MIDI/USB or Auto MIDI/USB, and an external device (such as a computer or another MIDI device) is acting as the MIDI clock master

- You cannot perform audio track recording when an external device is the MIDI clock master. Set **MIDI Clock** to Internal so that the KRONOS is the MIDI clock master.

**Meaning:** If the Global mode Memory Protect parameter **Internal HDD Save** is checked, writing to the internal disk is prohibited. This error message will appear if you attempt to record on audio tracks in this state.

- Uncheck the **Internal HDD Save** item, and try the recording again.

#### Can't insert event in stereo track

**Meaning:** In Sequencer mode, you were performing audio event editing on an audio track that is assigned as a stereo pair, and were unable to insert an audio event because the paired track contained an audio event.

- Delete the unwanted audio event from the paired audio track, and then insert the desired event.

#### Can't load divided PCG file

**Meaning:** The page menu command **Load PCG (RAM) and Samples** cannot be performed on a divided PCG file.

#### Can't open pattern Continue?

**Meaning:** When you finished recording, it was not possible to allocate enough memory to open the pattern that was Put into the track. (When it must be opened automatically.) If you press the OK button, the pattern data will be deleted, and the recorded or edited content will be saved. If you press the Cancel button, the recorded content will be discarded.

---

**CLIP!**

**Meaning:** The “CLIP!” indication will appear if the signal level exceeds 0 dB.

- The signal being sampled or recorded to an audio track has overloaded; use the **Recording Level** slider to adjust the level.

*Note:* When using the analog audio inputs, you will obtain the widest possible dynamic range if you adjust the MIC/LINE gain select switch and the LEVEL knobs as high as possible without allowing “ADC OVERLOAD!” to appear. In addition, you should set **Level** (0–2a) to 127, and adjust **Recording Level** as high as possible without allowing “CLIP!” to appear.

---

**CLOCK ERROR!**

**Meaning:** The Global **System Clock** is set to S/P DIF, but the clock at the digital input is not being detected correctly.

- Whenever you use digital audio connections, make sure that all connected systems are set so that there is one and only one word clock master. You can set the word clock for the KRONOS using the Global page **System Clock**

---

**D (Destination–Disk)**

---

**Destination and source are identical**

**Meaning:** When copying or bouncing, the same song, track or pattern was selected for both the source and destination. To solve this problem:

- Select a different song, track, or pattern for the source and destination.

---

**Destination from-measure within the limits of source**

**Meaning:** When executing the Move Measure command for all tracks or within the same track, the specified destination measure is within the source range. To solve this problem:

- Set a destination measure that is outside of the source range.

---

**Destination is empty**

**Meaning:** When editing, the track or pattern that was specified as the destination contains no musical data. To solve this problem:

- Select a track or pattern that contains musical data.

---

**Destination measure is empty**

**Meaning:** The measure that was specified as the destination contains no data.

- Specify a destination measure that contains data.

---

**Destination multisample already exists**

**Meaning:** A multisample already exists at the destination (save location) multisample.

parameter. For more information, see “System Clock” on page 756 of the Parameter Guide.

- Make sure that your external device is correctly transmitting a digital signal.
- Make sure that the sample rate of the external device is 48 kHz.
- Make sure that there is no problem with the cable.

---

**Completed**

**Meaning:** Execution of the command ended normally.

---

**Could not execute Capture Random Seed, because the selected Start Seed is assigned as an RTParam**

**Meaning:** If the KARMA module's “Start Seed” parameter has been assigned as a performance realtime parameter, this message will appear when you attempt to execute the Capture Random Seed command; the command cannot be executed. (Press the OK button to close the message.)

- In the Perf RTP page, cancel the performance realtime parameter assignment for Start Seed.

- Either delete the multisample at the destination (save location), or change the save destination multisample number.

---

**Destination multisample and source multisample are identical**

**Meaning:** The same multisample is selected for the source and destination.

- Select different multisamples for the source and destination.

---

**Destination sample already exists**

**Meaning:** A sample already exists at the destination (save location).

- Either delete the sample at the destination (save location), or change the save destination sample number.

---

**Destination sample data used in source sample Can't overwrite**

**Meaning:** Since the sample data at the destination (save location) is also used by the source sample, it cannot be overwritten.

- Without using Overwrite, specify a different sample for the destination (save location).

---

**Destination sample is empty**

**Meaning:** The sample for editing is empty.

---

### Directory is not empty Cleanup directory Are you sure?

**Meaning:** When deleting a directory, files or directories exist within that directory.

- Press the OK button to delete all files and/or directories within that directory.

---

### Disc full

**Meaning:** When using the **Write to CD** command in the Disk mode Make Audio CD page, there is insufficient space remaining on the CD-R/RW for the data to be written.

---

## E (Error–Exceeded)

---

### Error in formatting medium

**Meaning:** An error occurred while performing a physical format (full format) or high-level format (quick format) of the media. To solve this problem:

- Use other media.

**Meaning:** When executing the Disk mode Utility page menu command **Convert to ISO9660 Format**, an error occurred while rewriting the UDF area. To solve this problem:

- Use other media.

---

### Error in mount process. Please backup files

**Meaning:** An error was found on a UDF-format CD-R/RW or DVD-R/RW disk. To solve this problem:

- Make a backup of the data, and stop using the disk which caused the error.

---

### Error in reading from medium

**Meaning:** An error occurred while reading data from media. This error may also appear when data is being written to media by a Save or Copy operation. To solve this problem:

- Execute the reading operation once again. If the same error occurs, it is possible that the data on the disk has been damaged.

---

### Error in writing to medium

**Meaning:** A verification error occurred while writing data to the internal disk or USB storage device. To solve this problem:

- Use the Disk Utility page menu command **Check Medium** to detect and repair errors on the media. For more information, see “Check Medium” on page 854 of the Parameter Guide.
- It is possible that the media has been physically damaged. Try another storage device, and avoid using the one that produced the error.

- Either write to other media, or remove unneeded tracks.

---

### Disk not formatted

**Meaning:** When you attempted to perform a high-level format (quick format) of media, the media had not been physically formatted yet. To solve this problem:

- Use the Disk mode Utility page menu command **Format** to physically format the media (full format).

---

### Error: invalid option file

**Meaning:** While preparing to install an option (such as an EXs), the system has detected corrupted data in the files to be installed. To solve this problem:

- Copy the file to the USB media again, or if that fails, download the data again.

---

### Error loading Drumsamples.

### Error loading Multisamples.

**Meaning:** When executing **Change load method**, a sample could not be loaded correctly.

---

### Error: not enough disk space for the installation

**Meaning:** While preparing to install an option (such as an EXs), the system has determined that the internal SSD is too full. To solve this problem:

- Remove data from the SSD, backing it up to USB media, in order to free up space.

---

### Error unloading Drumsamples.

### Error unloading Multisamples.

### Error unloading Exs

### Error unloading RAM

**Meaning:** When executing **Change load method** or **Unload all data from selected bank**, a sample could not be unloaded correctly.

---

### Exceeded 1000 measure limit

**Meaning:** The length of the Standard MIDI file being loaded would exceed the maximum of 1,000 measures.

---

### Exceeded 16 Programs

**Meaning:** You exceeded 16 programs while performing Advanced Conversion Load. When an AKAI Program is loaded, it will be converted into multiple programs and one combination according to its structure. At this time, the maximum number of KRONOS programs resulting from

this conversion is limited to 16, which is the maximum number of programs that can be used in a combination. To solve this problem:

- Load the AKAI programs individually, and edit them on the KRONOS.

- Instead of using Advanced Conversion Load, load the multisamples or samples, and edit them on the KRONOS.

---

## F (File–Front)

---

### Failed. Source device not found Failed. Bad install.info - invalid SOURCE Failed. Bad install.info - VERSION missing Failed. Bad install.info - CRC fails

**Meaning:** When executing the Global mode **Update System Software** command, these messages will appear if the update could not be performed correctly. To solve this problem:

- Try the update again. Alternatively, try again using another CD/DVD or USB flash memory.

---

### File already exists

**Meaning:** When executing a **Create Directory** or **File Rename** operation, a directory or file of the same name already exists on the disk.

Or, when using the Disk mode **Copy** command without using wildcards, the copy destination contained a file with the same name as the copy source.

Or, when using the Disk mode **Save Sampling Data** command (for All, All Multisamples, All Samples, or One Multisample), a directory already existed on the disk with the same name as the directory which would be created by the save operation.

Or, when sampling to disk, an identically-named file exists in the destination directory.

To solve any of these problems:

- Either delete the existing directory or file, or specify a different name.

**Meaning:** When recording an audio track, an identically-named WAVE file exists in the directory.

- Either delete the existing file, or use the Sequencer P0–Preference page to specify a different name.

**Meaning:** If an audio track recorded before the last power-off was not saved as an .SNG file, the following message will appear when you turn on the power.

/TEMP folder detected.

This folder may contain unsaved WAVE files from a previous audio track recording session.

Do you want to restore the /TEMP folder, or delete it from the disk?

[Restore] [Delete]

If you choose Restore, a folder named TEMP will remain on the internal disk. If you then record audio tracks in this state, and use the default name in the Preference page, the name may be identical to the already-existing WAVE file, causing this message to appear.

- Specify a different name. (Sequencer P0: Play/Rec Preference page)

- Use the Disk Utility page menu **Delete** command to delete the TEMP folder.

**Meaning:** When saving a .SNG file, a separate directory is created for the Song’s audio files. The directory’s name consists of the .SNG file name followed by “\_A” (for “Audio”). If this error appears when saving a .SNG file, it can mean that a directory with this name already exists. To solve this problem:

- Change the .SNG file name to something other than the name of an existing directory, and then save the data again.

---

### File contains unsupported data

**Meaning:** You attempted to load an AIFF, WAVE, or KSF file that was in a format not supported by the KRONOS.

- In the case of a AIFF or WAVE file, use a computer (if possible) to convert the file into a format that is supported on the KRONOS, and then load it.

---

### File is read-only protected

**Meaning:** You attempted to write to a file or to delete a file that had a read-only attribute.

**Meaning:** You attempted to save a file to media that contained a read-only file of the same name.

- Save the file with a different name.

**Meaning:** You attempted to save a file or directory in a Locked directory.

- Use the page menu command **Lock/Unlock** to unlock the directory.

---

### File name conflicts

**Meaning:** When saving a .SNG file, the directory in which the WAVE file used by the region is to be saved already contains a directory with the same name as the .SNG file, followed by “\_A,” and that directory contains an identically-named WAVE file.

**Meaning:** When saving a SNG file, the WAVE files being saved are such that some of them would have the same filenames as files in the save-destination.

- Using the text edit field shown below “Rename,” edit the name of the WAVE file being saved so that it does not conflict. Then press “OK.” If you press “Cancel,” that WAVE will not be saved, so you should normally edit the name and save the data.

---

### File unavailable

**Meaning:** You attempted to load or open a file whose format was incorrect.



---

### File/path not found

**Meaning:** When loading a sample file in Disk mode, executing the **Delete** command, or selecting a disk or directory in a dialog box, the specified file name does not exist.

Or, when executing the **Copy** command in the Disk mode Utility page, and you used a wildcard to specify the copy file name, the specified file was not found.

**Meaning:** In Disk mode when you used the Open button to open a directory, the path length including the selected directory name exceeded 76 characters.

Or, when using the **Copy** command in Disk mode, the length of the copy source path exceeded 76 characters.

- Rename the file and/or directories using shorter names, so that the file path fits within 76 characters. The file path includes the file name and the names of all parent directories up to the root level of the disk.

**Meaning:** When executing Insert in the Disk mode Make Audio CD page, you attempted to use the Insert All button to add a WAVE file, but no WAVE file with a sampling frequency of 44.1 kHz or 48 kHz exists in the selected directory.

- Check the file or directory.

**Meaning:** In Disk mode when loading a .KCD file, a WAVE file listed in the Audio Track List could not be found.

- Look at the file sizes on the Make Audio CD page. If a file's size is not shown, it could not be found on the disk. Check the file or directory, or delete it from the Audio Track List.

---

### Front sample data used in rear sample Can't overwrite

**Meaning:** When executing **Link** in the Sampling mode Sample Edit page, the sample data of the front sample is also being used by the rear sample, and therefore cannot be overwritten. To solve this problem:

- Instead of using **Overwrite**, specify a different sample as the save-destination.

---

## H

---

### HD Protected

**Meaning:** The internal SSD is protected. To solve this problem:

- On the Global-Basic tab, under Memory Protect, turn off (un-check) the **Internal HDD Save** check box.

---

## I (Illegal-Index)

---

### Illegal file description

**Meaning:** The filename that you specified when saving a file or creating a directory contained invalid characters. To solve this problem:

- Change the filename you are specifying. Filenames not permitted by MS-DOS cannot be used as a filename.

---

### Illegal SMF data

**Meaning:** You attempted to load a file that was not a Standard MIDI File.

---

### Illegal SMF division

**Meaning:** You attempted to load a Standard MIDI File that was timecode-based.

---

### Illegal SMF format

**Meaning:** You attempted to load a Standard MIDI File of a format other than 0 or 1.

---

### Inconvertible file exists

**Meaning:** A file that cannot be used with ISO9660 format exists on the media. To solve this problem:

- Media that was formatted or written by a device other than the KRONOS may be impossible for the KRONOS to convert into ISO9660 format. To perform the conversion, use the packet writing software that was used to format or write the media.

---

### Index number over limit

**Meaning:** When sampling into RAM in Combination, Program, or Sequencer mode, there are too many indexes to be simultaneously converted into a multisample.

- Either convert the samples into a different program or multisample, or use Sampling mode to delete some of the indexes before you continue sampling.

---

## K

---

### KRONOS system version ... update complete. Please restart the system.

**Meaning:** This message will appear when you've used the Global P0 page menu command **Update System Software**, after the update is complete. Restart the system to use the updated software.

- Turn the power switch off, and then on again.

---

## M (Master–Multisample)

---

### Master Track can't be recorded alone

**Meaning:** When real-time-recording a single track, you attempted to begin recording with the master track as the current track.

- Select a MIDI or Audio Track for recording, instead of the Master Track.

---

### Master Track is empty

**Meaning:** You cannot open Audio Event Edit because the Master Track is empty. To solve this problem:

- Execute the Sequencer P4– Track Edit page menu command **Set Song Length** etc. with an appropriate length to create a master track, and then open Audio Event Edit.

---

### Measure number over limit

**Meaning:** The attempted edit operation would cause the track length to exceed 999 measures.

- Delete unnecessary measures.

---

### Measure size over limit

**Meaning:** When loading a Standard MIDI File, the number of events in a measure exceeded the maximum (approximately 65,535 events).

**Meaning:** The attempted edit operation would cause the maximum number of events in a measure (approximately 65,535) to be exceeded.

To solve either of these problems:

- Use event editing etc. to delete unwanted data.

---

### Medium changed

**Meaning:** When executing the **Copy** command in the Disk mode Utility page, the media was exchanged or ejected, and it was not possible to copy between separate media on the same drive.

---

### Medium unavailable

**Meaning:** You selected a medium that does not allow writing.

---

### Medium write protected

**Meaning:** The other writing-destination media is write-protected.

- Turn off write protect on the other media, and execute the command once again.

---

### Memory full

**Meaning:** In Sequencer mode when editing a song, track or pattern, the total data of all songs has used up all of the sequence data memory, and further editing is not possible. To solve this problem:

- Delete other song data etc. to increase the amount of free memory.

**Meaning:** While real-time recording in Sequencer mode, there is no more free memory to accommodate the recorded data, so recording has been forcibly halted. To solve this problem:

- Delete other song data etc. to increase the amount of free memory.

---

### Memory overflow

**Meaning:** While receiving exclusive data in Disk mode **Save Exclusive**, all remaining internal memory was used up. To solve this problem:

- If you are receiving two or more sets of exclusive data, transmit them separately to the KRONOS.

**Meaning:** In Disk mode, you attempted to load more sample waveform data than there was free memory capacity. To solve this problem:

- In Sampling mode, execute **Delete sample** to create free space in the sample waveform data area, and re-load the data.

---

### Memory Protected

**Meaning:** The internal program, combination, song, drum kit, wave sequence, KARMA GE, or Internal HDD Save is protected.

**Meaning:** The song was protected when you executed.

- In Global mode, turn off write-protect, and execute the write or load operation once again.

---

### MIDI data receiving error

**Meaning:** While receiving MIDI System Exclusive data, the format of the received data was invalid, for example because the size of the data was incorrect.

---

### Mount Error

**Meaning:** This message will appear when you execute the Global mode **Update System Software** command if the CD could not be executed successfully. To solve this problem:

- Try again. Alternatively, try again using a different CD.

---

### Multisample L and R are identical

**Meaning:** Since the destination (save location) L and R multisample numbers are the same, the editing operation could not be executed. To solve this problem:

- Select a different multisample number for the L and R of the destination (save location).

---

## N (No data–Not enough song memory)

---

### No data

**Meaning:** When loading a Standard MIDI File, the file contained no events.

**Meaning:** When you executed Samples in One Multisample in the “Export Samples as AIF/WAV” command in the Disk mode Save page, there were no samples.

To solve either of these problems:

- Create sample data.

---

### No medium

**Meaning:** When executing a command in Disk mode, no media was inserted in the drive. To solve this problem:

- Insert media such as a mount the drive.

---

### No recording track specified

**Meaning:** When performing real-time multi-track recording, you attempted to begin recording with no tracks set to REC. To solve this problem:

- Set the desired tracks for recording to REC.

---

### No Selected Item

**Meaning:** When you attempted to save a single effect with **Save Effect Preset**, there was no effect to be saved.

- If you want to save a single effect, select either the **Preset** or the **User** check box before executing the save.

**Meaning:** When executing **Add KSC** on the Global - Basic KSC Auto-Load tab, you pressed **Add** without selecting a file.

- First select the KSC that you want to add, and then press **Add**.

**Meaning:** When executing **Insert Track** on the Disk - Audio CD - Make Audio CD tab, you pressed **Insert** without selecting a file.

- First select the WAVE file that you want to add, and then press **Insert**.

---

### No space available on medium

**Meaning:** When you attempted to save or copy a file, or to create a directory, there was not enough free space on the other medium. To solve this problem:

- Either delete an existing file, or exchange the medium with one that has sufficient free space.

---

### No space available on medium Do you want to make a divided file?

**Meaning:** When saving a .PCG or .KSF file, there was insufficient free space on the media. Please specify whether you want to save the file in divided form.

- Press the OK button to save the file across multiple volumes of media, or press the Cancel button to cancel.

---

### Not enough Drum Track pattern locations available

**Meaning:** When converting a song's user patterns to user drum track patterns, the allowable number of user drum track patterns was exceeded. To solve this problem:

- As necessary, use the Disk mode **Save PCG** command to save the user drum track patterns. Then in Sequencer mode, use the **Erase Drum Track Pattern** menu command to free up more drum track user patterns. After that, try the conversion again.

---

### Not enough Drum Track pattern memory

**Meaning:** When converting a song's user patterns to user drum track patterns, there was not enough free memory. To solve this problem:

- As necessary, use the Media mode **Save PCG** command to save the user drum track patterns. Then in Sequencer mode, use the **Erase Drum Track Pattern** menu command to delete the other user drum track patterns to free up more memory. After that, try the conversion again.

---

### Not enough empty slot to copy

**Meaning:** This message will appear when you execute Copy Insert Effect or Copy From Program if there are not enough vacant insert effects in the copy-destination. To solve this problem:

- Set unused insert effects in the copy-destination to 000: No Effect so that there will be enough vacant insert effects.

---

### Not enough memory

**Meaning:** When starting real-time recording in Sequencer mode, the minimum amount of free memory (such as memory for the BAR events up to the recording start location) could not be allocated. To solve this problem:

- Delete other song data etc. to increase the amount of free memory.

**Meaning:** When executing “Load Exclusive,” you attempted to load an .EXL file that required more than 1,048,576 bytes. Such a file cannot be loaded by the KRONOS.

**Meaning:** When in Disk mode you attempted to load an EXL file from media other than the internal disk, memory for temporary use could not be allocated on the internal disk.

To solve either of these problems:

- On the internal disk, create free space that is larger than the .EXL file.

---

### Not enough memory to load

**Meaning:** When you attempted to load a .SNG file or a standard MIDI file in Disk mode, there was insufficient free memory in the sequence memory. To solve this problem:

- Delete other song data etc. to increase the amount of free memory.

---

### Not enough memory to open pattern

**Meaning:** There was insufficient sequencer memory to open the pattern, so editing is not possible.

- Either delete unwanted data such as a song, track, or pattern, or do not open the pattern.

---

### Not enough multisample memory

**Meaning:** There is insufficient multisample memory. (The number of multisamples would exceed the maximum of 4,000.) To solve this problem:

- Delete multisamples to increase the amount of free memory.

---

### Not enough pattern locations available

**Meaning:** When using the **Load Drum Track Pattern** command, you attempted to load more than the remaining number of user patterns in the selected song. To solve this problem:

- Create a new song, and reload the patterns into user patterns of the new song. You can load up to 100 user patterns for each song. If you need to load more than this number of drum tracks or patterns, you can distribute them between two or more songs.

**Meaning:** When using **Auto Song Setup**, the new song could not be automatically created because there was no song with the initial settings. If you executed the Global mode **Change all bank references** command on the song, all songs will differ from the initial settings, causing the system to determine that there is no song with the initial settings.

---

### Not enough region locations available

**Meaning:** The allowable number of regions was exceeded during realtime-recording, or when you attempted to load an entire SNG file, 1 Song, or Tracks with regions being appended.

- In Sequencer P4– Track Edit, select the audio track and use the page menu command **Region Edit** to create enough vacant space following the last region so that the allowable number of regions will not be exceeded. Then try the operation again.

---

### Not enough relative parameter memory

**Meaning:** There is insufficient memory for relative parameters. (The number of samples in the multisamples would exceed the maximum of 16,000.)

- Delete multisamples or indices of multisamples to increase the amount of free memory.

---

### Not enough sample memory

**Meaning:** There is insufficient sample memory (for sample parameters or sample waveform data).

- Delete samples to increase the amount of free memory.

---

### Not enough sample/multisample locations available

**Meaning:** The data you attempted to load would exceed the maximum number of multisamples or samples. To solve this problem:

- In Sampling mode, use **Delete Multisample** or **Delete Sample** to free a sufficient number, and reload the data.

---

### Not enough song locations available

**Meaning:** When loading a .SNG file with **Append** specified, you attempted to load more songs than can be loaded.

**Meaning:** When executing Auto Song Setup, a new song could not be selected automatically because there was no song with the default settings. This can be caused by using the Global mode “Change all bank references” command with the Song option selected, since this modifies the settings of all songs away from the defaults; after this, the system will not recognize those songs as being empty and available.

- In Sequencer mode, use the **Initialize Song** command to increase the number of Songs that can be used, and then load the song again.

---

### Not enough song memory

**Meaning:** When executing the Sampling mode **Time Slice** or **Save** commands, the total data for all songs occupies all of the sequence data memory area, so that saving is not possible.

**Meaning:** When sampling to RAM in Sequencer mode, it is not possible to create track data at the same time.

- Increase the amount of free memory, for example by deleting another song.

---

### No unused WAVE files found

**Meaning:** When you executed the Disk Utility page menu command **Delete Unused WAVE files**, no unused WAVE files were found.

---

## O (Obey copyright rules–Oscillator)

---

### Obey Copyright Rules

**Meaning:** When you execute the Disk mode Make Audio CD page **Write to CD** command, or when you execute **Destination** in the Sampling mode Audio CD page **Destination** command.

Please read “**COPYRIGHT WARNING**” on page 3 of the Quick Start Guide before you use this data.

---

### Oscillator Mode conflicts (Check PROG P1)

**Meaning:** In Sampling mode when you executed **Convert MS To Program** with Use Destination Program Parameters checked, the conversion destination program **Oscillator Mode** setting did not match.

- In Program mode, set the **Oscillator Mode** of the conversion destination program. If converting a monaural multisample, select Single. If converting a stereo multisample, select Double.
- 

## P (Pattern–Program)

---

### Pattern conflicts with events

**Meaning:** It was not possible to execute the Bounce operation because one of the tracks contained a pattern, and the same measure of the other track contained events or a pattern.

- Open the pattern.
- 

### Pattern exists across destination to-end-of-measure or source from-measure

**Meaning:** When moving a measure, the edit operation could not be executed because a pattern had been put in the destination end measure or the source start measure, and had not been opened.

- Open the pattern.
- 

### Pattern exists in destination or source track - Open pattern?

**Meaning:** A pattern has been placed in the track that you specified as a destination or source for editing. If you wish to open the pattern and execute (the events of the pattern will be copied), press the OK button. If you wish to execute without opening the pattern, press the Cancel button.

---

### Pattern used in song - Continue?

**Meaning:** When editing, the specified pattern has been placed in a track. If you wish to execute, press the OK button. If you decide not to execute, press the Cancel button.

---

### Program Bank Type conflicts

**Meaning:** When receiving a dump of an individual bank or a single program, the KRONOS received a program that did not match the bank type. If the bank type does not match, the program will not be received.

**Meaning:** When receiving an All Programs dump, the KRONOS received a bank whose bank type did not match. Only banks of the matching bank type will be received.

- Use the **Set Program Bank Type** command (on the Global P0 Basic Setup page) to change the bank type so that it's the same as the one being transmitted, and then try the operation again.
- 

### Program Type conflicts

**Meaning:** This message will appear when you execute Copy Tone Adjust if the copy-source and copy-destination program types are different. You cannot copy between HD-1 and EXi Programs, or between different types of EXi Programs.

---

## R (Rear sample–Root)

---

### Rear sample is empty

**Meaning:** When you executed **Link** in the Sampling mode Sample Edit page, the sample that you specified as the rear sample is empty.

- Specify a sample that contains data as the rear sample, and execute once again.
- 

### Root directory is full

**Meaning:** You attempted to create a file or directory in the root directory of the media, but this would exceed the maximum number of root directory entries.

---

- Either delete an existing file or directory, or Open a directory to move down one level before executing once again.

---

## S (Sample–Source)

---

### Sample data used in other sample(s) Continue?

**Meaning:** Other sample(s) use the same sample data as the sample that you are editing. To continue editing, press the OK button.

---

### Sample L and R are identical

**Meaning:** The edit operation could not be executed because the destination (save location) L and R sample numbers are identical.

- Select different sample numbers for L and R of the destination (save location).

---

### Sample length is shorter than minimum

**Meaning:** You attempted to execute an editing operation that would make the sample data shorter than 8 samples.

- Change the editing range so that the sample data will be longer than 8 samples.

---

### Sample used in other multisample(s) Continue?

**Meaning:** The sample you are editing is used by other multisamples. To continue editing, press the OK button.

---

### Selected file/path is not correct

**Meaning:** When loading a divided .PCG file, you attempted to load a .PCG file of the same name that was not divided or had differing contents.

- Load the correct .PCG file.

**Meaning:** When loading a KSF file that was split across multiple media, the order in which you attempted to load the files was incorrect.

- Load the KSF file in the correct order. To view the file number order in which the KSF files were saved, you can check the **Translation** page menu command. (The

---

## T (The clock–/TEMP folder detected)

---

### The clock battery voltage is low. Please replace the battery, and set the date and time in Disk mode.

**Meaning:** The battery for the clock/calendar function has run low, and needs to be replaced. Your Korg Distributor can help you find a service center to replace the battery.

sample name and number of the first KSF file will be displayed.)

---

### Slice point over limit Can't divide

**Meaning:** When using the Sampling mode **Time Slice** or **Time Stretch** commands, the Slice setting would divide the sample into more samples than the maximum possible number (1000), and thus **Divide** cannot be executed.

- Use **Link** to connect any **Index** that you do not require, and then execute **Divide**.

---

### Source file is not 44100Hz or 48000Hz Can't convert

**Meaning:** When executing the Disk mode Utility page menu command **Rate Convert**, you selected a WAVE file of a sampling rate other than 44.1 kHz or 48 kHz.

- You cannot convert WAVE files other than 44.1 kHz or 48 kHz.

---

### Source IFX is all empty

**Meaning:** This message will appear when you execute Copy Insert Effect or Copy From Program if there is no insert effect to be copied.

---

### Source is empty

**Meaning:** No data exists in the track or pattern that you specified as the source.

- Specify a track or pattern that contains musical data.

---

### Source sample is empty

**Meaning:** When executing Insert, Mix, or Paste, the source sample is empty.

- Execute the Copy operation before executing Insert, Mix, or Paste.

---

### The data on the medium will be lost. Are You Sure?

**Meaning:** When you format a disk, all of the data on the disk will be erased. Make sure that you have any data backed up before proceeding! To proceed with formatting the disk, press **OK**.

---

### There is no readable data

**Meaning:** Either the file size is 0 or the file does not contain data that can be accessed by the load or open operation. Alternatively, the data is damaged etc., and cannot be loaded or accessed.

---

### This file is already loaded

**Meaning:** When loading a divided .PCG file, you attempted to load a file that had already been loaded.

- Load the .PCG files that have not yet been loaded.

---

### Track is full

**Meaning:** In the Disk mode Make Audio CD page, you attempted to insert a track that would make the total exceed 99 tracks.

- Cut unneeded tracks, and then execute the Insert operation once again.

---

### /TEMP folder detected.

**This folder may contain unsaved WAVE files from a previous audio track recording session.**

**Do you want to restore the /TEMP folder, or delete it from the disk?  
[Restore] [Delete]**

**Meaning:** The WAVE files created when you recorded audio tracks before powering-off were not saved as song data, and remain in the TEMP folder of the internal disk. Since the data was not saved as song data, all audio events and region data were deleted, but if necessary you can save these WAVE files and use them to create a new song.

- If you want to keep this data, press Restore. If you want to delete this data, press Delete.

---

## U (Unable to create directory–USB Hub)

---

### Unable to create directory

**Meaning:** You attempted to create a directory that would exceed the maximum path length of 76 characters. The path includes the names of the directory and all its parent directories up to the root level of the disk.

- Rename the directories using shorter names, so that the file path fits within 76 characters.

path includes the file name and the names of all parent directories up to the root level of the disk.

**Meaning:** When using the Copy command in Disk mode, not enough temporary storage space was available.

---

### Unable to save file

**Meaning:** When saving a file in Disk mode, using the Copy command in Disk mode, or sampling to disk as a WAVE file, the resulting file path exceeded 76 characters.

To solve this problem:

- Rename the file and/or directories using shorter names, so that the file path fits within 76 characters. The file

---

### USB HUB Power exceeded Please disconnect USB device

**Meaning:** The power consumption of your USB devices has exceeded the capacity of the hub to which they are connected. The USB hub will not be recognized correctly in this state. To solve this problem:

- If you're using a USB hub or device that is capable of being self-powered, use it in self-powered mode.
- If you are using more than one USB hub, try connecting the device to a different USB hub.

---

## W (Wave)

---

### .WAV already exists. Overwrite?

**Meaning:** When importing a WAVE file that requires conversion to 48kHz/mono, a file of the same name already exists on the disk. To solve this problem:

- Either delete the existing file, or rename it before importing.

---

### WAVE files on this external medium will not be played with sequencer audio track playback. Copy SNG and WAVE Directory to Internal HDD, and load SNG from internal HDD

**Meaning:** The WAVE file used by the SNG data you're loading in Disk mode exists on external media, and will not play back correctly when loaded. Audio track recording and playback is available only on the internal disk. To solve this problem:

- Copy the .SNG file and the directory for that .SNG file (the directory containing the WAVE files it uses) to the same directory of the internal disk, and then load the data again.



---

**WAVE file size over limit**

**Meaning:** When editing an audio track in Sequencer mode, you exceeded the maximum number of 230,400,000 samples (80 minutes at a sample rate of 48 kHz, 16-bit) allowable in a WAVE file.

---

**Y (You)**

---

**You can't undo this operation****Are you sure?**

**Meaning:** Once you enter event editing (even if you leave event editing without actually editing an event), it will no longer be possible to execute a Compare of the previous edit. If you wish to enter event editing, press the OK button. To cancel, press the Cancel button.

---

**You can't undo last operation****Are you sure?**

**Meaning:** When you exit recording or event editing in Sequencer mode, the memory area for Undo (Compare function) is not allocated. If you wish to keep the data that was just recorded or edited, press the OK button. If you wish to return to the previous data (i.e., to delete the data that was just recorded or edited), press the Cancel button.

**Meaning:** When editing in Sequencer mode, memory area for Undo (Compare function) cannot be allocated. If you wish to execute the edit, press the OK button. (It will not be possible to return to the state before editing.) If you decide not to execute the edit, press the Cancel button.

- In order to allocate memory area for Undo (Compare function), delete unneeded data such as songs, tracks, or patterns. We recommend that you save data to media before you execute the edit operation.

## Disk and Media information

### Types of media supported by the KRONOS

#### Internal disk

Naturally, you can read and write data using the built-in disk.

#### External USB storage media

The KRONOS supports USB external storage class devices, including hard drives, flash drives, magneto-optical disks, floppy disks, etc. Both MS-DOS FAT16 and FAT32 formats are supported, with the following capacities:

- FAT32: up to 2 Terabytes (2,000 Gigabytes)
- FAT16: up to 4 Gigabytes

For more information, including requirements for external USB storage media and details on connecting USB devices, please see “5. Connecting USB devices” on page 23.

#### USB CD-R/RW and DVD

Using a USB CD-R/RW drive, the KRONOS can read and write UDF format CD-R/RW disks. For more information, see “CD-R/RW disks on the KRONOS: UDF and packet-writing” on page 1156 of the Parameter Guide.

The KRONOS can also play and record audio CDs (CD-DA), read ISO9660 (level 1) CDs, and read UDF format DVD disks.

### Operations that the KRONOS can perform on media

#### Functions available with all media

- Saving and Loading files (Disk mode)  
You can save and load any data stored in memory. For details on KRONOS file types, please see “Files, directories, and icons” on page 815 of the Parameter Guide. Loading or saving divided files is supported for USB media.
- Utility operations (Disk mode)  
You can copy or format media.
- Sampling/resampling (Program, Combination, Sequencer, Sampling modes)  
If **Save to** = Disk, sampled/resampled Wave files will be written directly to media.
- Wave file playback (Sequencer, Disk modes)  
Some limitations apply.\*2
- Audio CD creation (Disk mode)  
You can create audio CDs from WAVE files, using either internal or USB CD-R/RW drives.
- Convert to ISO9660 Format (Disk mode)  
The native KRONOS CD-R/RW format is UDF, which allows you to write repeatedly to the same CD. UDF is a standard format, but you can also convert such disks to the more common (but less flexible) ISO9660 format.

#### Functions available only on the internal disk(s)

- Audio recording and playback (Sequencer mode)  
You can record and play back audio tracks.
- Audio track editing (Sequencer mode)  
You can edit the WAVE files used by audio tracks.

Function	Internal Disk	USB HD, Flash Drives, MO	USB Floppy Disks	USB CD-R/RW (UDF Packet Write)	USB CD-R/RW (ISO9660)	USB DVD-ROM (ISO9660, UDF)
Save	●	●	●	●	x	x
Load	●	●	●	●	●	●
Sampling/Resampling	●	●	x	_*1	_*1	x
WAVE File Play	●	●	x	x	x	●
Make Audio CD	● (source)	● (source)	x	●	● (source)	x
Convert to ISO9660 Format	–	–	–	●	–	x
Audio Track Recording	●	x	x	x	x	x
Audio Track Edit	●	x	x	x	x	x

● : supported

x : not supported

– : not applicable

\*1: CD-DA (audio CDs) can be ripped in Sampling mode.

*Note:* If you have any questions regarding the media that can be used, please contact your local Korg distributor. You may also check the Korg website (<http://www.korg.com>).

## Restoring the factory settings

### Restoring the original sounds

You can easily restore the Programs, Combinations, Drum Kits, Wave Sequences, Set Lists, and EXs samples to their original state as shipped from the factory. This is done by loading the PRELOAD.PCG file, which is included both on Accessory Disc 3 and the internal disk.

- ⚠ This operation will erase all of the internal KRONOS sounds. If there are any non-factory sounds that you want to keep, save them to disk now! For more information, see “Saving data” on page 191.

### Make sure that Memory Protect is off

Before loading, make sure that **Memory Protect** is turned off:

1. Press the front-panel **GLOBAL** button.
2. Go to the **Basic** tab of the **Basic Setup** page.
3. Make sure that all of the **Memory Protect** check-boxes are *not* checked.

### Loading from the internal disk

Generally, it will be more convenient to load sounds from the internal disk:

1. Press the **DISK** button to enter **Disk mode**.
2. Go to the **Load** tab of the **File** page.

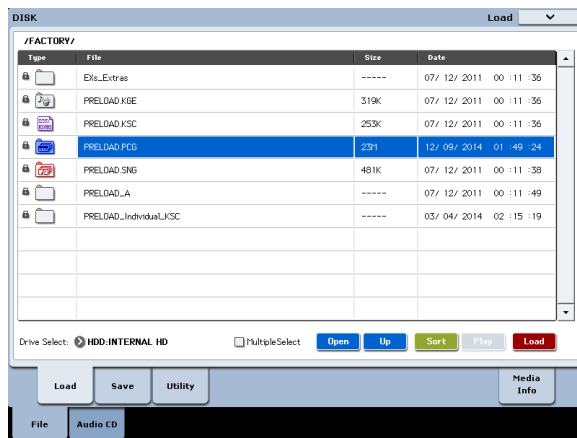

3. Use **Drive Select** to select **HDD**.

The LCD screen will show the files and folders on the internal disk.

4. Touch the **FACTORY** folder to select it.
5. Press the on-screen **Open** button.

The LCD will now show the contents of the **FACTORY** folder.

6. Select the **PRELOAD.PCG** file.
7. Press the **Load** button.

The Load PCG dialog box will appear.

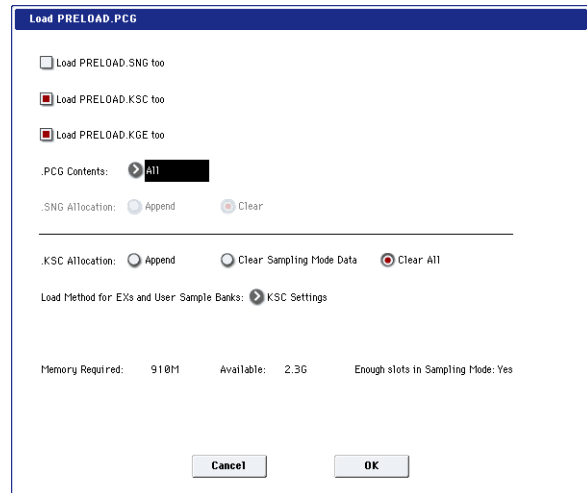

8. Use **“.PCG Contents”** to select the data you want to load. To completely restore the factory sounds, select **All**.

“All” will load all of the factory sounds, including Programs, Combinations, Set Lists, Drum Kits, Wave Sequences, and Drum Track patterns.

For more information on the factory sounds, see “Program bank contents” on page 31, “Combination bank contents” on page 63, “Drum Kit memory structure” on page 186, and “Wave Sequence banks” on page 178.

9. Set **“.KSC Allocation”** to **Clear All**.
10. Set the **Load Method for EXs and User Sample Banks** to **KSC Settings**.

11. Press the **OK** button to load the data.

Next, to make sure that the KSC loads automatically at startup:

12. Go to the **Global Basic—KSC Auto-Load** page.
13. In the list of KSCs, check the **Auto-load** box next to **PRELOAD.KSC**.
14. Un-check all of the other KSCs.

### Loading from Accessory Disc 3

If the sounds have somehow been erased from the internal drive, you can also load them from Accessory Disc 3:

1. Insert the included **Accessory Disc 3** into a connected **USB DVD** drive.
2. Press the **DISK** button to enter **Disk mode**.
3. Wait for a few seconds, to give the **KRONOS** time to recognize the disk.
4. Go to the **Load** tab of the **File** page.
5. Use **Drive Select** to select **CDD**.

The LCD screen will show the files and folders on the disk.

6. Follow the instructions in steps 4 through 14 under “Loading from the internal disk,” above.

- ⚠ Never attempt to remove media while data is being loaded.

## Specifications

<b>Operating temperature</b>	+5 – +40 °C (no condensation)			
<b>System/Keyboard</b>	System	KRONOS System Version 3.0		
	Keyboard	61-key	Natural Touch Semi Weighted	
		73-key	RH3 (Real Weighted Hammer Action 3) <sup>*1</sup>	
		88-key	RH3 (Real Weighted Hammer Action 3) <sup>*1</sup>	
*1: The key weight of the RH3 keyboard differs in four stages across the pitch range (with low notes being heavier, and high notes being lighter), delivering a playing feel similar to that of a grand piano.				
<b>Tone Generator</b>	Synthesis Types: 9	HD-1	High Definition Synthesizer (PCM)	HD-1
		AL-1	Analog Synthesizer (Analog Modeling)	EXi (Expansion Instruments)
		CX-3	Tonewheel Organ (Tonewheel Organ Modeling)	
		STR-1	Plucked String (Physical Modeling)	
		MS-20EX	Component Modeling Technology (Analog Modeling)	
		PolysixEX	Component Modeling Technology (Analog Modeling)	
		MOD-7	Waveshaping VPM Synthesizer (VPM Synthesis)	
		SGX-2	Premium Piano (Acoustic Piano)	
		EP-1	MDS Electric Piano (Electric Piano)	
	Maximum Polyphony <sup>*2*3</sup>	HD-1	140 voices	
		AL-1	80 voices	
		CX-3	200 voices	
		STR-1	40 voices	
		MS-20EX	40 voices	
		PolysixEX	180 voices	
		MOD-7	52 voices	
		SGX-2	100 voices <sup>*4</sup>	
		EP-1	104 voices	
		*2: In rare cases, when a large number of processor-intensive effects are active simultaneously (for instance, more than 14 O-Verbs), polyphony may be slightly reduced.		
	*3: A portion of the multicore processor in KRONOS is devoted to generating voices, and a separate portion is devoted to generating effects. KRONOS dynamically allocates the voice processing power between the engines as necessary. The quoted maximum numbers of voices apply when 100% of the voice processing power is devoted to a single engine.			
	*4: 100 dual-stereo notes (equivalent to 400 mono voices)			
	Preset PCM	314 MB (ROM 1,505 multisamples, 1,388 Drumsamples)		
	Build-in Expansion PCM Libraries	EXs1	ROM Expansion	
EXs2		Concert Grand Piano		
EXs3		Brass & Woodwinds		
EXs4		Vintage Keyboards		
EXs5		ROM Expansion 2		
EXs6		SGX-1 German D Piano		
EXs7		SGX-1 Japanese C Piano		
EXs8		Rock Ambience Drums		
EXs9		Jazz Ambience Drums		
EXs17		SGX-2 Berlin D Piano		
EXs18	Korg EXs Collections			
PCM RAM capacity	About 2GB <sup>*5</sup>			
	*5: The memory available for Sampling Mode will change based on the use of Expansion PCM libraries and User Sample Banks.			
Wave Sequences	Preload	187 Wave Sequences		
	User Memory	598 Wave Sequences		
	Support for stereo multisamples, synchronization of individual notes, and tempo-based settings.			

<b>HD-1 Program</b>	Advanced Vector Synthesis	Control oscillator volumes and synthesis & effects parameters via the Vector Joystick and the tempo-synchronized Vector Envelope.	
	Structure	Single: only OSC1, Double: OSC1 and OSC2. Double mode lets you layer two completely separate synth voices, each with their own velocity-switched oscillator, dual filter, EGs, LFOs, etc.	
		Drums: One drum kit, Double Drums: Two drum kits.	
	Oscillator	Virtual Memory Technology (VMT) plays large samples directly from the internal SSD. 8 velocity zones per oscillator, with switching, crossfades and layering. Each zone can play mono or stereo Multisamples or Wave Sequences.	
	Filters	Two multi-mode filters per voices (low-pass, high-pass, band-pass and band-reject), Four-mode filter routings (single, serial, parallel and 24dB mode).	
	Driver	Per voice non-linear driver and low boost circuit.	
	EQ	Three bands, with sweepable mid.	
Modulation	Three envelope generators, two LFOs per voice, common LFO, four key tracking generators, AMS (Alternate Modulation Source), two AMS mixers.		
<b>EXi Program Common</b>	Advanced Vector Synthesis	Control oscillator volumes and synthesis & effects parameters via the Vector Joystick and the tempo-synchronized Vector Envelope.	
	Modulation	Common Step Sequencer, AMS (Alternate Modulation Source), Common LFO, 2 Key Tracking Generators.	
	EQ	Three bands, with sweep-able mid	
<b>AL-1 Program</b>	Oscillators	Ultra-low-aliasing oscillators	
		OSC1, OSC2, Sub-oscillator and noise generator; ring modulation, FM and Sync.	
	Audio Input	External audio can be processed through the ring modulator, filter, driver, amp, and EQ.	
	Filters	Two multi-mode filter (low-pass, high-pass, band-pass and band-reject) with four types of filter routings (single, serial, parallel and 24dB mode), MultiFilter mode (only Filter-A; modulatable mix of Low Pass, High Pass, Band Pass, and dry input, for creating a wide variety of unique filter types and effects).	
	Driver	Per-voice non-linear driver and low boost circuit.	
	Modulation	Five Envelope generators, four per-voice LFOs, two Key Track generators, two AMS Mixers, Per-voice Step Sequencer.	
<b>CX-3 Program</b>	Tonewheel Organ Modeling	Phase-synchronous tonewheels (clean and vintage modes), percussion, key click, wheel brake.	
	EX Mode	Four additional, user-specified drawbars, and expanded percussion.	
	Internal Effects	Rotary speaker, vibrato/chorus, amp modeling with overdrive, 3-band EQ.	
	Drawbar Control	Controlled via nine front-panel sliders (via Tone Adjust).	
	Split	Upper, Lower	
	Modulation	Two AMS mixers.	
<b>STR-1 Program</b>	Physically Modeled String	Includes physically modeled damping, decay, dispersion, nonlinearity, harmonics, dual pickups, and more.	
		Most string parameters can be controlled in realtime.	
	String Excitation	Three independent excitation sources can be used simultaneously: Pluck, Noise, and PCM.	
		16 preset "pluck" types, with modulatable width and randomization.	
		Noise generator with saturation and dedicated lowpass filter.	
		PCM Oscillator	Korg's ultra-low-aliasing technology, as introduced in the HD-1.
			4 velocity zones per oscillator.
			Uses any mono Multisamples, including ROM, EXs, User Sample Bank, or Sampling Mode. Supports Virtual Memory.
	Excitation Filter	PCM can either be used as an excitation signal, or layered with the output of the string.	
		Dedicated 2-pole multimode filter for shaping the string excitation.	
		Filter can be enabled/disabled separately for each excitation source. Low Pass, High Pass, Band Pass, and Band Reject modes.	
Audio Input and Feedback	Run real-time audio through the string, including feedback through effects.		
	Modeled feedback includes modulate-able instrument-to-amp distance and orientation.		
Filters	Dual multi-mode filters per voice; Single, Serial, Parallel (with split stereo output), and 24dB (4-pole) configurations. Low Pass, High Pass, and Band Reject modes.		
	Multi Filter mode (Filter A only).		
	Modulatable mix of Low Pass, High Pass, Band Pass, and dry input, for creating a wide variety of unique filter types and effects.		
Modulation	5 Envelopes, 4 per-voice LFOs, 2 Key Track generators, String Tracking generators, 4 AMS Mixers.		

<b>MS-20EX Program</b>	Oscillators	Ultra-low-aliasing oscillators. VCO1, VCO2, Ring Mod, Pink and White Noise Generator.	
	Audio Input	Run real-time audio through the synthesis engine and ESP (External Signal Processor).	
	Filters	12dB/octave High Pass and Low Pass self-resonant filters. ESP section: 24dB/octave Low Cut and High Cut filters, available per voice.	
	Patch Panel	Patchable audio and modulation, at audio rates.	
	Patch Points	Keyboard: Keyboard CV Out, Keyboard Trigger Out, VCO1+VCO2 CV In, VCO2 CV In VCO: VCO1+VCO2 External Frequency Control In, VCO1 Out*, VCO2 Out* VCF: External Signal In, External HP Filter Cutoff Frequency Control In, External LP Filter Cutoff Frequency Control In, HPF Out*, LPF In*, LPF Out* VCO+VCF: Total External Modulation In VCA: External Initial Gain Control In, VCA In* EG: EG1 Envelope Signal Normal Out, EG1 Envelope Signal Reverse Out, EG1+EG2 Trigger In, EG1 Trigger In, EG2 Envelope Signal Reverse Out MG: Triangle Out, Rectangle Out Noise Generator: Pink Noise Out, White Noise Out Sample and Hold: Clock Trigger In, Sample Signal In, S/H Out Modulation VCA: Control Voltage In, Signal In, Signal Out Manual Controller: Control Wheel Out, Momentary Switch ESP: Signal In, AMP Out, BPF In, BPF Out, F-V CV Out, Envelope Out, Trigger Out Others: EXi Audio In*, Mixer 1 In*, Mixer 1 Out*, Mixer 2 In*, Mixer 2 Out*	
	* New patch points not provided on the original MS-20.		
	ESP (External Signal Processor)	Use incoming audio as a trigger and/or CV source.	
Modulation	MS-20: Original DAR and HADSR EGs 1 & 2, original MG (with MIDI sync), Sample-and-Hold, MVCA. KRONOS: 4 additional multi-stage Envelopes, 4 additional per-voice LFOs, and 4 AMS Mixers.		
<b>PolysixEX Program</b>	Oscillators	VCO: Saw, Pulse, PWM Sub Oscillator: Off, 1 octave below, 2 octaves below	
	Filter	24dB (4-Pole) Low Pass self-resonant filter	
	Effects	Integrated Polysix Chorus, Phase, and Ensemble.	
	Arpeggiator	Integrated MIDI-synced arpeggiator, with adjustable Range, Mode, and Latch.	
	Modulation	Polysix: Original ADSR EG and MG (with MIDI sync). KRONOS: 2 additional multi-stage Envelopes, 2 additional per-voice LFOs, and 4 AMS Mixers.	
	<b>MOD-7 Program</b>	Waveshaping VPM Synthesizer	Combines Variable Phase Modulation (VPM), waveshaping ring modulation, PCM sample playback, and subtractive synthesis. Able to convert-load SYX files.
Oscillators		6 VPM/Waveshaper/Ring Modulation Oscillators	Phase and modulatable pitch per oscillator.
			101 Waveshaper tables plus modulatable Drive and Offset.
			Use as oscillators, or as Waveshapers or Ring Modulators for other signals.
		PCM Oscillator	Korg's ultra-low-aliasing technology, as introduced in the HD-1.
			4 velocity zones per oscillator.
			Uses any mono Multisamples, including ROM, EXs, User Sample Bank, or Sampling Mode. Supports Virtual Memory. PCM can be used as an FM modulator and/or layered with the VPM Oscillators.
		Noise generator with saturation and dedicated low pass filter.	
Audio input		Run real-time audio through the VPM Oscillators and filters.	
Filters		Dual multi-mode filters per voice (Low Pass, High Pass, Band Pass, and Band Reject modes). Two types of filter routing (parallel, 24 dB (4-pole)). Multi Filter mode (Filter A only): Modulatable mix of Low Pass, High Pass, Band Pass, and dry input, for creating a wide variety of unique filter types and effects.	
	Patch Panel	Supports both algorithm (78 types) selection and free patching. Three 2-in, 1- out mixers for scaling and merging audio, fully modulatable, with phase inversion. Main 6-input stereo mixer, with modulatable pan and volume, plus phase inversion.	
Modulation	10 Envelopes, 4 per-voice LFOs, 9 Key Tracking generators, Per-voice Step Sequencer, 4 standard AMS Mixers plus 4 simple AMS Mixers.		
<b>SGX-2 Program</b>	Premium Piano	Virtual Memory Technology (VMT) plays large samples directly from the internal SSD. Chromatically sampled at up to 12 velocity levels, no looping. Damper resonance and mechanical noise. Modeled String Resonance. Una Corda sample support.	
	PCM	EXs6 - SGX-1 German D Piano, EXs7 - SGX-1 Japanese C Piano, and optional EXs12: SGX-1 Austrian D Piano (8 velocity levels, no Una Corda samples); EXs17 - Berlin D Piano (12 velocity levels, includes Una Corda samples)	
	Piano Type	64 or more	
	Oscillator Control	Damper Resonance, Damper Noise, Mechanical Noise, Note Release, String Resonance	

<b>EP-1 Program</b>	MDS Electric Piano	Tine-type and reed-type electric pianos powered by Multi-Dimensional Synthesis (MDS), and vintage effects.		
	Electric Piano Model Types: 6	Tine EP I, Tine EP II, Tone EP V, Tine EP DMP, Reed EP200, Reed EP200A		
	Oscillator Control	Harmonic Sound Level, Attack Noise Level, Release Noise Level, Attack Brightness, Hammer Width		
	Panel Control	Tine Type	Preamp Volume, Tone (Treble, Bass), Vibrate (On/Off, Intensity, Speed), Amp/Cabinet (On/Off, Drive)	
		Reed Type	Preamp Volume, Tone (Treble, Bass), Vibrate (Intensity, Speed), Amp/Cabinet (On/Off, Drive)	
Effect Types: 9	Small Phase, Orange Phase, Clack Phase, Vintage Chorus, Black Chorus, EP Chorus, Vintage Flanger, Red Comp, VOX Wah			
<b>Combination</b>	Number of Timbres	16 Maximum		
	Master Keyboard Functionality	Keyboard and velocity splits, layers, and crossfades of up to 16 Programs and/or external MIDI devices.		
	Advanced Vector Synthesis	Control oscillator volumes and synthesis & effects parameters via the Vector Joystick and the tempo-synchronized Vector Envelope.		
<b>Drum kit</b>	Assignable stereo/mono samples with 8 velocity zones per oscillator (with crossfade functions).			
<b>Number of Programs/Combinations/Drum kits</b>	User memory programs	2,560 (1,792 or more preloaded [896 or more HD-1+896 or more EXI])		
	User memory combinations	1,792 (480 or more preloaded)		
	User memory drum kits	264 (78 or more preloaded)		
	256 GM Level2 preset programs+ 9 GM Level 2 drum preset programs			
<b>Set lists</b>	Number of set lists/slots	128 set lists, 128 slots per set list		
	Each set list provides a 9-band graphic EQ, and a Tone Adjust function that allows program settings to be adjusted.			
	Hold Time setting of Smooth Sound Transition (SST) supported for each slot.			
<b>Sampling</b>	System	Open Sampling System (resampling, In-Track sampling)		
	Bit/Frequency	RAM: 16bit/48kHz Stereo/Mono Sampling Disk: 16 or 24 bit/48kHz		
	Sampling time	RAM: Depends on the amount of available PCM RAM DISK: Maximum of 80 minutes stereo (879 MB: 16bit)		
	Samples	16,000 samples/4,000 multisamples (128 indexes per multisample)		
	Ripping	Direct sampling (ripping) from audio CD (CD-DA)		
	Formats	Korg format, AKAI S1000/S3000 data (with advanced Program parameter conversion); SoundFont 2.0, AIFF, and WAVE formats		
	Editing	Time Stretch, Time Slice, Crossfade Loop, and other standard editing features.		
<b>Effects</b>	Insert Effects	12, Stereo in / stereo out		
	Master Effects	2, Stereo in / stereo out		
	Total Effects	2, Stereo in / stereo out		
	Timbre/Track EQ	One 3-band EQ for each timbre/track		
	Effect Types	197 different Effects types (Any Effect type may be used for Insert, Master, or Total Effects.)		
	Modulation	Dynamic Modulation and Common LFO		
	Effects Control Busses	Stereo side-chaining for compressors, gates, vocoders, etc.		
	Effect Presets	783, Maximum 32 per 1 effect (Preset User)		
<b>KARMA</b>	KARMA Modules	One module in Program mode, four modules in Combination and Sequencer modes.		
	Generated Effects (GE)	2,048 presets, 1,536 Users (96 come Preload)		
	Controllers	On/Off, Latch, Chord, Assign, Module, Control		
		KARMA Realtime Control Sliders [1]–[8], KARMA Scene [1]–[8], KARMA Switches [1]–[8], KARMA Wave-Sequencing, GE Sub Category, Freeze Randomize, Time Signature Control, Tempo Synchronize		
Auto RTC (Real Time Control) setup				
<b>Drum Track</b>	Preset patterns	718 preset (common with the preset patterns of the MIDI sequencer)		
	User patterns	1,000 patterns Patterns created in Sequencer mode can be converted to drum track user patterns.		
	Trigger Mode/Sync/Zone settings can be specified.			
<b>Sequencer/HDR</b>	Tracks	16-track MIDI sequencer + 16-track hard disk recorder + master track.		
	Number of Songs	200 songs		
	Resolution	↓/480		
	Tempo	40.00–300.00 (1/100 BPM resolution)		
	Maximum memory	400,000 MIDI events (with MIDI data only) or 300,000 Audio events (with Audio data only)		
	MIDI Tracks	16 tracks plus the master track 718 preset/100 user patterns (per song) 18 preset/16 user template songs Format: Korg (KRONOS, OASYS) format, SMF formats 0 and 1		
	Audio Tracks	16-track playback, 4-track simultaneous recording, WAV file format 16bit/24bit Automation: Volume, Pan, EQ, and Send 1/2 10,000 regions (max.), Event Anchors, BPM Adjust		
	Other Functions	RPPR (Realtime Pattern Play and Record): 1 Pattern set per song. Auto Song Setup function		



<b>General</b>	Disk Mode	Load, save, utility, audio CD burning, audio CD playback, data filer function (save/load MIDI System Exclusive data), CD-R/RW (UDF format read/write), ISO9660 Level 1			
	Controllers	Vector joystick, joystick, ribbon controller, switches 1 & 2			
		Control Surface	Control Assign Switches: Assigns the Control Surface to Timber/Track, Audio, External, Realtime Knobs/KARMA, Tone Adjust/EQ Mixer Knobs Switch: Assigns the Mixer Knobs to either Channel Strip or Individual Pan, Reset Control Switch, Solo Switch, Knobs 1-8, Switches 1-8 (Upper Row), Switches 1-8 (Lower Row), Sliders 1-8, Master Slider KARMA Control: On/Off, Latch, Module Control		
		KARMA Controller Section	Switches = ON/OFF, LATCH, MODULE CONTROL		
		DRUM TRACK Controller Section	Switches = ON/OFF		
	Display	TouchView graphical user interface, 8 inch TFT, SVGA (800x600 dots), adjustable brightness.			
	Principal specifications	Frequency response	20 Hz–22 kHz $\pm$ 1.0 dB, 10 k $\Omega$ load		
		THD+N	20 Hz–22 kHz 0.01%, 10 k $\Omega$ load (typical)		
		Signal to noise ratio	95 dB (typical)		
		Dynamic range	95 dB (typical)		
		Crosstalk	95 dB, at 1 kHz (typical)		
	Audio Outputs	(Analog)	AUDIO OUTPUT (MAIN) L/MONO, R	1/4" TRS balanced Output Impedance: 350 $\Omega$ stereo; 175 $\Omega$ mono (L/Mono only)	
			AUDIO OUTPUT (INDIVIDUAL) 1–4	Nominal Level: +4.0 dBu	
				Maximum Level: +16.0 dBu	
				Load Impedance: 600 $\Omega$ or greater	
				MAIN VOLUME knob controls only AUDIO OUTPUT (MAIN) L/MONO and R	
			Headphones	1/4" stereo phone jack	
		Output Impedance: 33 $\Omega$ Maximum Level: 60+60 mW @33 $\Omega$ MAIN VOLUME knob (link with AUDIO OUTPUT (MAIN))			
		(Digital)	Optical S/P DIF	Format: 24 bit, S/P DIF IEC60958 EIAJCP-1201 Sample Rate: 48 kHz Digital output of the same signals as AUDIO OUTPUT (MAIN) L/MONO and R	
			USB B	Format: 24 bit Sample Rate: 48 kHz 2 channels (Digital output of the same signals as AUDIO OUTPUT (MAIN) L/MONO and R)	
		Audio Inputs	(Analog)	Audio inputs 1, 2	1/4" TRS balanced
					MIC/LINE input level switches, LEVEL knobs
	Input Impedance: 10 k $\Omega$				
	Nominal Level: LINE +4 dBu (LEVEL knob = min), -36 dBu (LEVEL knob = max)				
	Nominal Level: MIC -22 dBu (LEVEL knob = min), -62 dBu (LEVEL knob = max)				
	Maximum Level: LINE +16 dBu (LEVEL knob = min), -24 dBu (LEVEL knob = max)				
	Maximum Level: MIC -10 dBu (LEVEL knob = min), -50 dBu (LEVEL knob = max)				
	Source Impedance: 600 $\Omega$				
	Signal to noise ratio: 95 dB (typical)				
	Dynamic range: 95 dB (typical)				
	Crosstalk: 95 dB, at 1 kHz (typical)				
	(Digital)		Optical S/P DIF	Format: 24 bit, S/P DIF IEC60958 EIAJCP-1201 Sample Rate: 48 kHz	
USB B		Format: 24 bit Sample Rate: 48 kHz 2 channels			
Control Inputs	DAMPER (half damper supported) ASSIGNABLE SWITCH, ASSIGNABLE PEDAL				
MIDI	IN, OUT, THRU				
USB	USB A (TYPE A) x 2	For connection to QWERTY keyboards, MIDI controllers, ethernet adaptors, and storage devices			
	USB B (TYPE B) x 1	MIDI/audio interface MIDI: 1 (16 channel) input / 1 (16 channel) output Audio: 2 channel input / 2 channel output			
	2 USB 2.0 High-Speed ports (supports 480 Mbps)				
Disk Drive	60 GB SSD (2.5"); optional installation of second internal SSD				
Power	AC Power Supply terminal, POWER On/Off switch				

	Dimensions (W x D x H)	KRONOS2-61: 1040 x 364 x 134 (mm) / 40.94" x 14.33" x 5.28"
		KRONOS2-73: 1,221 x 371 x 148 (mm) / 48.07" x 14.61" x 5.83"
		KRONOS2-88: 1,433 x 371 x 148 (mm) / 56.42" x 14.61" x 5.83"
	Weight	KRONOS2-61: 14.3 kg / 31.53 lbs
		KRONOS2-73: 21.1 kg / 46.52 lbs
		KRONOS2-88: 24.1 kg / 53.13 lbs
	Power Consumption	60W
Accessories	AC cord, Quick Start Guide, Accessory DVD Discs 1-3 (DVDs include KRONOS Operation Guide, Parameter Guide, and Voice Name List PDF files; Video Manual; KORG USB-MIDI Driver; System Restore Data, etc.)	

## Options

<b>Hardware</b>	Expression/Volume Pedal	XVP-10
	Foot Controller	EXP-2
	Damper Pedal	DS-1H
	Pedal Switch	PS-1, PS-3
	Other	MIDI Cable
Software	EXs Expansion Samples series, KRS KRONOS Professional Sounds series	

Appearance and specifications of this product are subject to change without notice.

Since the wooden side panels of this instrument use natural wood, there will be individual differences in the wood grain and figuration.

### MIDI Implementation Chart

KRONOS

Function		Transmitted	Recognized	Remarks
Basic Channel	Default	1 - 16	1 - 16	Memorized
	Changed	1 - 16	1 - 16	
Mode	Memorized Messages Altered	×	3 ×	
Note Number:	True Voice	0 - 127 *****	0 - 127 0 - 127	All note numbers 0-127 can be transmitted by the KARMA function or as sequence data
Velocity	Note On Note Off	○ 9n, V=1 - 127 ○ 8n, V=1 - 64	○ 9n, V=1 - 127 ○ 8n, V=0 - 127	Sequencer does not record Note Off velocity.
Aftertouch	Polyphonic (Key)	○	○	Polyphonic aftertouch transmitted *A
	Monophonic (Channel)	○	○	only as sequence data *A
Pitch Bend		○	○	*C
Control Change	0, 32	○	○	Bank Select (MSB, LSB) *P
	1, 2, 16, 18	○	○	Joystick (+Y, -Y), Ribbon, Value Slider *C
	4, 5, 7, 8, 10	○	○	Pedal, Portamento Time, Volume, IFX pan, Pan *C
	11, 12, 13	○	○	Expression, Effect Control 1, 2 *C
	64, 65, 66, 67	○	○	Damper, Portamento Sw., Sostenuto, Soft *C
	70 - 79	○	○	Sound (Realtime Knobs 1-4: 74, 71, 79, 72) *C
	80, 81, 82, 83	○	○	Switch 1, 2, Foot Switch, Controller *C
	93, 91, 92, 94, 95	○	○	Send 1, 2, Effect ON/OFF (IFXs, MFXs, TFXs) *C
	14, 22 - 31, 102 - 109	○	○	KARMA Controllers *C, *2
	110 - 117, 118, 119	○	○	Pad 1-8, Vector Joystick (X, Y) *C, *2
	6, 38, 96, 97	×	○	Data Entry, Increment, Decrement *C
	98, 99, 100, 101	×	○	NRPN (LSB, MSB), RPN (LSB, MSB) *C, *3
	0 - 119	○	○	Realtime Knobs 5-8 VJS Assign *C
	0 - 119	○	○	Seq. Data, KARMA GE data output *C (Seq when received)
	0 - 119	○	○	External Mode (Knobs, SWs, Sliders) *C, *4
	120, 121	×	○	All Sound Off, Reset All Controllers *C
Program Change	Variable Range	○ 0 - 127 *****	○ 0 - 127 0 - 127	*P
System Exclusive		○	○	*E, *5
System Common	Song Position	○	○	*1
	Song Select	0 - 127	0 - 127	*1
	Tune	×	×	
System Real Time	Clock	○	○	*1
	Command	○	○	*1
Aux Messages	Local On/Off	×	○	
	All Notes Off	×	○ 123 - 127	
	Active Sense	○	○	
	Reset	×	×	

Notes \*P, \*A, \*C, \*E: Transmitted/received when Global P1: MIDI Filter (Program Change, After Touch, Control Change, Exclusive) is Enable, respectively.  
 \*1: When Global P1: MIDI Clock is Internal, transmitted but not received. The opposite for External MIDI.  
 \*2: Valid if assigned as a MIDI control change in Global P2 Controller. The number shown here is the CC default assignment.  
 \*3: RPN (LSB,MSB)=00,00: Pitch bend range, 01,00: Fine tune, 02,00: Coarse tune  
 \*4: Valid if assigned as a MIDI control change in Global P1: External 1, 2  
 \*5: In addition to Korg exclusive messages, Inquiry, GM System On, Master Volume, Master Balance, Master Fine Tune, and Master Coarse Tune are supported.

Mode 1: OMNI ON, POLY    Mode 2: OMNI ON, MONO    ○ : Yes    For more information, consult  
 Mode 3: OMNI OFF, POLY    Mode 4: OMNI OFF, MONO    × : No    your local Korg Distributor.

### **IMPORTANT NOTICE TO CONSUMERS**

This product has been manufactured according to strict specifications and voltage requirements that are applicable in the country in which it is intended that this product should be used. If you have purchased this product via the internet, through mail order, and/or via a telephone sale, you must verify that this product is intended to be used in the country in which you reside.

**WARNING:** Use of this product in any country other than that for which it is intended could be dangerous and could invalidate the manufacturer's or distributor's warranty.

Please also retain your receipt as proof of purchase otherwise your product may be disqualified from the manufacturer's or distributor's warranty.

# **KORG INC.**

4015-2 Yanokuchi, Inagi-City, Tokyo 206-0812 JAPAN

© 2011 KORG INC.