

**SPLIT TYPE  
ROOM AIR CONDITIONER**

**SLIM DUCT type  
INVERTER**

# **SERVICE INSTRUCTION**

<b>Models</b>	<b>Indoor unit</b>	<b>Outdoor unit</b>
	ARU9RLF	AOU9RLFC
	ARU12RLF	AOU12RLFC
	ARU18RLF	AOU18RLFC

*Refrigerant*  
**R410A**

# CONTENTS

## **1. DESCRIPTION OF EACH CONTROL OPERATION**

1. COOLING OPERATION.....	01-01
2. HEATING OPERATION.....	01-02
3. DRY OPERATION.....	01-02
4. AUTO CHANGEOVER OPERATION.....	01-03
5. INDOOR FAN CONTROL.....	01-04
6. OUTDOOR FAN CONTROL.....	01-06
7. COMPRESSOR CONTROL.....	01-07
8. TIMER OPERATION CONTROL.....	01-08
9. ELECTRONIC EXPANSION VALVE CONTROL.....	01-12
10. TEST OPERATION CONTROL.....	01-12
11. PREVENT TO RESTART FOR 3 MINUTES ( 3 MINUTES ST ).....	01-12
12. FOUR-WAY VALVE EXTENSION SELECT.....	01-12
13. AUTO RESTART.....	01-13
14. MANUAL AUTO OPERATION ( When using the Wireless RC ).....	01-13
15. COMPRESSOR PREHEATING.....	01-13
16. MIN.(MINIMUM) HEAT OPERATION.....	01-13
17. ECONOMY OPERATION.....	01-14
18. FRESH AIR CONTROL.....	01-14
19. EXTERNAL ELECTRICAL HEATER CONTROL.....	01-14
20. DRAIN PUMP OPERATION.....	01-15
21. DEFROST OPERATION CONTROL.....	01-16
22. OFF DEFROST OPERATION CONTROL.....	01-18
23. VARIOUS PROTECTIONS.....	01-19

## **2. TROUBLE SHOOTING**

2-1 ERROR DISPLAY.....	02-01
2-1-1 WIRED REMOTE CONTROLLER DISPLAY.....	02-01
2-2 TROUBLE SHOOTING WITH ERROR CODE.....	02-03
2-3 TROUBLE SHOOTING WITH NO ERROR CODE.....	02-25
2-4 SERVICE PARTS INFORMATION.....	02-30

## **3. APPENDING DATA**

3-1 FUNCTION SETTING.....	03-01
3-1-1 INDOOR UNIT.....	03-01
3-1-2 PROCEDURES TO CHANGE THE FUNCTION SETTING.....	03-04
3-2 THERMISTOR RESISTANCE VALUES.....	03-07
3-2-1 INDOOR UNIT.....	03-07
3-2-2 OUTDOOR UNIT.....	03-07

# ***SLIM DUCT type INVERTER***

## **1 . DESCRIPTION OF EACH CONTROL OPERATION**

# 1. COOLING OPERATION

A sensor (room temperature thermistor) built in the indoor unit body will usually perceive difference or variation between a set temperature and present room temperature, and controls the operation frequency of the compressor.

- \* If the room temperature is 4°F(2°C) higher than a set temperature, the compressor operation frequency will attain to maximum performance.
- \* If the room temperature is 5°F(2.5°C) lower than a set temperature, the compressor will be stopped.
- \* When the room temperature is between +4°F(+2°C) to -5°F(-2.5°C) of the setting temperature, the compressor frequency is controlled within the range shown in Table 1. However, the maximum frequency is limited in the range shown in Fig. 1 based on the fan speed mode and the outdoor temperature.

( Table 1 : Compressor frequency range )

	Minimum frequency	Maximum frequency I	Maximum frequency II
AOU9RLFC	10rps	74rps	57rps
AOU12RLFC	10rps	74rps	57rps
AOU18RLFC	12rps	104rps	68rps

When the compressor operates for 30 minutes continuously at over the maximum frequency II, the maximum frequency is changed from Maximum Frequency I to Maximum Frequency II.

( Fig. 1 : Outdoor temperature zone )

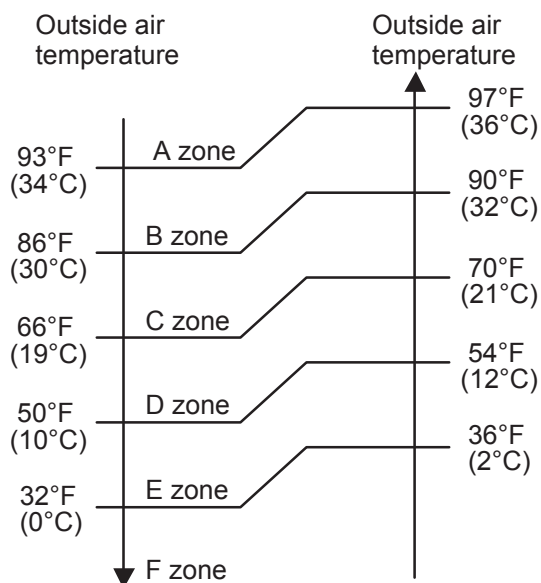

( Table 2 : Limit of maximum speed based on outdoor temperature )

	Outdoor temp. zone	Indoor fan mode			
		Hi	Me	Lo	Quiet
AOU9RLFC	A zone	74rps	49rps	44rps	35rps
	B zone	74rps	49rps	44rps	35rps
	C zone	74rps	49rps	44rps	35rps
	D zone	49rps	40rps	31rps	22rps
	E zone	49rps	40rps	31rps	22rps
	F zone	49rps	40rps	31rps	22rps
AOU12RLFC	A zone	74rps	49rps	44rps	35rps
	B zone	74rps	49rps	44rps	35rps
	C zone	74rps	49rps	44rps	35rps
	D zone	49rps	40rps	31rps	22rps
	E zone	49rps	40rps	31rps	22rps
	F zone	49rps	40rps	31rps	22rps
AOU18RLFC	A zone	104rps	59rps	48rps	30rps
	B zone	104rps	59rps	48rps	30rps
	C zone	72rps	48rps	41rps	30rps
	D zone	48rps	41rps	34rps	21rps
	E zone	48rps	41rps	34rps	21rps
	F zone	48rps	41rps	34rps	21rps

## 2. HEATING OPERATION

A sensor (room temperature thermistor) built in the indoor unit body will usually perceive difference or variation between a set temperature and present room temperature, and controls the operation frequency of the compressor.

- \* If the room temperature is lower by 6°F(3°C) than a set temperature, the compressor operation frequency will attain to maximum performance.
- \* If the room temperature is higher 5°F(2.5°C) than a set temperature, the compressor will be stopped.
- \* When the room temperature is between +5°F(+2.5°C) to -6°F(-3°C) of the setting temperature, the compressor frequency is controlled within the range shown in Table 3.

( Table 3 : Compressor frequency range )

	Minimum frequency	Maximum frequency
AOU9RLFC	10rps	119rps
AOU12RLFC	10rps	119rps
AOU18RLFC	12rps	140rps

## 3. DRY OPERATION

The compressor frequency shall change according to the temperature, set temperature, and room temperature variation which the room temperature sensor of the indoor unit body has detected as shown in the Table 4.

However, after the compressor is driven, the outdoor unit shall run at operation frequency of 40rps (9RLFC), 40rps (12RLFC), 40rps (18RLFC) for a minute.

( Table 4 : Compressor frequency in Dry mode )

		Operating frequency			Operating frequency			Operating frequency
AOU 9RLFC	X zone	35rps	AOU 12RLFC	X zone	35rps	AOU 18RLFC	X zone	30rps
	J zone	35rps		J zone	35rps		J zone	30rps
	Y zone	0rps		Y zone	0rps		Y zone	0rps

( Fig.2 : Compressor Control based on Room Temperature )

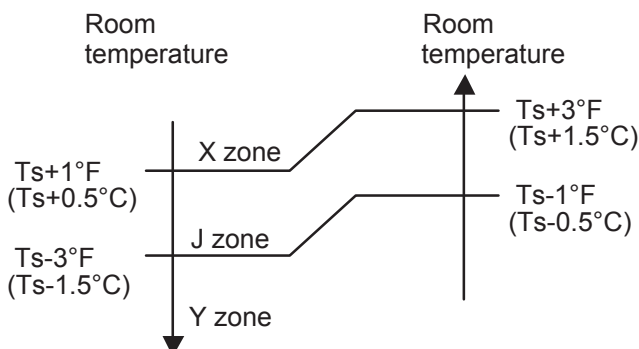

## 4. AUTO CHANGEOVER OPERATION

When the air conditioner is set to the AUTO mode by remote control, operation starts in the optimum mode from among the HEATING, COOLING, DRY and MONITORING modes. During operation, the optimum mode is automatically switched in accordance with temperature changes. The temperature can be set between 64°F(18°C) and 88°F(30°C) in 2°F(1°C) steps.

( Fig. 3 : Operation flow chart )

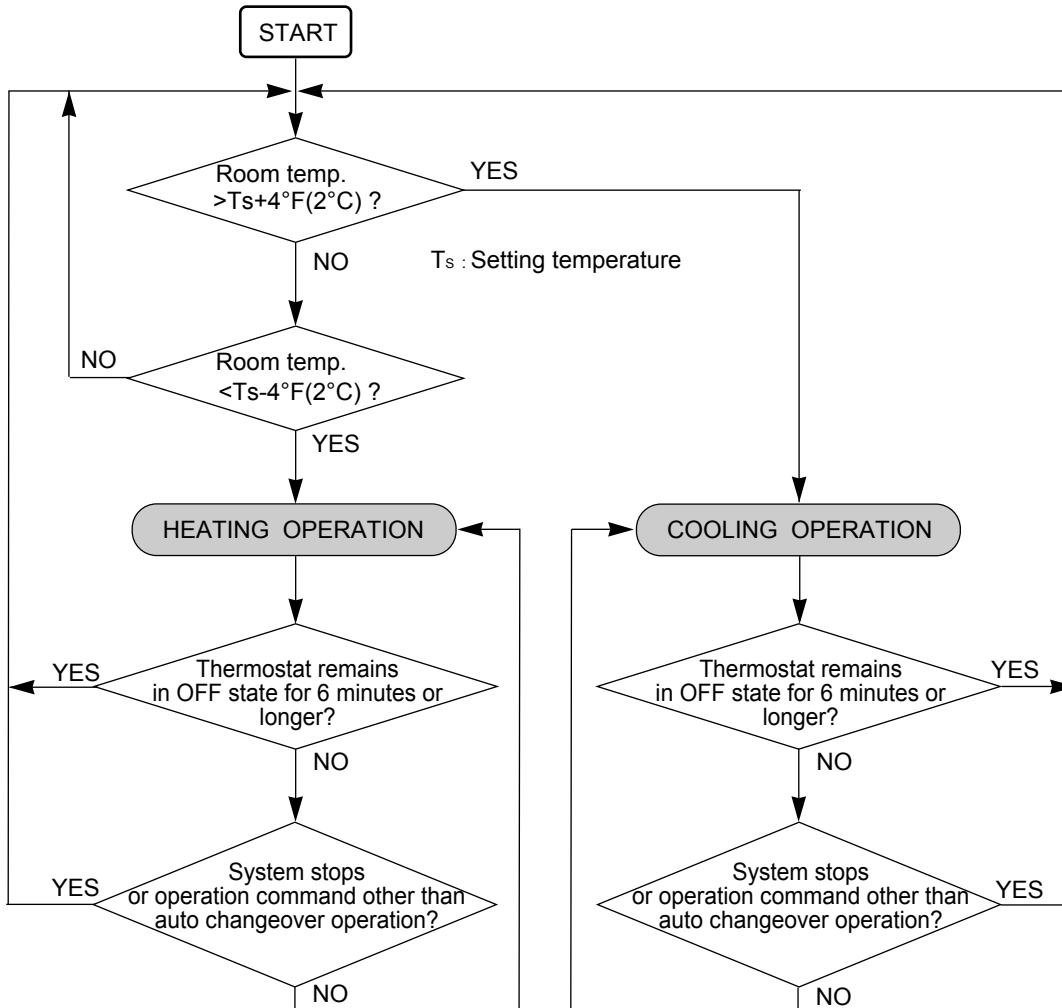

## 5. INDOOR FAN CONTROL

### 1. Fan speed

( Table 5 : Indoor fan speed )

Operation mode	Air flow mode	Speed (rpm)		
		ARU9RLF	ARU12RLF	ARU18RLF
Heating	High	1260	1340	1380
	Med	1160	1240	1300
	Low	1060	1140	1220
	Quiet	960	1030	1140
	S-Low	500	500	600
Cooling/ Fan	High	1260	1340	1380
	Med	1160	1240	1300
	Low	1060	1140	1220
	Quiet	960	1030	1140
	S-Low	500	500	600
Dry		X zone: 960 J zone: 960	X zone: 1030 J zone: 1030	X zone: 1140 J zone: 1140

### 2. FAN OPERATION

The airflow can be switched in 5 steps such as Auto, Quiet, Low, Med, High, while the indoor fan only runs.

When fan mode is set at [Auto], it operates on [Med] fan Speed.

### 3. COOLING OPERATION

Switch the airflow [Auto], and the indoor fan motor will run according to a room temperature, as shown in Fig. 4.

On the other hand, if switched in [High]~[Quiet], the indoor motor will run at a constant airflow of [Cool] operation modes Quiet, Low, Med, High, as shown in Table 5.

( Fig. 4 : Airflow change - over ( Cooling : Auto ) )

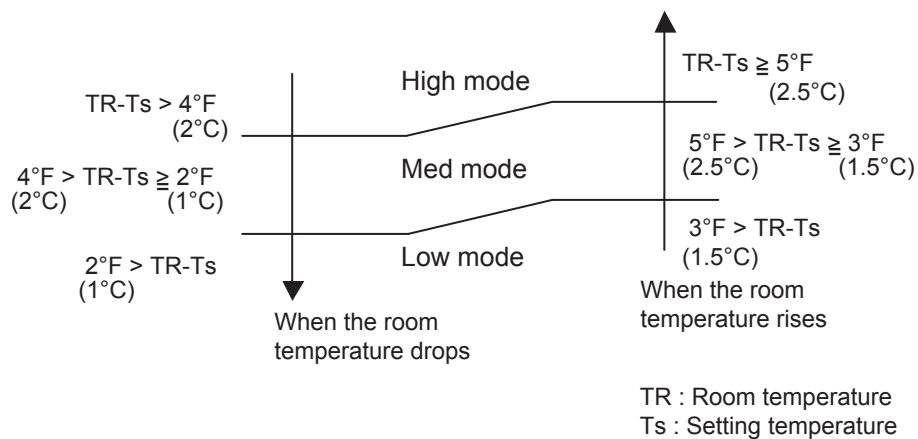

### 4. DRY OPERATION

Refer to the Table 5.

During the dry mode operation, the fan speed setting can not be changed.



## 5. HEATING OPERATION

Switch the airflow [Auto], and the indoor fan motor will run according to a room temperature, as shown in Fig. 5

On the other hand, if switched in [High] ~ [Quiet], the indoor motor will run at a constant airflow of [Heat] operation modes Quiet, Low, Med, High, as shown in Table 5.

( Fig. 5 : Airflow change - over ( Heating : Auto ) )

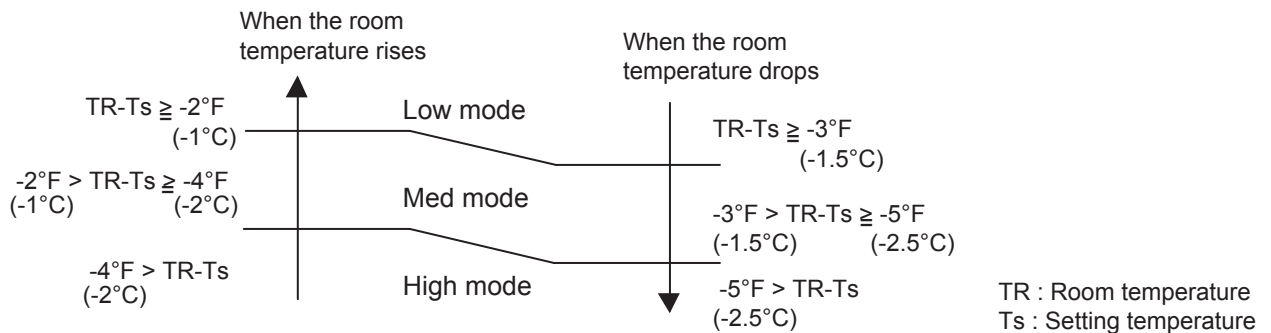

## 6. COOL AIR PREVENTION CONTROL (Heating mode)

The maximum value of the indoor fan speed is set as shown in Fig. 6 based on the detected temperature by the indoor heat-exchanger sensor on heating mode.

( Fig. 6 : Cool air prevention control )

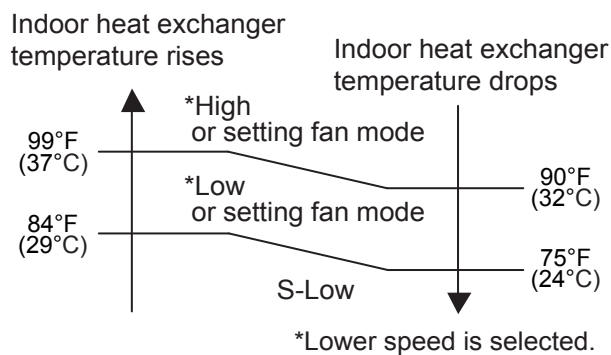

## 7. MOISTURE RETURN PREVENTION CONTROL (Cooling mode & Dry mode)

Switch the airflow "Auto" at cooling mode, and the indoor fan motor will run as shown in Fig. 7.

( Fig. 7 : Indoor fan control )

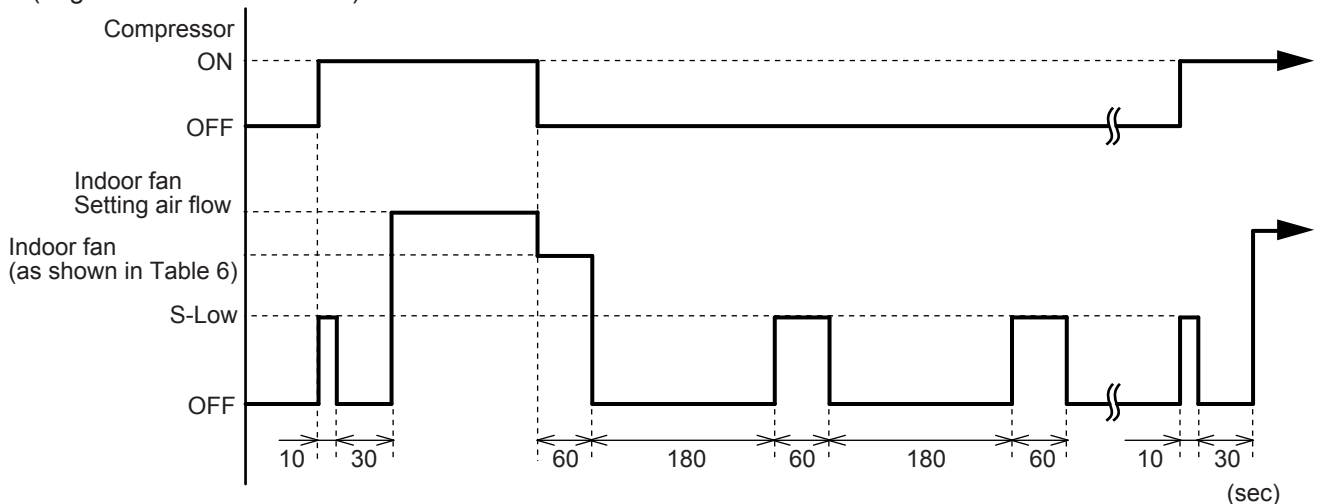

( Table 6 : Indoor fan speed )

	Dry		Cooling
	X zone	J zone	
ARU9RLF	960rpm	960rpm	960rpm
ARU12RLF	1030rpm	1030rpm	1030rpm
ARU18RLF	1140rpm	1140rpm	1140rpm

## 6. OUTDOOR FAN CONTROL

### 1. Outdoor Fan Motor

Table 7 shows the type of the outdoor fan motor. The control method is different between AC motor and DC motor.

( Table 7 : Type of Motor )

	AC Motor	DC Motor
AOU9 / 12 / 18RLFC		○

### 2. Fan Speed

( Table 8 : Outdoor fan speed )

(rpm)

	Zone ※	Cooling	Dry	Heating
AOU9RLFC	Y	1050/ 870/ 720/ 590/ 530	530	1100/ 870/ 780/ 720/ 590/ 480
	Z	870/530/300		
	F	300/ 250	300/ 250	
	G	250/ 200	250/ 200	
AOU12RLFC	Y	1050/ 870/ 720/ 590/ 530	530	1100/ 870/ 780/ 720/ 590/ 480
	Z	870/530/300		
	F	300/ 250	300/ 250	
	G	250/ 200	250/ 200	
AOU18RLFC	Y	1050/ 870/ 720/ 530	530	1100/ 1000/ 780/ 720/ 590/ 480
	Z	870/ 530/ 300		
	F	300	300	
	G	250/ 200	250/ 200	

※ Refer to Fig. 8

( Fig. 8 : Outside air temperature zone selection )

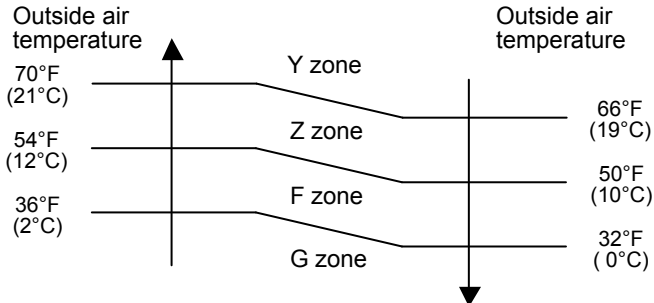

- \* The outdoor fan speed mentioned above depends on the compressor frequency. (When the compressor frequency increases, the outdoor fan speed also changes to the higher speed. When the compressor frequency decreases, the outdoor fan speed also changes to the lower speed.)
- \* After the defrost control is operated on the heating mode, the fan speed keeps at the higher speed as Table 9 without relating to the compressor frequency.

( Table 9 : Outdoor fan speed after the defrost )

AOU9RLFC	1100rpm
AOU12RLFC	1100rpm
AOU18RLFC	1100rpm

# 7. COMPRESSOR CONTROL

## 1. OPEARTION FREQUENCY RANGE

The operation frequency of the compressor is different based on the operation mode as shown in the Table 10.

(Table 10 : Compressor frequency range)

	Cooling / Dry		Heating	
	Minimum	Maximum	Minimum	Maximum
AOU9RLFC	10rps	74rps	10rps	119rps
AOU12RLFC	10rps	74rps	10rps	119rps
AOU18RLFC	12rps	104rps	16rps	140rps

## 2. OPEARTION FREQUENCY CONTROL AT NORMAL START UP

The compressor frequency soon after the start-up is controlled as shown in the Fig. 9

(Fig. 9 : Compressor control at start-up)

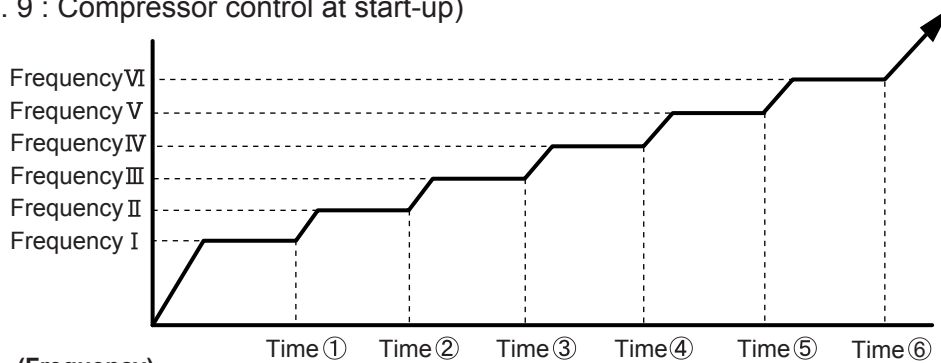

(Frequency)

	Frequency I	Frequency II	Frequency III	Frequency IV	Frequency V	Frequency VI
AOU9RLFC	40rps	57rps	72rps	80rps	101rps	110rps
AOU12RLFC	40rps	59rps	72rps	80rps	101rps	110rps

(Time)

	Time ①	Time ②	Time ③	Time ④	Time ⑤	Time ⑥
AOU9RLFC	80sec	110sec	140sec	200sec	350sec	410sec
AOU12RLFC	80sec	110sec	140sec	200sec	350sec	410sec
AOU18RLFC	80sec	110sec	140sec	200sec	350sec	410sec

## 3. LIMITATION OF COMPRESSOR FREQUENCY BY OUTDOOR TEMPERATURE

The minimum compressor frequency is limited by outdoor temperature as shown in the Table 11.

(Table 11 : Limitation of Compressor Frequency)

### [ Cooling/ Dry ]

	50°F(10°C)		57°F(14°C)		104°F(40°C)	
	Under	Over	Under	Over	Under	Over
AOU9RLFC	35rps	18rps	10rps	15rps		
AOU12RLFC						

### [ Heating ]

	23°F(- 5°C)		37°F(3°C)		45°F(7°C)		64°F(18°C)	
	Under	Over	Under	Over	Under	Over	Under	Over
AOU9RLFC	35rps	29rps	18rps	10rps				
AOU12RLFC								

### [ Cooling/ Dry ]

	32°F(0°C)		50°F(10°C)		104°F(40°C)	
	Under	Over	Under	Over	Under	Over
AOU18RLFC	24rps	18rps	12rps	16rps		

### [ Heating ]

	37°F(3°C)		45°F(7°C)	
	Under	Over	Under	Over
AOU18RLFC	24rps	18rps	16rps	

## 8. TIMER OPEARTION CONTROL

### 8-1 WIRELESS REMOTE CONTROLLER (OPTION)

The Table 12 shows the available timer setting based on the product model.

( Table 12 : Timer Setting )

	ON TIMER / OFF TIMER	PROGRAM TIMER	SLEEP TIMER
ARU9/ 12/ 18RLF	○	○	○

#### 1. ON TIMER/ OFF TIMER

- OFF timer : When the clock reaches the set time, the air conditioner will be turned off.

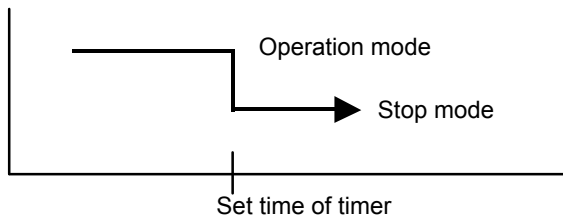

- ON timer : When the clock reaches the set time, the air conditioner will be turned on.

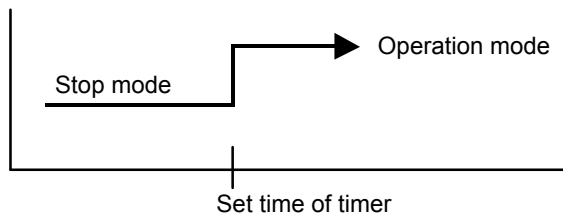

#### 2. PROGRAM TIMER

- The program timer allows the OFF timer and ON timer to be used in combination one time.

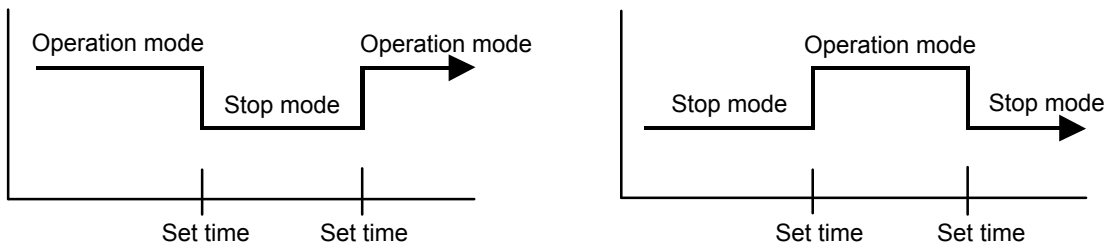

- Operation will start from the timer setting (either OFF timer or ON timer) whichever is closest to the clock's current timer setting.  
The order of operations is indicated by the arrow in the remote control unit's display.
- SLEEP timer operation cannot be combined with ON timer operation.

### 3. SLEEP TIMER

If the sleep is set, the room temperature is monitored and the operation is stopped automatically. If the operation mode or the set temperature is change after the sleep timer is set, the operation is continued according to the changed setting of the sleep timer from that time ON.

#### In the cooling operation mode

When the sleep timer is set, the setting temperature is increased  $2^{\circ}\text{F}(1^{\circ}\text{C})$ . It increases the setting temperature another  $2^{\circ}\text{F}(1^{\circ}\text{C})$  after 1 hour. After that, the setting temperature is not changed and the operation is stopped at the time of timer setting.

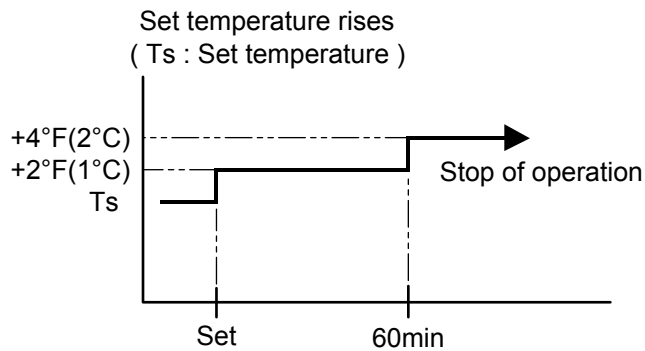

#### In the heating operation mode

When the sleep timer is set, the setting temperature is decreased  $2^{\circ}\text{F}(1^{\circ}\text{C})$ . It decreases the setting temperature another  $2^{\circ}\text{F}(1^{\circ}\text{C})$  every 30 minutes. Upon lowering  $8^{\circ}\text{F}(4^{\circ}\text{C})$ , the setting temperature is not changed and the operation stops at the time of timer setting.

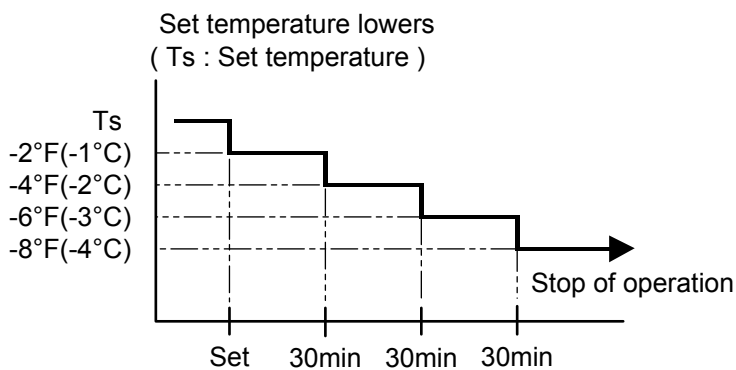

## 8-2 WIRED REMOTE CONTROLLER

The Table 13 shows the available timer setting based on the product model.

( Table 13 : Timer Setting )

	ON TIMER / OFF TIMER	WEEKLY TIMER	TEMPERATURE SET BACK TIMER
ARU9/ 12/ 18RLF	○	○	○

### 1. ON / OFF TIMER

- OFF timer : When the clock reaches the set time, the air conditioner will be turned off.

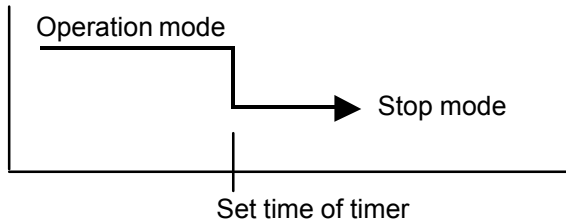

- ON timer : When the clock reaches the set time, the air conditioner will be turned on.

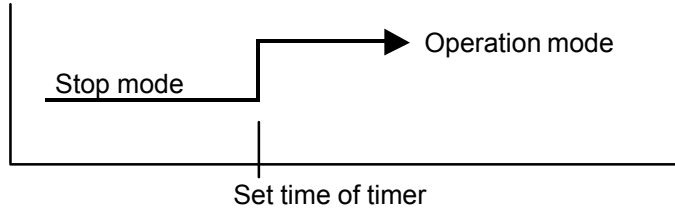

### 2. WEEKLY TIMER

#### 2-1. WEEKLY TIMER

- Use this timer function to set operating time for each day of the week.
- The weekly timer allows up to two ON and OFF time to set up per day.

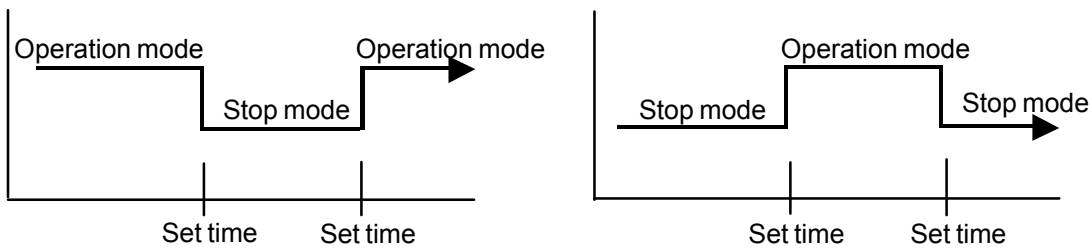

- The operating time can be set in 30 min increments only.
- The OFF time can be carried over to next day.
- The ON timer and the OFF timer functions cannot be set with using the weekly timer. Both ON and OFF time must be set.

## 2-2. DAY OFF setting

- The DAY OFF setting is only available for days for which weekly settings already exist.
- If the operating time carries over to the next day (during a next day setting), the effective DAY OFF range will be set as shown below.

- Normal

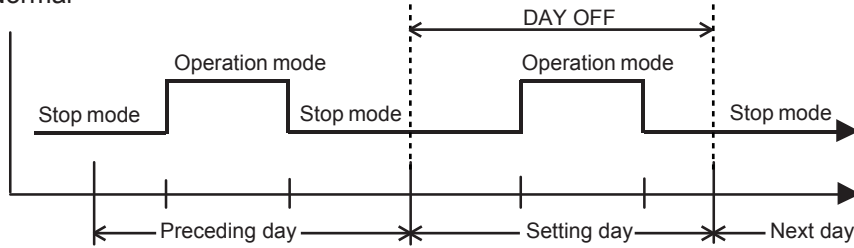

- Next day setting

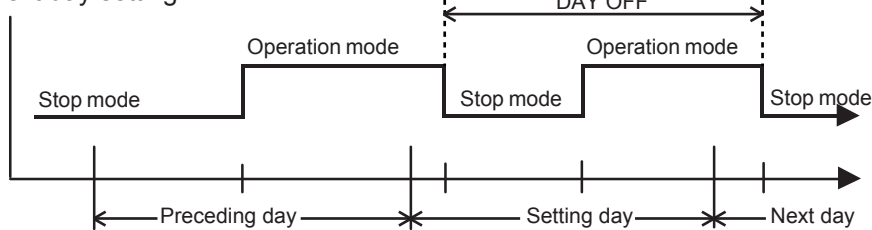

- The DAY OFF setting can only be set one time. The DAY OFF setting is cancelled automatically after the set day has passed.

## 3. TEMPERATURE SET BACK TIMER

- The SET BACK timer only changes the set temperature for 7 days, it cannot be used to start or stop air conditioner operation.
- The SET BACK timer can be set to operate up to two times per day but only one temperature setting can be used.
- During COOLING/DRY mode, the air conditioner will operate at a minimum of 64°F(18°C) even if the SET BACK temperature is set to 63°F(17°C) or lower.

Case of SET BACK timer on the Cooling operation.

( Setting temperature :72°F(22°C), SET BACK temperature :78°F(26°C))

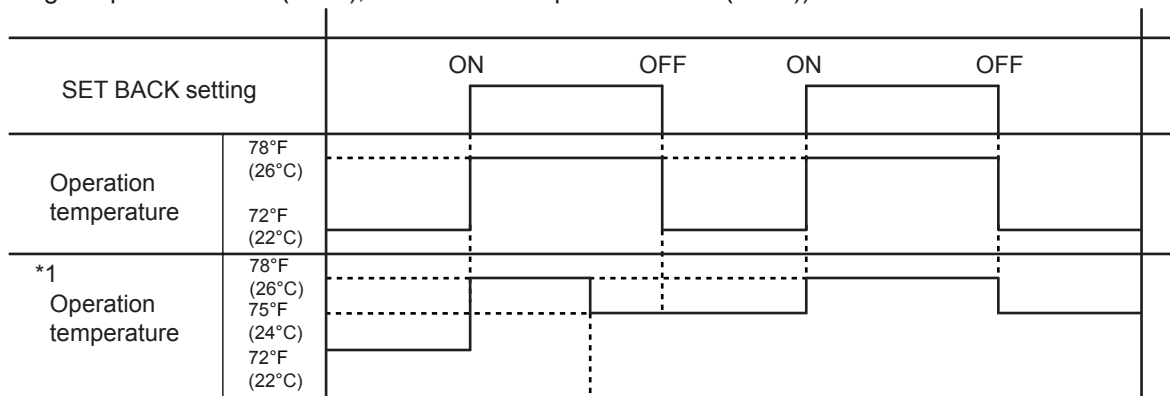

\*1: During the SET BACK function, the setting temperature is changed.

↑  
Change the setting temperature:  
72°F(22°C) → 75°F(24°C)

## 9. ELECTRONIC EXPANSION VALVE CONTROL

The most proper opening of the electronic expansion valve is calculated and controlled under the present operating condition based on the Table 14.

The compressor frequency, the detected temperature by the discharge temperature sensor, the indoor heat exchanger sensor, the outdoor heat exchanger sensor, and the outdoor temperature sensor.

( Table 14 : The pulse range of the electronic expansion valve control )

	Operation mode	Pulse range
AOU9RLFC AOU12RLFC	Cooling / Dry mode	Between 60 to 480 pulses.
	Heating mode	Between 45 to 480 pulses.
AOU18RLFC	Cooling / Dry mode	Between 60 to 480 pulses.
	Heating mode	

- \* The expansion valve is set at 480 pulses 110seconds after the compressor had stopped.
- \* Initialization will start after 24 hours pass from the last initialization, and the compressor stops
- \* At the time of supplying the power to the outdoor unit, the initialization of the electronic expansion valve is operated (528 pulses are input to the closing direction).

## 10. TEST OPERATION CONTROL

### [ Wireless remote controller (Option) ]

Under the condition where the air conditioner runs, press the TEST RUN button of the remote control, and the test operation control mode will appear.

During test running, the operation lamp and timer lamp of the air conditioner body twinkle simultaneously.

### [ Wired remote controller ]

If the operation lamp is on, press the START/STOP button to turn it off.

Press the MODE and FAN buttons at the same time for more than two seconds to start the test operation.

The operation lamp will light up and "o1" will be displayed on the set temperature display.

### [ Release ]

Perform the test operation for 60 minutes.

Pressing the START/STOP button will stop the test operation.

## 11. PREVENT TO RESTART FOR 3 MINUTES ( 3 MINUTES ST )

The compressor won't enter operation status for 2 minutes and 20 seconds after the compressor is stopped, even if any operation is given.

## 12. FOUR-WAY VALVE EXTENSION SELECT

At the time when the air conditioner is switched from the cooling mode to heating mode, the compressor is stopped, and the four-way valve is switched in 2 minutes and 20 seconds later after the compressor stopped.



## 13. AUTO RESTART

When the power was interrupted by a power failure, etc. during operation, the operation contents at that time are memorized and when power is recovered, operation is automatically started with the memorized operation contents.

(Table 15 : Operation contents memorized when the power is interrupted)

	Wireless remote controller	Wired remote controller (Memory Backup : Disable)	Wired remote controller (Memory Backup : Enable)	
Operation mode Set temperature Set air flow Set air flow direction Swing Economy operation MIN.Heat operation	○	○	○	
Thermistor detected position	—	×	○	
Timer mode	○	×	OFF Timer	×
			ON Timer	×
			WEEKLY Timer	○
			Temperature SET BACK Timer	○

○ : Memorize  
× : Not memorize

\*It is necessary to set on the DIP-SW1-No,6 of the wired remote controller, to enable the memory backup. Refer to the installation manual of wired remote controller for details.

## 14. MANUAL AUTO OPERATION (When using the Wireless RC)

If MANUAL AUTO Button is set, the operation is controlled as shown in Table 16.

If the remote control is lost or battery power dissipated, this function will work without the remote control.

(Table 16 : MANUAL AUTO OPERATION)

	Manual auto operation
OPERATION MODE	Auto changeover
FAN CONT. MODE	Auto
TIMER MODE	Continuous (No timer setting available)
SETTING TEMP.	75°F(24°C)
ECONOMY	OFF

## 15. COMPRESSOR PREHEATING

When the outdoor heat exchanger temperature is lower than 41°F(5°C) and the all operation has been stopped for 30 minutes, power is applied to the compressor and the compressor is heated. (By heating the compressor, warm air is quickly discharged when operation is started.)

When operation was started, and when the outdoor heat exchanger temperature rises to 44.6°F(7°C) or greater, preheating is ended.

## 16. MIN. (MINIMUM) HEAT OPERATION

MIN. HEAT OPERATION performs as below when pressing MIN. HEAT button or Weekly timer setting on the remote controller.

(Table 17 : MIN. HEAT OPERATION)

Mode	Heating
Setting temperature	50°F(10°C)
Fan mode	Auto
LED display	Economy
Defrost operation	Operate as normal

## 17. ECONOMY OPERATION

The ECONOMY operation functions by pressing ECONOMY button on the remote controller. At the maximum output, ECONOMY Operation is approximately 70% of normal air conditioner operation for cooling and heating.

The ECONOMY operation is almost the same operation as below settings.

( Table 18 )

Mode	Cooling/ Dry	Heating
Target temperature	Setting temp.+2°F(+1°C)	Setting temp.-2°F(-1°C)

## 18. FRESH AIR CONTROL

The fan motor for Fresh Air(Field supply) is operated in synchronization with the indoor fan operation as shown in Fig. 10.

(Fig. 10 : Fresh air control)

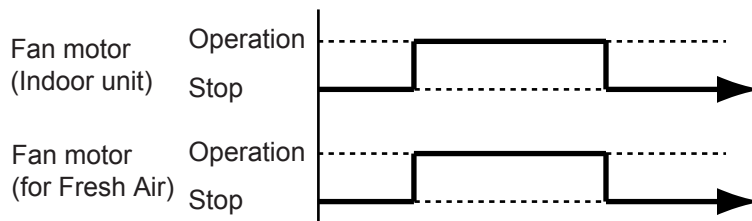

## 19. EXTERNAL ELECTRICAL HEATER CONTROL

The external electrical heater(Field supply) is operated as shown in Fig. 11.

(Fig.11 : External electrical heater control)

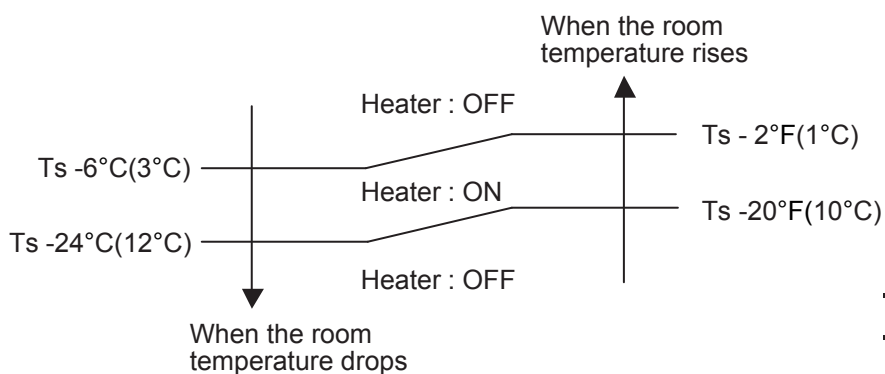

- Ts : Setting temperature
- When the compressor stop, External electrical heater is OFF.

## 20. DRAIN PUMP OPERATION

### During Cooling / Dry mode

1. When the compressor starts, the drain pump starts simultaneously.
2. The drain pump operates continuously for 3 minutes after the compressor is turned off.
3. When the compressor stops by the "Anti- freezing protection", the drain pump is turned off in 1 hour after the compressor stops.
4. When the water level in the drain pan rises up and then the float switch functions:
  - ① The compressor, indoor and outdoor fan motor operation are stopped.
  - ② Drain pump operates continuously for 3 minutes after the float switch is turned off. (Almost condensing water may be drained)
  - ③ The indoor unit fan motor operates after the float switch is turned off.
5. When the float switch turns ON continuously for 3 minutes, "FAILURE INDICATION" operates. (It is necessary to turn off power for release it. )
6. When the float switch turns OFF less than 3 minutes, the unit starts Cooling operation.

( Fig. 12 : Detail of Drain Pump Operation in Cooling / Dry )

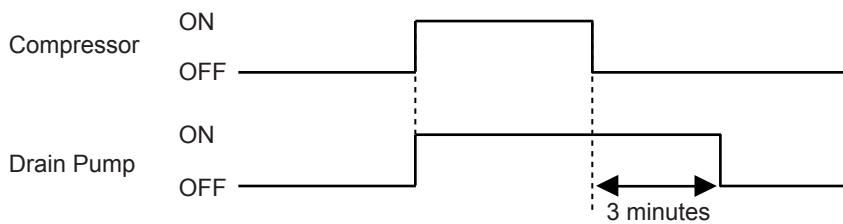

### <Float Switch turns OFF less than 3 minutes>

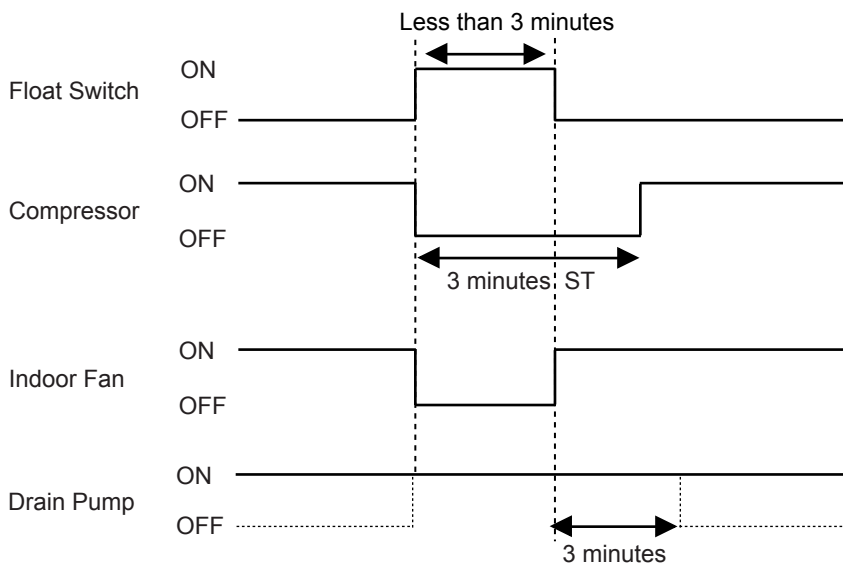

### During HEATING / FAN mode / Stop operation

1. When the water level in the drain pan rises up and then the float switch functions:
 

Drain pump operates continuously for 3 minutes after the float switch is turned off.  
(Almost condensing water may be drained)
2. When the float switch turns ON continuously for 3 minutes, "FAILURE INDICATION" operates. Thereafter, even if the float switch turns OFF, the "FAILURE INDICATION" is not released. (It is necessary to turn off power for release it. )

( Fig. 13 : Detail of Drain Pump Operation in Heating )

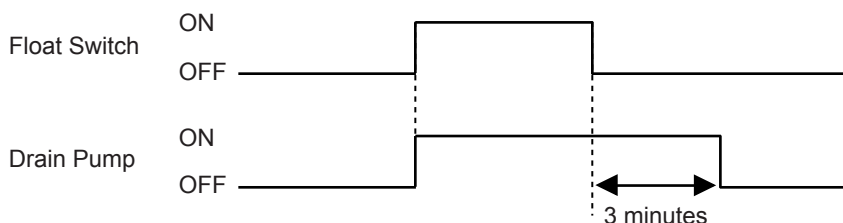

## 21. DEFROST OPERATION CONTROL

### 1. CONDITION OF STARTING THE DEFROST OPERATION

The defrost operation starts as shown in the following Table 19.

(Table 19 : Condition of starting Defrost Operation)

Normal defrost	Compressor integrating operation time	
	Less than 25 minutes (9/ 12RLFC) Less than 40 minutes (18RLFC)	More than 25 minutes (9/ 12RLFC) More than 40 minutes (18RLFC)
	Does not operate	Outdoor heat exchanger temp. $\leq 1.4^{\circ}\text{F}(-17^{\circ}\text{C})$ (at outside air temp. $\geq 14^{\circ}\text{F}(-10^{\circ}\text{C})$ ) ----- Outdoor heat exchanger temp. $\leq$ Outside air temp. $-(12.6^{\circ}\text{F} (7^{\circ}\text{C}))$ or Outdoor heat exchanger temp. $\leq -13^{\circ}\text{F} (-25^{\circ}\text{C})$ (at $-4^{\circ}\text{F} (-20^{\circ}\text{C}) \leq$ Outside air temp. $< 14^{\circ}\text{F} (-10^{\circ}\text{C})$ ) ----- Outdoor heat exchanger temp. $\leq$ Outside air temp. $-(12.6^{\circ}\text{F} (7^{\circ}\text{C}))$ or Outdoor heat exchanger temp. $< -22^{\circ}\text{F}(- 30^{\circ}\text{C})$ (at outside air temp. $\leq -4^{\circ}\text{F}(-20^{\circ}\text{C})$ )

Integrating defrost	Compressor integrating operation time		
	More than 240 minutes (For continuous operation)	More than 213 minutes (For continuous operation)	Less than 10 minutes* ( For intermittent operation )
	Outdoor heat exchanger temperature below $26.6^{\circ}\text{F}(-3^{\circ}\text{C})$	Outdoor heat exchanger temperature below $23^{\circ}\text{F}(-5^{\circ}\text{C})$	OFF count of the compressor 40 times

\*If the compressor continuous operation time is less than 10 minutes, the OFF number of the compressor is counted.  
If any defrost operated, the compressor OFF count is cleared.

### 2. CONDITION OF THE DEFROST OPERATION COMPLETION

Defrost operation is released when the conditions become as shown in Table 20.

(Table 20 : Defrost Release Condition)

Release Condition
Outdoor heat exchanger temperature sensor value is higher than $+16^{\circ}\text{C}(60.8^{\circ}\text{F})$ or Compressor operation time has passed 15 minutes.

### 3. Defrost Flow Chart

The defrosting shall proceed by the integrating operation time, outdoor temperature and outdoor heat exchanger temperature as follows.

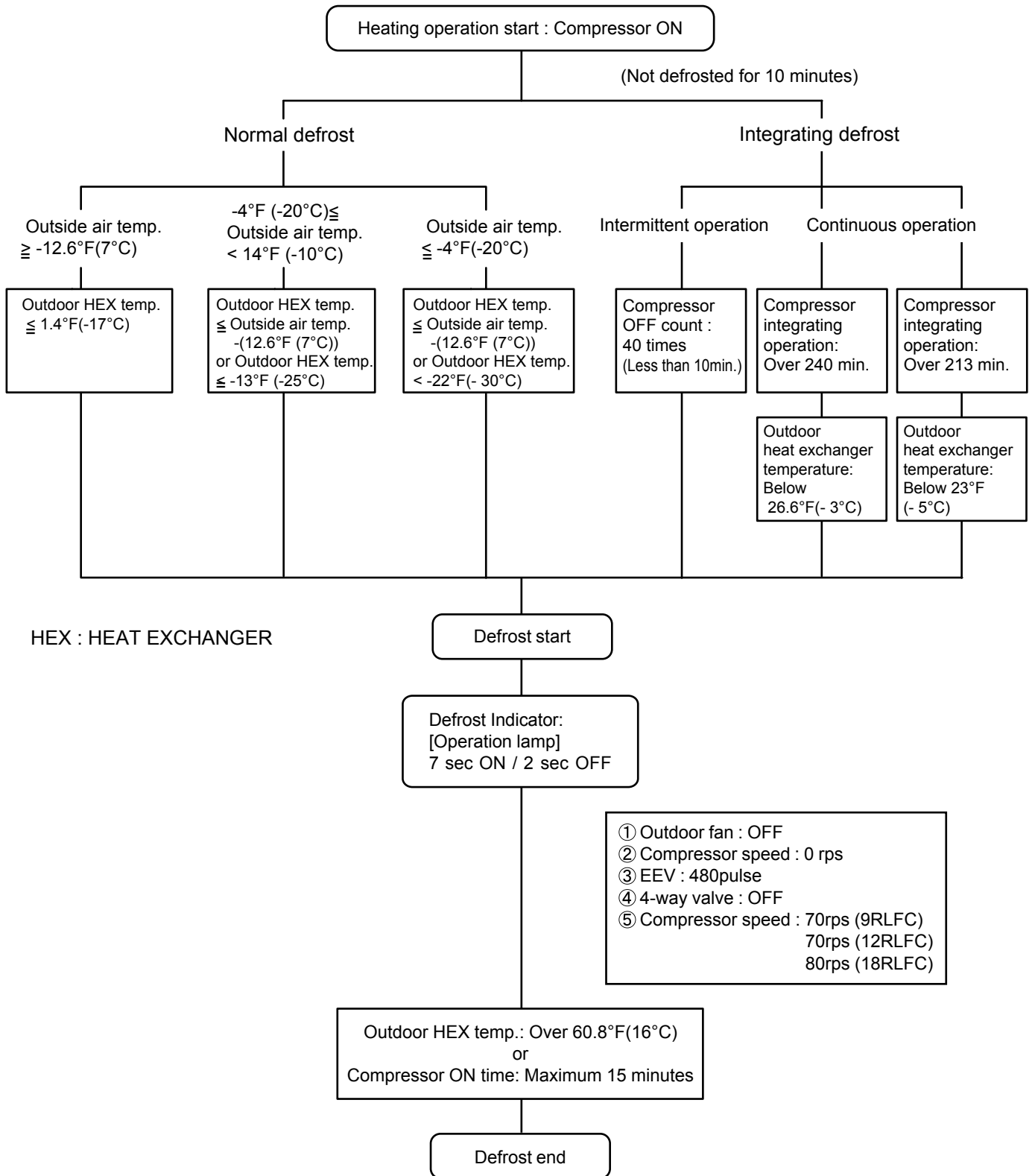

## 22. OFF DEFROST OPERATION CONTROL

When operation stops in the [Heating operation] mode, if frost is adhered to the outdoor unit heat exchanger, the defrost operation will proceed automatically. In this time, if indoor unit operation lamp flashes slowly (7 sec ON / 2 sec OFF), the outdoor unit will allow the heat exchanger to defrost, and then stop.

### 1. OFF DEFROST OPERATION CONDITION

In heating operation, the outdoor heat exchanger temperature is less than 24.8°F(- 4°C), compressor continuous operation more than 10 minutes, and compressor operation integrating time lasts for more than 30 minutes.

### 2. OFF DEFROST END CONDITION

Release Condition
Outdoor heat exchanger temperature sensor value is higher than 60.8°F(16°C) or Compressor operation time has passed 15 minutes.

### OFF Defrost Flow Chart

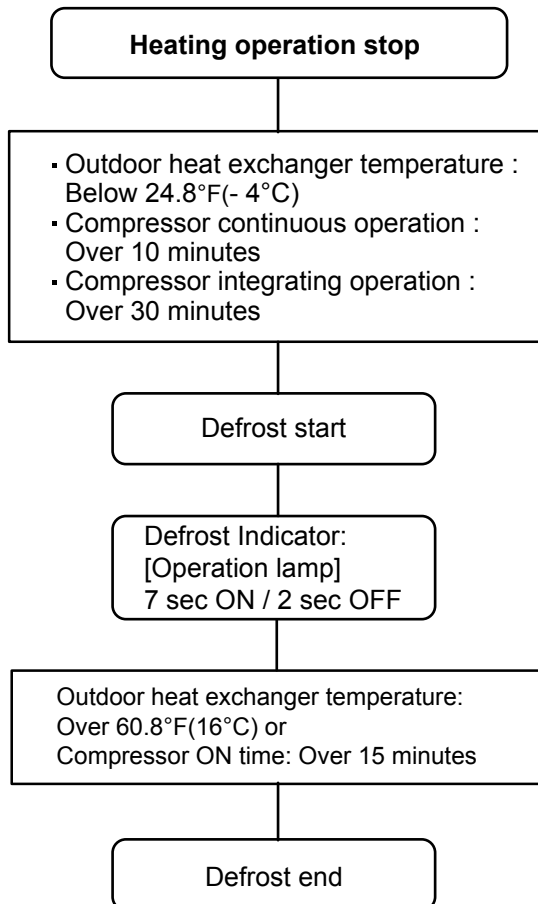

## 23. VARIOUS PROTECTIONS

### 1. DISCHARGE GAS TEMPERATURE OVERRISE PREVENTION CONTROL

The discharge gas thermosensor (discharge thermistor : Outdoor side) will detect discharge gas temperature.

When the discharge temperature becomes higher than Temperature I, the compressor frequency is decreased 20rps, and it continues to decrease the frequency for 20rps every 120 seconds until the temperature becomes lower than Temperature I.

When the discharge temperature becomes lower than Temperature II, the protection control of the compressor frequency will be released.

When the discharge temperature becomes higher than Temperature III, the compressor is stopped and the indoor unit LED starts blinking.

( Table 21 : Discharge temperature over rise prevention control / Release temperature )

Temperature I	Temperature II	Temperature III
219.2°F (104°C)	213.8°F (101°C)	230°F (110°C)

### 2. CURRENT RELEASE CONTROL

The compressor frequency is controlled so that the outdoor unit input current does not exceed the current limit value that was set up with the outdoor temperature.

The compressor frequency returns to the designated frequency of the indoor unit at the time when the frequency becomes lower than the release value.

( Table 22 : Current release operation value / Release value )

#### [ Heating ]

AOU9 / 12RLFC	
OT (Control / Release)	
62.6°F (17°C)	7.0A / 6.5A
53.6°F (12°C)	9.0A / 8.5A
41°F (5°C)	10.0A / 9.5A

OT : Outdoor Temperature

#### [ Heating ]

AOU18RLFC	
OT (Control / Release)	
62.6°F (17°C)	7.0A / 6.5A
53.6°F (12°C)	9.0A / 8.5A
41°F (5°C)	11.0A / 10.5A
	13.0A / 12.5A

OT : Outdoor Temperature

#### [ Cooling ]

AOU9 / 12RLFC	
OT (Control / Release)	
114.8°F (46°C)	4.5A / 4.0A
104°F (40°C)	6.0A / 5.5A
	8.5A / 8.0A

OT : Outdoor Temperature

#### [ Cooling ]

AOU18RLFC	
OT (Control / Release)	
114.8°F (46°C)	4.5A / 4.0A
104°F (40°C)	6.0A / 5.5A
	9.0A / 8.5A

OT : Outdoor Temperature

### 3. ANTIFREEZING CONTROL (Cooling and Dry mode)

The compressor frequency is decrease on cooling & dry mode when the indoor heat exchanger temperature sensor detects the temperature lower than Temperature I. Then, the anti-freezing control is released when it becomes higher than Temperature II.

(Table 23 : Anti-freezing Protection Operation / Release Temperature)

Outdoor temperature	Temperature I	Temperature II
Over than 50°F(10°C) *1 or 54°F(12°C) *2	39.2°F (4°C)	44.6°F (7°C)
Less than 50°F(10°C) *1 or 54°F(12°C) *2		55.4°F (13°C)

\*1. When the temperature drops.

\*2. When the temperature rises.

### 4. COOLING PRESSURE OVERRISE PROTECTION

When the outdoor unit heat exchange sensor temperature rises to 152.6°F(67°C) or greater, the compressor and the outdoor fan motor are stopped and trouble display is performed.

### 5. HIGH TEMPERATURE RELEASE CONTROL ( HEATING MODE )

On heating mode, the compressor frequency is controlled as following based on the detection value of the indoor heat exchanger temperature sensor.

[ Control System ]

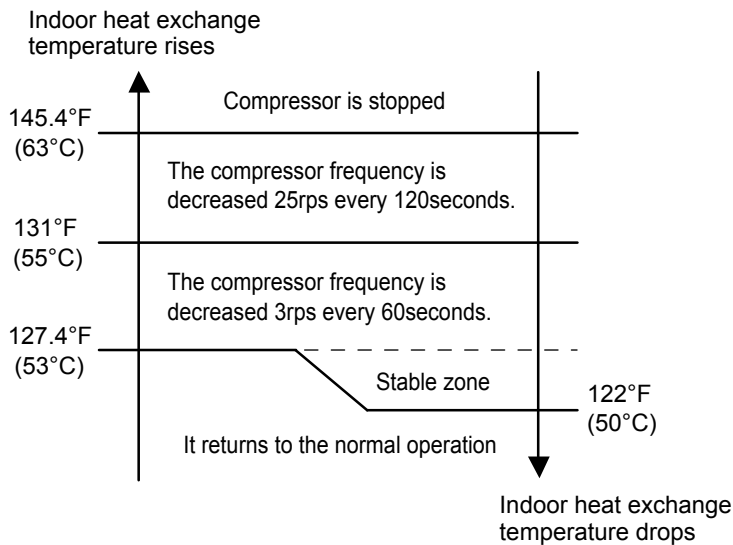



# ***SLIM DUCT type INVERTER***

## **2 . TROUBLE SHOOTING**

## 2-1 ERROR DISPLAY

### 2-1-1 WIRED REMOTE CONTROLLER DISPLAY

#### 1. SELF - DIAGNOSIS

When "Er" in Temperature Display is displayed, inspection of the air conditioning system is necessary. Please consult authorized service personnel.

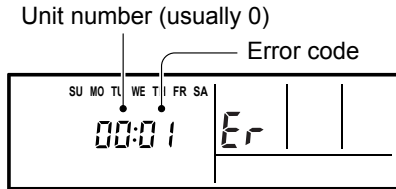

ex. Self-diagnosis check

Error Contents	Error Code	Trouble shooting
Serial Communication Error	11	1-1,1-2
Wired Remote Controller Communication Error	12	2
Indoor unit model information error EEPROM access abnormal	32	3
Manual auto switch error	35	4
Indoor room thermistor error	41	5
Indoor heat Ex.(Pipe) thermistor error	42	6
Indoor unit fan motor error	51	7
Drain pump error	53	8
Indoor unit error	5U	1- 8
Outdoor unit main PCB error	62	9
PFC circuit error (9 / 12RLFC) Active filter error (18RLFC)	64	10
IPM Error	65	11
Discharge thermistor error	71	12
Heat Ex. (Pipe) thermistor error	73	13
Outdoor thermistor error	74	14
Current sensor error	84	15

Error Contents	Error Code	Trouble shooting
Over current error	94	16
Compressor control error	95	17
Outdoor unit fan motor error	97	18
4 Way valve error	99	19
Discharge temp. error	A1	20

## 1. SELF - DIAGNOSIS

When "Er" in Temperature Display is displayed, inspection of the air conditioning system is necessary. Please consult authorized service personnel.

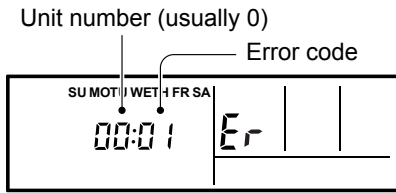

ex. Self-diagnosis check

## 2. ERROR CODE HISTORY DISPLAY

Up to 16 memorized error codes may be displayed for the indoor unit connected to the remote controller.

1. Stop the air conditioner operation.

2. Press the SET TEMPERATURE buttons  $\nabla$ ,  $\blacktriangle$  simultaneously for 3 seconds or more to start the self-diagnosis.

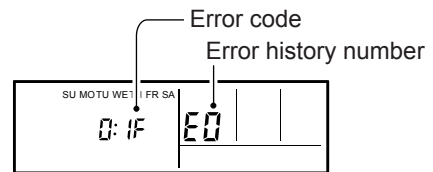
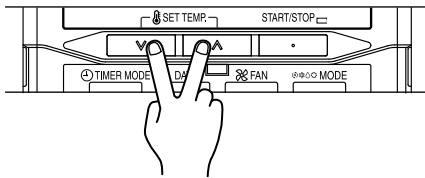

3. Press the SET TEMPERATURE button to select the error history number.

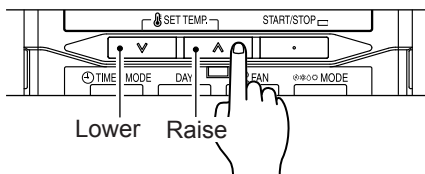

0 ↔ 1 ↔ 2 ↔ 3 ↔ 4 ↔ 5 ↔ 6 ↔ 7  
F ↔ E ↔ d ↔ c ↔ b ↔ A ↔ 9 ↔ 8

4. Press the SET TEMPERATURE buttons  $\nabla$ ,  $\blacktriangle$  simultaneously for 3 seconds or more or there is no key input for 60 seconds to stop the display.

## 2-2 TROUBLE SHOOTING WITH ERROR CODE

**Trouble shooting 1-1**  
**OUTDOOR UNIT Error Method:**  
**Serial communication error**  
**(Serial Reverse Transfer Error)**

**Indicate or Display:**

Refer to error code table.

**Detective Actuators:**

Outdoor unit Main PCB  
 Outdoor unit fan motor

**Detective details:**

When the indoor unit cannot receive the serial signal from Outdoor unit more than 2minutes after power ON, or the indoor unit cannot receive the serial signal more than 15seconds during normal operation.

**Forecast of Cause:**

1. Connection failure
2. External cause
3. Main PCB failure
4. Active filter module failure
5. Transistor PCB (IPM) failure
6. Filter PCB failure
7. Outdoor unit Fan motor failure

Check Point 1-1 : Reset the power and operate

· Does Error indication show again?

NO

YES

Check Point 2 : Check Connection

· Check any loose or removed connection line of Indoor unit and Outdoor unit.  
 >> **If there is an abnormal condition, correct it by referring to Installation Manual or Data & Technical Manual.**

Check Point 1-2: Check external cause such as noise

· Check the complete insulation of the grounding.  
 · Check if there is any equipment that causes harmonic wave near the power cable (Neon light bulb or any electronic equipment which causes harmonic wave).

OK

Check Point 3 : Check the voltage of power supply

· Check the voltage of power supply  
 >> **Check if AC187V (AC208V -10%) - 253V (AC230V +10%) appears at Outdoor Unit Terminal L - N.**

AC

OK

Check Point 4 : Check Serial Signal (Reverse Transfer Signal)

· Check serial signal (Reverse transfer signal)  
 >> **Check if indicated value swings between AC90V and AC270V at outdoor unit terminal 1 - 3.**  
 >> **If it is abnormal, Check the parts as follows.**

- Outdoor unit fan motor (PARTS INFORMATION 5)
- Active filter module (PARTS INFORMATION 6) \*For AOU18RLFC
- Transistor PCB (IPM) (PARTS INFORMATION 7) \*For AOU18RLFC
- Filter PCB (Check the wire of CN110) \*For AOU18RLFC

>> **If Outdoor fan motor is abnormal, replace Outdoor unit fan motor and Main PCB.**  
 >> **If Active filter module or IPM is abnormal, replace it.**  
 >> **If the parts are normal, replace Main PCB.**

AC

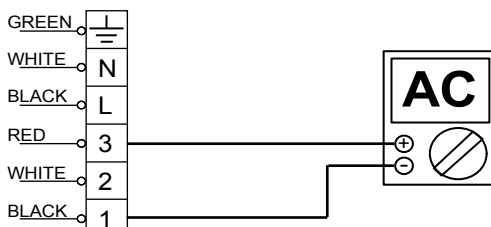

<p><b>Trouble shooting 1-2</b>  <b>INDOOR UNIT Error Method:</b>  <b>Serial communication error</b>  <b>(Serial Forward Transfer Error)</b></p>	<p><b>Indicate or Display:</b>  <b>Refer to error code table.</b></p>
---	---

<p><b>Detective Actuators:</b>  Indoor unit Controller PCB  Indoor unit Fan motor</p>	<p><b>Detective details:</b>  When the outdoor unit cannot receive the serial signal from Indoor unit more than 10seconds.</p>
---	--

**Forecast of Cause:**  
1. Connection failure    2. External cause    3. Controller PCB failure    4. Indoor unit fan motor failure

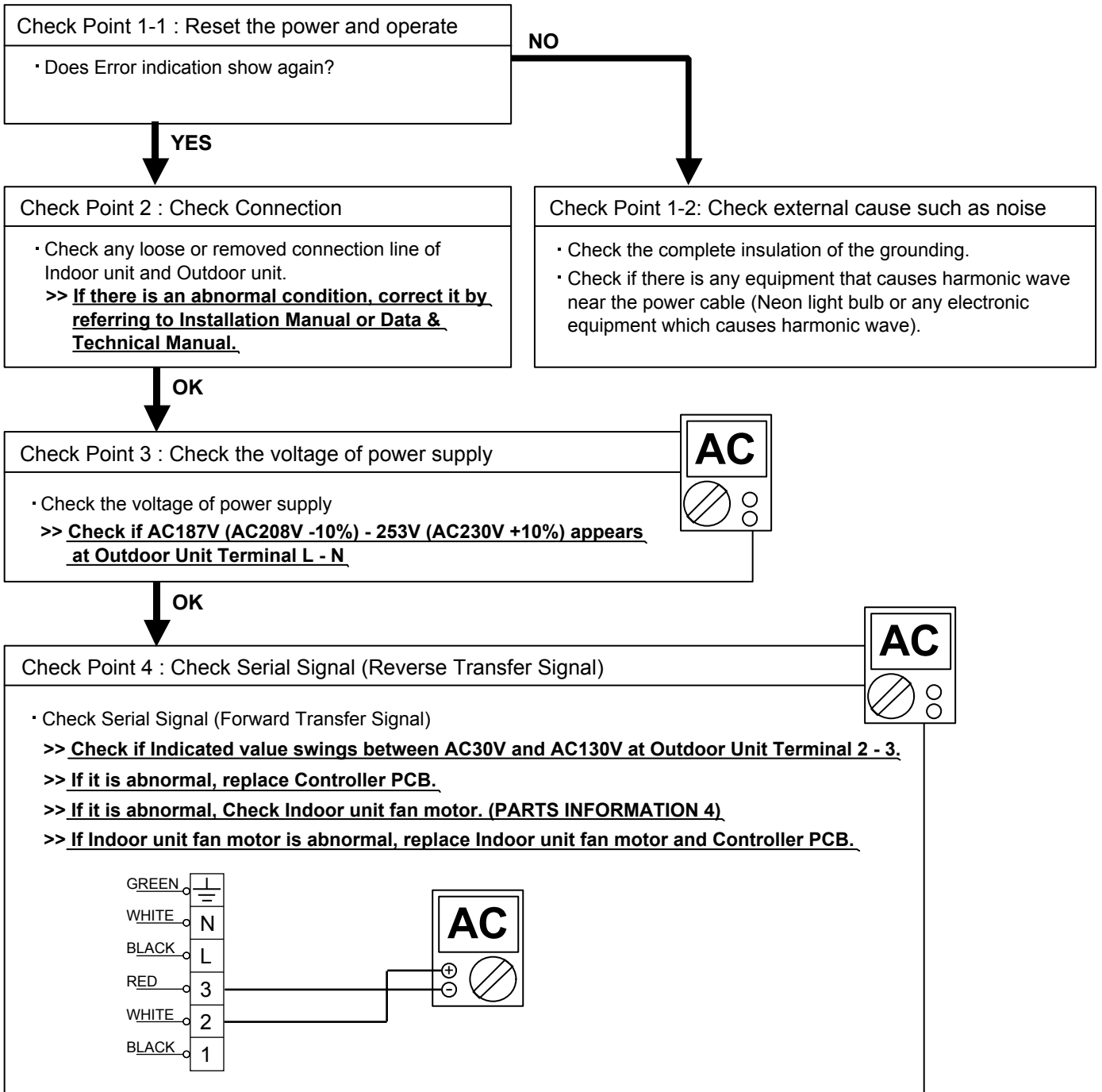

<b>Trouble shooting 2</b> <b><u>INDOOR UNIT Error Method:</u></b> <b>Wired remote controller communication error</b>	<b><u>Indicate or Display:</u></b> <b>Refer to error code table.</b>
--	---

<b><u>Detective Actuators:</u></b> Indoor unit Controller PCB Wired remote control	<b><u>Detective details:</u></b> When the indoor unit cannot receive the signal from Wired Remote Control more than 1minute during normal operation.
--	---

<b><u>Forecast of Cause:</u></b> 1. Terminal connection abnormal    2. Wired remote control failure    3. Controller PCB failure
---

<b>Check Point 1 : Check the connection of terminal</b>
<u>After turning off the power, check &amp; correct the followings.</u> · Check the connection of terminal between remote control and Indoor unit, and check if there is a disconnection of the cable.



<b>Check Point 2 : Check Remote Control and Controller PCB</b>	
· Check Voltage at CN14 (terminal 1-3) of Controller PCB. (Power supply to Remote Control)  >> If it is DC13V, Remote Control is failure. (Controller PCB is normal)                      >> Replace Remote Control >> If it is DC 0V, Controller PCB is failure. (Check Remote Control once again)              >> Replace Controller PCB  <b>▶ <u>Upon correcting the removed connector or mis-wiring, reset the power.</u></b>	

<b>Trouble shooting 3</b> <b><u>INDOOR UNIT Error Method:</u></b> <b>Indoor unit model information error</b> <b>EEPROM access abnormal</b>	<b><u>Indicate or Display:</u></b>  <b>Refer to error code table.</b>
---	---

<b><u>Detective Actuators:</u></b>  Indoor unit Controller PCB	<b><u>Detective details:</u></b> When power is on and there is some below case. 1. When model information of EEPROM is incorrect. 2. When the access to EEPROM failed.
--	---

<b><u>Forecast of Cause:</u></b> 1. External cause    2. Defective connection of electric components    3. Controller PCB failure
--

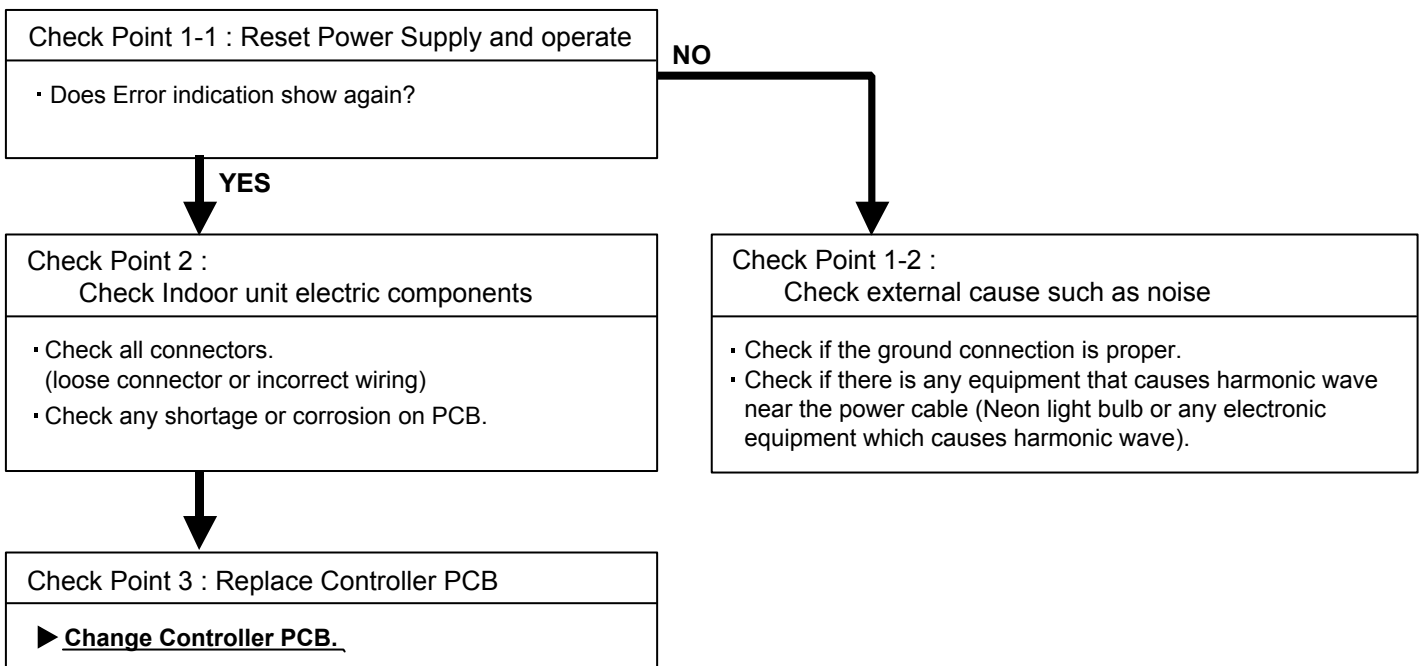

**Note : EEPROM**

EEPROM(Electronically Erasable and Programmable Read Only Memory) is a non-volatile memory which keeps memorized information even if power is turned off. It can change the contents electronically. To change the contents, it uses higher voltage than normal, and it can not change a partial contents. (Rewriting shall be done upon erasing the all contents.) There is a limit in a number of rewriting.

<p><b>Trouble shooting 4</b>  <b><u>INDOOR UNIT Error Method:</u></b>  <b>Manual auto switch error</b></p>	<p><b><u>Indicate or Display:</u></b></p> <p><b>Refer to error code table.</b></p>
--	--

<p><b><u>Detective Actuators:</u></b></p> <p>Indoor unit Controller PCB  Indicator PCB  Manual auto switch</p>	<p><b><u>Detective details:</u></b></p> <p>When the Manual Auto Switch becomes ON for consecutive 60 or more seconds.</p>
--	---

<p><b><u>Forecast of Cause :</u></b></p> <p>1. Manual auto switch failure    2.Controller PCB and Indicator PCB failure</p>
---

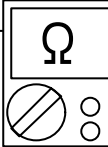
<p>Check Point 1 : Check the Manual auto switch</p> <ul style="list-style-type: none"> <li>• Check if Manual auto switch is kept pressed.</li> <li>• Check ON/OFF switching operation by using a meter.</li> </ul> <p><b>&gt;&gt;<u>If Manual Auto Switch is disabled (on/off switching), replace it.</u></b></p>	
---	--



<p>Check Point 2 : Replace Controller PCB</p> <p><b>▶ <u>If Check Point 1 do not improve the symptom, change Controller PCB and Indicator PCB.</u></b></p>
--



<b>Trouble shooting 5</b> <b>INDOOR UNIT Error Method:</b> <b>Indoor room thermistor error</b>	<b>Indicate or Display:</b>  <b>Refer to error code table.</b>
--	--

<b>Detective Actuators:</b> Indoor unit Controller PCB Room temperature thermistor	<b>Detective details:</b> When Room Temperature Thermistor open or short-circuit is detected.
--	--

**Forecast of Cause :**  
1. Connector connection failure 2. Thermistor failure 3. Controller PCB failure

**Check Point 1 : Check connection of Connector**

- Check if connector is removed.
- Check erroneous connection.
- Check if thermistor cable is open.

**>>Upon correcting the removed connector or mis-wiring, reset the power.**



**Check Point 2 : Remove connector and check Thermistor resistance value**

Thermistor Characteristics (Approx. value)

Temperature (°F)	14°F	23°F	32°F	41°F	50°F	59°F	68°F	77°F
Resistance Value (kΩ)	58.2	44.0	33.6	25.9	20.2	15.8	12.5	10.0

Temperature (°F)	86°F	95°F	104°F	113°F
Resistance Value (kΩ)	8.0	6.5	5.3	4.3

**► If Thermistor is either open or shorted, replace it and reset the power.**



**Check Point 3 : Check voltage of Controller PCB (DC5.0V)**

Make sure circuit diagram of indoor unit and check terminal voltage at Thermistor (DC5.0V)

CN5	1	1	GRAY		
	2	2	GRAY		
H/E (Pipe) Thermistor					
CN7	1	2			
Room Temp. Thermistor					
CN8	1	1	BLACK		
	2	2	BLACK		

**► If the voltage does not appear, replace Controller PCB.**

<b>Trouble shooting 6</b> <b>INDOOR UNIT Error Method:</b> <b>Indoor heat Ex.(Pipe) thermistor error</b>	<b>Indicate or Display:</b>  <b>Refer to error code table.</b>
--	--

<b>Detective Actuators:</b>  Indoor unit Controller PCB Heat Ex. temperature thermistor	<b>Detective details:</b>  When Heat Ex. Temperature Thermistor open or short-circuit is detected.
--	--

**Forecast of Cause :**  
 1. Connector connection failure   2. Thermistor failure   3. Controller PCB failure

**Check Point 1 : Check connection of Connector**

- Check if connector is removed.
- Check erroneous connection.
- Check if thermistor cable is open.

**>>Upon correcting the removed connector or mis-wiring, reset the power.**



**Check Point 2 : Remove connector and check Thermistor resistance value**

Thermistor Characteristics (Approx. value)

Temperature (°F)	14°F	23°F	32°F	41°F	50°F	68°F
Resistance Value (kΩ)	312.3	233.2	176.0	134.2	103.3	62.9

Temperature (°F)	86°F	104°F	122°F	140°F	144°F
Resistance Value (kΩ)	39.6	25.6	17.1	11.6	10.4

**► If Thermistor is either open or shorted, replace it and reset the power.**

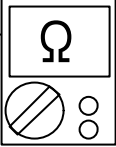

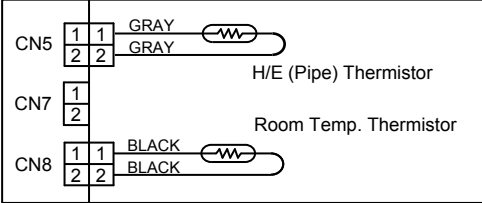

**Check Point 3 : Check voltage of Controller PCB (DC5.0V)**

Make sure circuit diagram of indoor unit and check terminal voltage at Thermistor (DC5.0V)



**► If the voltage does not appear, replace Controller PCB.**



<b>Trouble shooting 7</b> <u><b>INDOOR UNIT Error Method:</b></u> <b>Indoor unit fan motor error</b>	<u><b>Indicate or Display:</b></u> <b>Refer to error code table.</b>
--	---

<u><b>Detective Actuators:</b></u> Indoor unit Controller PCB Indoor unit Fan motor	<u><b>Detective details:</b></u> When the condition that actual frequency of Indoor Fan is below 1/3 of target frequency is continued more than 56 seconds.
---	--

<u><b>Forecast of Cause:</b></u> 1. Fan rotation failure   2. Fan motor winding open   3. Motor protection by surrounding temperature rise 4. Control PCB failure   5. Indoor unit fan motor failure
--

<b>Check Point 1 : Check rotation of Fan</b>
<ul style="list-style-type: none"> <li>· Rotate the fan by hand when operation is off. (Check if fan is caught, dropped off or locked motor)</li> <li><b>&gt;&gt;<u>If Fan or Bearing is abnormal, replace it.</u></b></li> </ul>

↓  
**OK**

<b>Check Point 2 : Check ambient temp. around motor</b>
<ul style="list-style-type: none"> <li>· Check excessively high temperature around the motor. (If there is any surrounding equipment that causes heat)</li> <li><b>&gt;&gt;<u>Upon the temperature coming down, restart operation.</u></b></li> </ul>

↓  
**OK**

<b>Check Point 3 : Check Indoor unit fan motor</b>
<ul style="list-style-type: none"> <li>· Check Indoor unit fan motor. (PARTS INFORMATION 4)</li> <li><b>&gt;&gt;<u>If Indoor unit fan motor is abnormal, replace Indoor unit fan motor.</u></b></li> </ul>

↓  
**OK**

<b>Check Point 4 : Replace Controller PCB</b>
<ul style="list-style-type: none"> <li><b>▶ <u>If Check Point 1- 3 do not improve the symptom, replace Controller PCB.</u></b></li> </ul>

<b>Trouble shooting 8</b> <b>INDOOR UNIT Error Method:</b> <b>Drain pump error</b>	<b>Indicate or Display:</b> <b>Refer to error code table.</b>
--	--

<b>Detective Actuators:</b> Indoor unit Controller PCB Float switch	<b>Detective details:</b> When Float switch is ON for more than 3 minutes.
---	---

<b>Forecast of Cause :</b> 1. Float switch failure    2. Shorted connector/wire    3. Controller PCB failure 4. Drain pump failure    5. Hose clogging
---

**Check Point 1 : Check Float switch**

- Check operation of float switch. (any blocking by dust, etc.)
- Remove Float switch and check ON/OFF switching operation by using a meter.

**>>If Float switch is abnormal, replace it.**

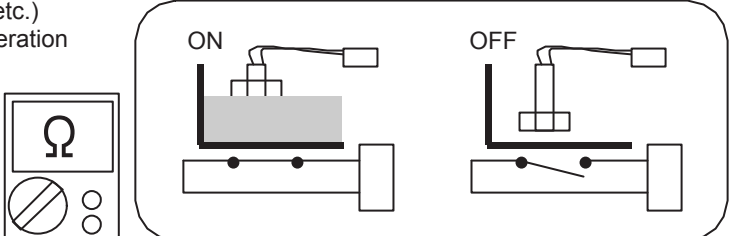

OK

**Check Point 2 : Check Connector (CN 9) / Wire**

- Check loose contact of CN9 /shorted wire (pinched wire).

**>>Replace Float switch if the wire is abnormal**

OK

**Check Point 3 : Check Drain hose**

- Check Drain hose .

**>>If there is Hose clogging. Please clear the clog.**

OK

**Check Point 4 : Check Controller PCB**

**► If Check Point 1 ~ 3 do not improve the symptom, change Controller PCB and execute the check operation again.**

<p><b>Trouble shooting 9</b>  <b><u>OUTDOOR UNIT Error Method:</u></b>  <b>Outdoor unit main PCB error</b></p>	<p><b><u>Indicate or Display:</u></b>  <b>Refer to error code table.</b></p>
--	--

<p><b><u>Detective Actuators:</u></b>  Outdoor unit Main PCB</p>	<p><b><u>Detective details:</u></b>  Access to EEPROM failed due to some cause after outdoor unit started.</p>
--	--

<p><b><u>Forecast of Cause:</u></b>  1. External cause (Noise, temporary open, voltage drop) 2. Main PCB failure</p>
--

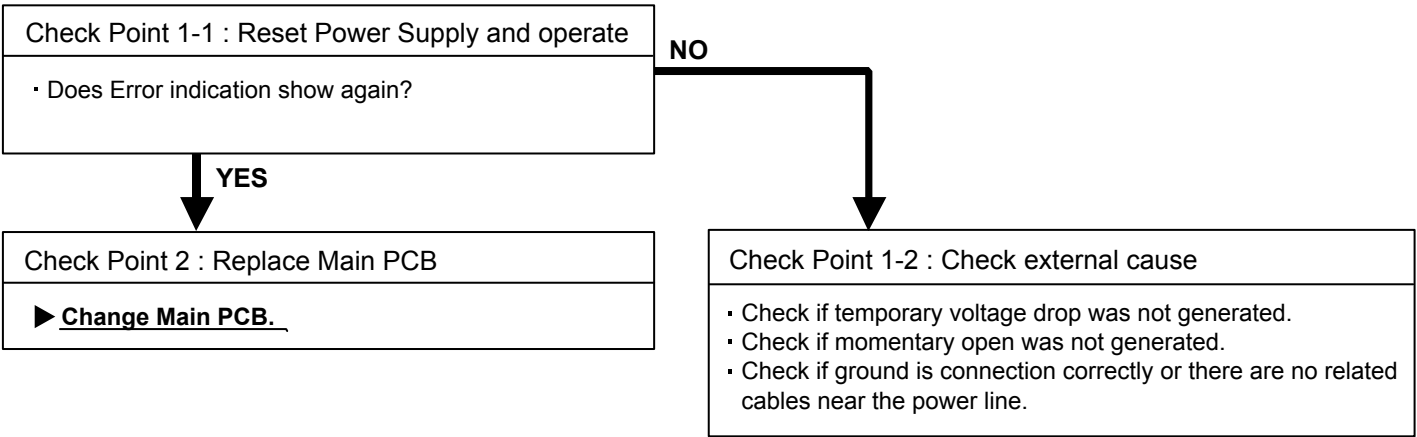

## For AOU9 / 12RLFC

<b>Trouble shooting 10-1</b> <b><u>OUTDOOR UNIT Error Method:</u></b> <b>PFC circuit error</b>	<b><u>Indicate or Display:</u></b>  <b>Refer to error code table.</b>
--	---

<b><u>Detective Actuators:</u></b>  Outdoor unit Main PCB	<b><u>Detective details:</u></b>  When inverter output DC voltage is higher than 415V for over 3 seconds, the compressor stops. If the same operation is repeated 5 times, the compressor stops permanently.
---	---

<b><u>Forecast of Cause :</u></b>  1. External cause    2. Connector connection failure    3. Main PCB failure
--

<b>Check Point 1 : Check external cause at Indoor and Outdoor (Voltage drop or Noise)</b>
<ul style="list-style-type: none"><li>• Instant drop : Check if there is a large load electric apparatus in the same circuit.</li><li>• Momentary power failure : Check if there is a defective contact or leak current in the power supply circuit.</li><li>• Noise : Check if there is any equipment causing harmonic wave near electric line. (Neon bulb or electric equipment that may cause harmonic wave) Check the complete insulation of grounding.</li></ul>



<b>Check Point 2 : Check connection of Connector</b>
<ul style="list-style-type: none"><li>• Check if connector is removed.</li><li>• Check erroneous connection.</li><li>• Check if cable is open.</li></ul> <p><b>&gt;&gt;<u>Upon correcting the removed connector or mis-wiring, reset the power.</u></b></p>



<b>Check Point 3 : Replace Main PCB</b>
<p><b>▶ <u>If Check Point 1, 2 do not improve the symptom, change Main PCB.</u></b></p>

**For AOU18RLFC**

<p><b>Trouble shooting 10-2</b>  <b><u>OUTDOOR UNIT Error Method:</u></b>  <b>Active filter error</b></p>	<p><b><u>Indicate or Display:</u></b>    <b>Refer to error code table.</b></p>
---	--

<p><b><u>Detective Actuators:</u></b>            Outdoor unit Main PCB          Active filter module</p>	<p><b><u>Detective details:</u></b>            When inverter input DC voltage is higher than 425V or lower than 80V.          When a momentary power cut off occurred on low voltage</p>
--	--

<p><b><u>Forecast of Cause :</u></b>            1. External cause    2. Connector connection failure    3. Main PCB failure    4. Active filter module failure</p>
--

<p><b>Check Point 1 : Check external cause at Indoor and Outdoor (Voltage drop or Noise)</b></p>
<ul style="list-style-type: none"> <li>▪ Instant drop : Check if there is a large load electric apparatus in the same circuit.</li> <li>▪ Momentary power failure : Check if there is a defective contact or leak current in the power supply circuit.</li> <li>▪ Noise : Check if there is any equipment causing harmonic wave near electric line. (Neon bulb or electric equipment that may cause harmonic wave)              Check the complete insulation of grounding.</li> </ul>



<p><b>Check Point 2 : Check connection of Connector</b></p>
<ul style="list-style-type: none"> <li>▪ Check if connector is removed.</li> <li>▪ Check erroneous connection.</li> <li>▪ Check if cable is open.</li> </ul> <p><b>&gt;&gt;<u>Upon correcting the removed connector or mis-wiring, reset the power.</u></b></p>



<p><b>Check Point 3 : Check Active filter module</b></p>
<ul style="list-style-type: none"> <li>▪ Check Active filter module. <b>(PARTS INFORMATION 6)</b></li> </ul> <p><b>&gt;&gt;<u>If Active filter module is abnormal, replace it.</u></b></p>



<p><b>Check Point 4 : Replace Main PCB</b></p>
<p><b>▶ <u>If Check Point 1 - 3 do not improve the symptom, change Main PCB.</u></b></p>

<b>Trouble shooting 11</b> <b>OUTDOOR UNIT Error Method:</b> <b>IPM error</b>	<b>Indicate or Display:</b>  <b>Refer to error code table.</b>
---	--

<b>Detective Actuators:</b>  Outdoor unit Main PCB Outdoor unit Transistor PCB (18RLFC) Compressor	<b>Detective details:</b>  ① When more than normal operating current to IPM in Main PCB flows, the compressor stops. ② After the compressor restarts, if the same operation is repeated within 40sec, the compressor stops again. ③ If ① and ② repeats 5 times, the compressor stops permanently.
--	---

<b>Forecast of Cause :</b>  1. Defective connection of electric components    2. Outdoor Fan Operation failure 3. Outdoor Heat Exchanger clogged                    4. Compressor failure 5. Main PCB failure    6. Transistor PCB failure (For AOU18RLFC)
--

<b>Check Point 1 : Check connections of Outdoor Unit Electrical Components</b>
<ul style="list-style-type: none"> <li>• Check if the terminal connection is loose.</li> <li>• Check if connector is removed.</li> <li>• Check erroneous connection.</li> <li>• Check if cable is open.</li> </ul> <p><b>&gt;&gt; Upon correcting the removed connector or mis-wiring, reset the power.</b></p>



<b>Check Point 2 : Check Outdoor Fan, Heat Exchanger</b>
<ul style="list-style-type: none"> <li>• Is there anything obstructing the air distribution circuit?</li> <li>• Is there any clogging of Outdoor Heat Exchanger?</li> <li>• Is the Fan rotating by hand when operation is off ?</li> </ul> <p><b>&gt;&gt; If the Fan Motor is locked, replace it.</b></p>



<b>Check Point 3 : Check Outdoor Fan</b>
<ul style="list-style-type: none"> <li>• Check Outdoor Fan Motor. (Refer to Trouble shooting 18)</li> </ul> <p><b>&gt;&gt; If the Fan Motor is failure, replace it.</b></p>



<b>Check Point 4 : Check Compressor</b>
<ul style="list-style-type: none"> <li>• Check Compressor. (PARTS INFORMATION 2)</li> </ul>



<b>Check Point 5 : Check Transistor PCB (For AOU18RLFC)</b>
<ul style="list-style-type: none"> <li>• Check Transistor PCB. (PARTS INFORMATION 7)</li> </ul>



<b>Check Point 6 : Replace Main PCB</b>
<b>► If Check Point 1 ~ 5 do not improve the symptom, change Main PCB.</b>



<b>Trouble shooting 12</b> <b>OUTDOOR UNIT Error Method:</b> <b>Discharge thermistor error</b>	<b>Indicate or Display:</b>  <b>Refer to error code table.</b>
--	--

<b>Detective Actuators:</b> Outdoor unit Main PCB Discharge pipe temperature thermistor	<b>Detective details:</b> When Discharge pipe temperature thermistor open or short-circuit is detected at power ON or while running the compressor.
---	--

**Forecast of Cause :**  
1. Connector connection failure 2. Thermistor failure 3. Main PCB failure

**Check Point 1 : Check connection of Connector**

- Check if connector is removed.
- Check erroneous connection.
- Check if thermistor cable is open.

**>>Upon correcting the removed connector or mis-wiring, reset the power.**



**Check Point 2 : Remove connector and check Thermistor resistance value**

$\Omega$

Thermistor Characteristics (Approx. value)

Temperature (°F)	14°F	23°F	32°F	41°F	50°F	68°F	86°F	104°F	122°F
Resistance Value (k $\Omega$ )	292.9	221.1	168.6	129.8	100.9	62.5	40.0	26.3	17.8

Temperature (°F)	140°F	158°F	176°F	194°F	212°F	230°F	248°F
Resistance Value (k $\Omega$ )	12.3	8.7	6.3	4.6	3.4	2.6	2.0

**► If Thermistor is either open or shorted, replace it and reset the power.**



**Check Point 3 : Check voltage of Main PCB (DC5.0V)**

**DC**

Make sure circuit diagram of outdoor unit and check terminal voltage at Thermistor (DC5.0V)

**AOU9 / 12RLFC**

**AOU18RLFC**

**► If the voltage does not appear, replace Main PCB.**

<b>Trouble shooting 13</b> <b>OUTDOOR UNIT Error Method:</b> <b>Heat Ex.(Pipe) thermistor error</b>	<b>Indicate or Display:</b>  <b>Refer to error code table.</b>
---	--

<b>Detective Actuators:</b> Outdoor unit Main PCB Heat exchanger thermistor	<b>Detective details:</b> When Heat exchanger temperature thermistor open or short-circuit is detected at power ON or while running the compressor.
---	--

**Forecast of Cause :**  
1. Connector connection failure 2. Thermistor failure 3. Main PCB failure

**Check Point 1 : Check connection of Connector**

- Check if connector is removed.
- Check erroneous connection.
- Check if thermistor cable is open.

**>>Upon correcting the removed connector or mis-wiring, reset the power.**



**Check Point 2 : Remove connector and check Thermistor resistance value**

Thermistor Characteristics (Approx. value)

Temperature (°F)	14°F	23°F	32°F	41°F	50°F	68°F	86°F	104°F	122°F
Resistance Value (kΩ)	27.8	21.0	16.1	12.4	9.6	6.0	3.8	2.5	1.7

Temperature (°F)	140°F	158°F	176°F
Resistance Value (kΩ)	1.2	0.8	0.6

► **If Thermistor is either open or shorted, replace it and reset the power.**



**Check Point 3 : Check voltage of Main PCB (DC5.0V)**

Make sure circuit diagram of outdoor unit and check terminal voltage at Thermistor (DC5.0V)

**AOU9/ 12RLFC**

THERMISTOR (PIPE)	BLACK	1	1	CN71
	BLACK	2	2	
	BROWN	3	3	
	BROWN	4	4	
THERMISTOR (DISCHARGE)				
THERMISTOR (OUTDOOR)				
BLACK	1	1	CN70	
BLACK	2	2		
BLACK	3	3		

**AOU18RLFC**

THERMISTOR (PIPE)	BLACK	1	1	CN61
	BLACK	2	2	
	BLACK	3	3	
	BLACK	4	4	
THERMISTOR (DISCHARGE)				
THERMISTOR (OUTDOOR)				
BLACK	1	1	CN62	
BLACK	2	2		
BLACK	3	3		

► **If the voltage does not appear, replace Main PCB.**

02-17

<b>Trouble shooting 14</b> <b>OUTDOOR UNIT Error Method:</b> <b>Outdoor thermistor error</b>	<b>Indicate or Display:</b>  <b>Refer to error code table.</b>
--	--

<b>Detective Actuators:</b> Outdoor unit Main PCB Outdoor thermistor	<b>Detective details:</b> When Outdoor temperature thermistor open or short-circuit is detected at power ON or while running the compressor.
--	---

**Forecast of Cause :**  
1. Connector connection failure 2. Thermistor failure 3. Main PCB failure

**Check Point 1 : Check connection of Connector**

- Check if connector is removed.
- Check erroneous connection.
- Check if thermistor cable is open.

**>>Upon correcting the removed connector or mis-wiring, reset the power.**



**Check Point 2 : Remove connector and check Thermistor resistance value**

$\Omega$

Thermistor Characteristics (Approx. value)

Temperature (°F)	-4°F	5°F	14°F	23°F	32°F	41°F	50°F	68°F	86°F
Resistance Value (k $\Omega$ )	115.2	84.2	62.3	46.6	35.2	26.9	20.7	12.6	8.0

Temperature (°F)	95°F	104°F	113°F	122°F	131°F
Resistance Value (k $\Omega$ )	6.4	5.2	4.2	3.5	2.8

**► If Thermistor is either open or shorted, replace it and reset the power.**



**Check Point 3 : Check voltage of Main PCB (DC5.0V)**

**DC**

Make sure circuit diagram of outdoor unit and check terminal voltage at Thermistor (DC5.0V)

**AOU9/ 12RLFC**

**AOU18RLFC**

**► If the voltage does not appear, replace Main PCB.**

<b>Trouble shooting 15</b> <b>OUTDOOR UNIT Error Method:</b> <b>Current sensor error</b>	<b>Indicate or Display:</b>  <b>Refer to error code table.</b>
--	--

<b>Detective Actuators:</b>  Outdoor unit Main PCB	<b>Detective details:</b> When Input Current Sensor has detected 0A, while Inverter Compressor is operating at higher than 56rps, after 1minute upon starting the Compressor. (Except during the defrost operation)
--	--

<b>Forecast of Cause :</b> 1. Defective connection of electric components    2. External cause    3. Main PCB failure
--

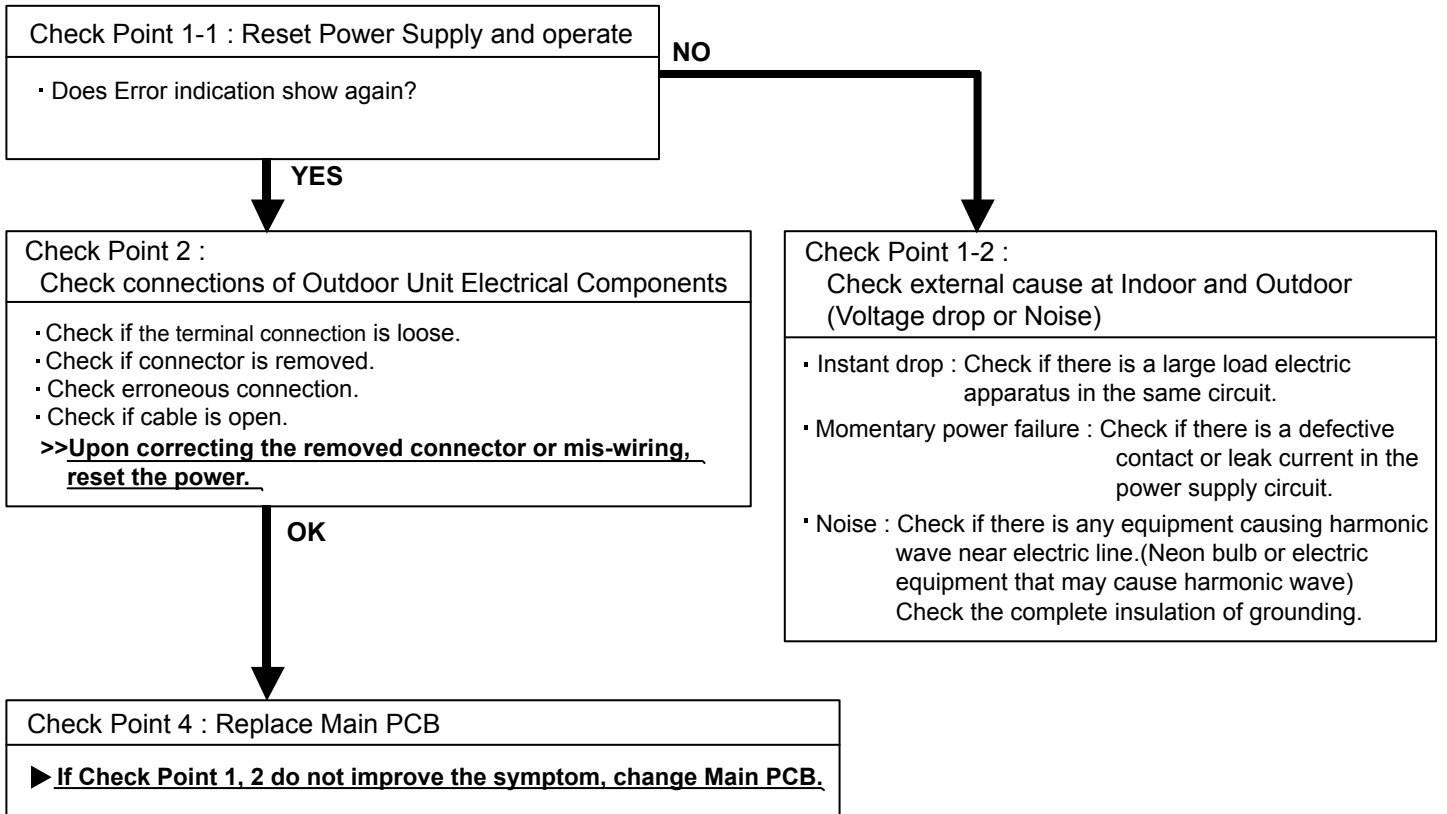

<b>Trouble shooting 16</b> <b>OUTDOOR UNIT Error Method:</b> <b>Over current error</b>	<b>Indicate or Display:</b>  <b>Refer to error code table.</b>
--	--

<b>Detective Actuators:</b>  Outdoor unit Main PCB Compressor	<b>Detective details:</b>  - " <b>Protection stop</b> by overcurrent generation after inverter compressor start processing completed" generated consecutively 10 times. * The number of generations is reset if the start-up of the compressor succeeds.
--	---

<b>Forecast of Cause :</b> <ol style="list-style-type: none"> <li>1. Outdoor unit fan operation defective, foreign matter on hear exchanger, excessive rise of ambient temperature</li> <li>2. Main PCB failure</li> <li>3. Compressor failure (lock, winding short)</li> </ol>
---

<b>Check Point 1 :</b> Check the outdoor unit fan operation, heat exchanger, ambient temperature
<ul style="list-style-type: none"> <li>• No obstructions in air passages?</li> <li>• Heat exchange fins clogged</li> <li>• Outdoor unit fan motor check</li> <li>• Ambient temperature not raised by the effect of other heat sources?</li> <li>• Discharged air not sucked in?</li> </ul>

↓ **OK**

<b>Check Point 2:</b> Replace Main PCB
▶ <b><u>If Check Point 1 do not improve the symptom, change Main PCB.</u></b>

↓ **OK**

<b>Check Point 3:</b> Replace Compressor
▶ <b><u>If Check Point 2 do not improve the symptom, change Compressor.</u></b>

<b>Trouble shooting 17</b> <b><u>OUTDOOR UNIT Error Method:</u></b> <b>Compressor control error</b>	<b><u>Indicate or Display:</u></b>  <b>Refer to error code table.</b>
---	---

<b><u>Detective Actuators:</u></b>  Outdoor unit Main PCB Compressor	<b><u>Detective details:</u></b>  ① If the detected rotor location is out of phase with actual rotor location more than 90°, the compressor stops. After the compressor restarts, if the same operation is repeated ② within 40sec, the compressor stops again. ③ If ① and ② repeats 5 times, the compressor stops permanently.
---	--

<b><u>Forecast of Cause :</u></b>  1. Defective connection of electric components    2. Main PCB failure    3. Compressor failure
---

<b>Check Point 1 : Check Noise from Compressor</b>
<ul style="list-style-type: none"> <li>• Turn on Power and check operation noise.</li> </ul> <p>▶ <b><u>If an abnormal noise show, replace Compressor.</u></b></p>



<b>Check Point 2 : Check connection of around the Compressor components</b>
For Compressor Terminal, Main PCB <ul style="list-style-type: none"> <li>• Check if connector is removed.</li> <li>• Check erroneous connection.</li> <li>• Check if cable is open.</li> </ul> (Refer to PARTS INFORMATION 2) <p>&gt;&gt;<b><u>Upon correcting the removed connector or mis-wiring, reset the power.</u></b></p>



<b>Check Point 3: Replace Main PCB</b>
<p>▶ <b><u>If Check Point 1,2 do not improve the symptom, change Main PCB.</u></b></p>



<b>Check Point 4: Replace Compressor</b>
<p>▶ <b><u>If Check Point 3 do not improve the symptom, change Compressor.</u></b></p>

<b>Trouble shooting 18</b> <b><u>OUTDOOR UNIT Error Method:</u></b>  <b>Outdoor unit fan motor error</b>	<b><u>Indicate or Display:</u></b>  <b>Refer to error code table.</b>
---	---

<b><u>Detective Actuators:</u></b>  Outdoor unit Main PCB Outdoor unit Fan motor	<b><u>Detective details:</u></b>  ① When outdoor fan rotation speed is less than 100rpm in 20 seconds after fan motor starts, fan motor stops. ② After fan motor restarts, if the same operation within 60sec is repeated 3 times in a row, compressor and fan motor stops. ③ If ① and ② repeats 5 times in a row, compressor and fan motor stops permanently.
---	--

<b><u>Forecast of Cause:</u></b>  1. Fan rotation failure    2. Motor protection by surrounding temperature rise    3. Main PCB failure 4. Outdoor unit fan motor
--

<b>Check Point 1 : Check rotation of Fan</b>
<ul style="list-style-type: none"> <li>Rotate the fan by hand when operation is off. (Check if fan is caught, dropped off or locked motor)</li> </ul> <p><b>&gt;&gt;If Fan or Bearing is abnormal, replace it.</b></p>

↓  
**OK**

<b>Check Point 2 : Check ambient temp. around motor</b>
<ul style="list-style-type: none"> <li>Check excessively high temperature around the motor. (If there is any surrounding equipment that causes heat)</li> </ul> <p><b>&gt;&gt;Upon the temperature coming down, restart operation.</b></p>

↓  
**OK**

<b>Check Point 3 : Check Outdoor unit fan motor</b>
<ul style="list-style-type: none"> <li>Check Outdoor unit fan motor. <b>(PARTS INFORMATION 5)</b></li> </ul> <p><b>&gt;&gt;If Outdoor unit fan motor is abnormal, replace Outdoor unit fan motor.</b></p>

↓  
**OK**

<b>Check Point 4 : Check Output Voltage of Main PCB</b>	<b>DC</b>																					
<ul style="list-style-type: none"> <li>Check outdoor unit circuit diagram and the voltage. (Measure at Main PCB side connector)</li> </ul>																						
<table border="1" style="width: 100%;"> <tr> <td style="width: 15%;">CN800 [9/12RLFC]</td> <td style="width: 10%;">1 RED</td> <td rowspan="7" style="text-align: center; vertical-align: middle;"> </td> </tr> <tr><td></td><td>2</td></tr> <tr><td></td><td>3 BLACK</td></tr> <tr><td></td><td>4 WHITE</td></tr> <tr><td>CN801 [18RLFC]</td><td>5 YELLOW</td></tr> <tr><td></td><td>6 BROWN</td></tr> <tr><td></td><td>7</td></tr> </table>	CN800 [9/12RLFC]	1 RED			2		3 BLACK		4 WHITE	CN801 [18RLFC]	5 YELLOW		6 BROWN		7	<table border="1" style="width: 100%;"> <thead> <tr> <th>Read wire</th> <th>DC voltage</th> </tr> </thead> <tbody> <tr> <td>Red - Black (Vm)</td> <td>240 - 400V (9/12/18RLFC)</td> </tr> <tr> <td>White - Black (Vcc)</td> <td>15 ± 1.5V</td> </tr> </tbody> </table>	Read wire	DC voltage	Red - Black (Vm)	240 - 400V (9/12/18RLFC)	White - Black (Vcc)	15 ± 1.5V
CN800 [9/12RLFC]	1 RED																					
	2																					
	3 BLACK																					
	4 WHITE																					
CN801 [18RLFC]	5 YELLOW																					
	6 BROWN																					
	7																					
Read wire	DC voltage																					
Red - Black (Vm)	240 - 400V (9/12/18RLFC)																					
White - Black (Vcc)	15 ± 1.5V																					
<b>▶ If the voltage is not correct, replace Main PCB.</b>																						

<b>Trouble shooting 19</b> <b>OUTDOOR UNIT Error Method:</b> <b>4-way valve error</b>	<b>Indicate or Display:</b>  <b>Refer to error code table.</b>
---	--

<b>Detective Actuators:</b> Indoor unit Controller PCB Heat Ex. temperature thermistor Room temperature thermistor 4-way valve Main PCB	<b>Detective details:</b> When the indoor heat exchanger temperature is compared with the room temperature, and either following condition is detected continuously two times, the compressor stops. <ul style="list-style-type: none"> <li>▪ Cooling or Dry operation [Indoor heat exchanger temp.] - [Room temp.] &gt; 20°F(10°C)</li> <li>▪ Heating operation [Indoor heat exchanger temp.] - [room temp.] &lt; - 20°F(-10°C)</li> </ul> If the same operation is repeated 5 times, the compressor stops permanently.
--	---

<b>Forecast of Cause :</b> 1. Connector connection failure   2. Thermistor failure   3. Coil failure   4. 4-way valve failure 5. Main PCB failure   6. Controller PCB failure
---

<b>Check Point 1 : Check connection of Connector</b> <ul style="list-style-type: none"> <li>▪ Check if connector is removed.</li> <li>▪ Check erroneous connection.</li> <li>▪ Check if thermistor cable is open.</li> </ul> <b>&gt;&gt; <u>Upon correcting the removed connector or mis-wiring, reset the power.</u></b>
--



<b>Check Point 2 : Check each thermistor</b> <ul style="list-style-type: none"> <li>▪ Isn't it fallen off the holder?</li> <li>▪ Is there a cable pinched?</li> </ul> <b>&gt;&gt; <u>Check characteristics of thermistor (Refer to Trouble shooting 5, 6), If defective, replace the thermistor</u></b>
--



<b>Check Point 3 : Check the solenoid coil and 4-way valve</b> [ Solenoid coil ] <ul style="list-style-type: none"> <li>▪ Remove CN30 (For 9/12RLFC) and CN500 (For 15RLFC) from PCB and check the resistance value of coil Resistance value is 1.88kΩ ~ 2.29kΩ at 68°F (20°C).</li> </ul> <b>&gt;&gt; <u>If it is Open or abnormal resistance value, replace Solenoid Coil.</u></b> [ 4-way valve ] <ul style="list-style-type: none"> <li>▪ Check each piping temperature, and the location of the valve by the temperature difference.</li> </ul> <b>&gt;&gt; <u>If the value location is not proper, replace 4-way valve.</u></b>
---



<b>Check Point 4 : Check the voltage of 4-way valve</b> <ul style="list-style-type: none"> <li>▪ Check the voltage CN30 (For 9/12RLFC) or CN500 (For 15RLFC) of Main PCB. <b>Check if AC187V(AC208V-10%) - 253V(AC230V+10%) appears at CN 30 or CN500 of Main PCB.</b></li> </ul> [ Heating operation ] <b>&gt;&gt; <u>If it is not voltage, Replace Main PCB.</u></b> [ Cooling operation ] <b>&gt;&gt; <u>If it is voltage, Replace Main PCB.</u></b>
---

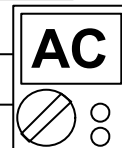

<b>Check Point 5 : Replace Controller PCB</b>  <b>▶ <u>If Check Point 1- 4 do not improve the symptom, replace Controller PCB.</u></b>
--



<b>Trouble shooting 20</b> <b>OUTDOOR UNIT Error Method:</b> <b>Discharge temperature error</b>	<b>Indicate or Display:</b>  <b>Refer to error code table.</b>
---	--

<b>Detective Actuators:</b> Outdoor unit Main PCB Discharge temperature thermistor	<b>Detective details:</b> <ul style="list-style-type: none"> <li>"Protection stop by "discharge temperature <math>\geq 230^{\circ}\text{F}(110^{\circ}\text{C})</math> during compressor operation"" generated 2 times within 24 hours.</li> </ul>
--	---

<b>Forecast of Cause :</b> <ol style="list-style-type: none"> <li>3-way valve not opened</li> <li>EEV defective, strainer clogged</li> <li>Outdoor unit operation failure, foreign matter on heat exchanger</li> <li>Discharge temperature thermistor failure</li> <li>Insufficient refrigerant</li> <li>Main PCB failure</li> </ol>
--

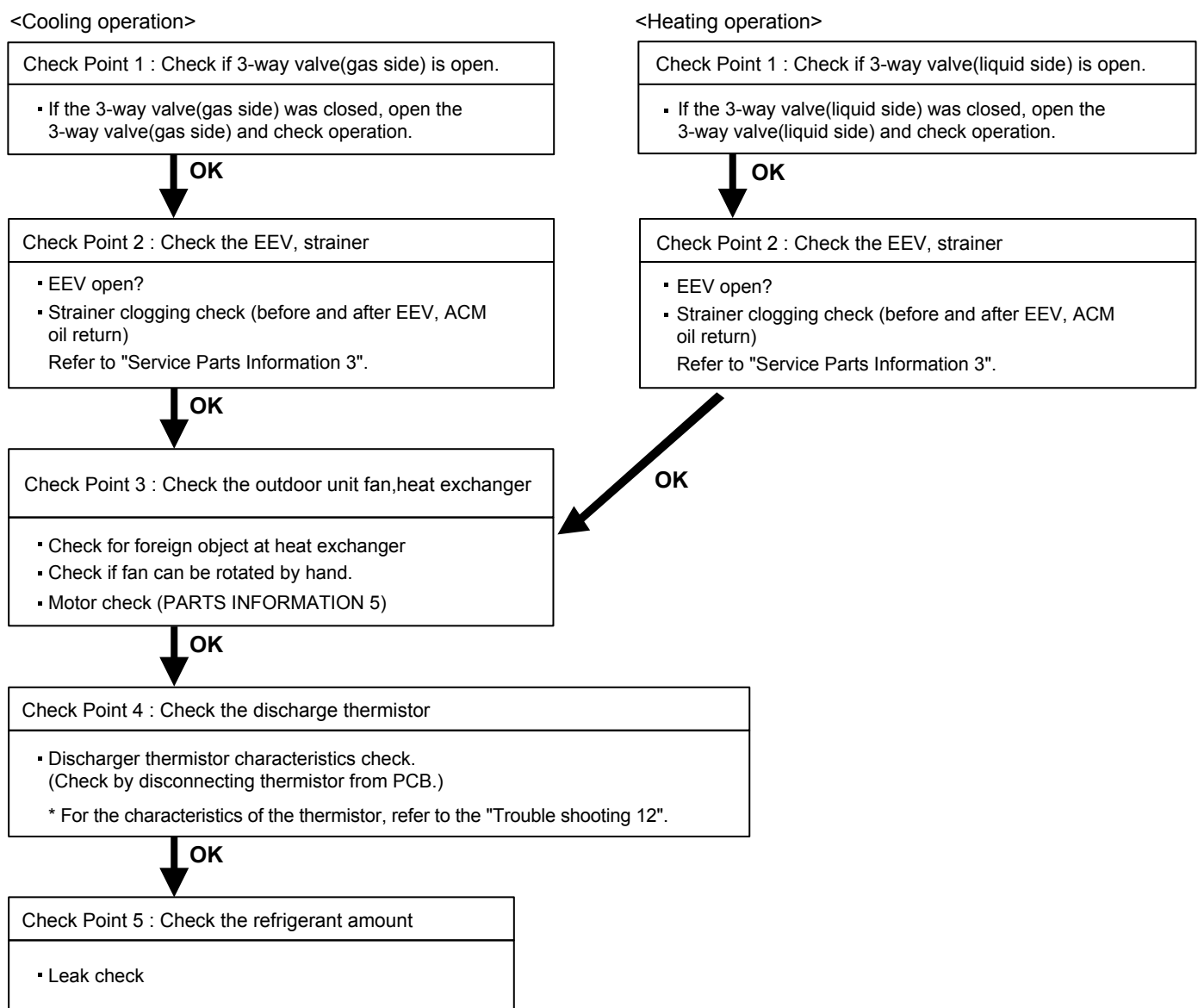

## 2-3 TROUBLE SHOOTING WITH NO ERROR CODE

### Trouble shooting 21

Indoor Unit - No Power

#### Forecast of Cause:

1. Power supply failure
2. External cause
3. Electrical components defective

#### Check Point 1 : Check Installation Condition

- Isn't the breaker down?
- Check loose or removed connection cable.
- >> **If abnormal condition is found, correct it by referring to Installation Manual or Data & Technical Manual.**

↓  
OK

#### Check Point 2 : Check external cause at Indoor and Outdoor (Voltage drop or Noise)

- Instant drop ----- Check if there is a large load electric apparatus in the same circuit.
- Momentary power failure ----- Check if there is a defective contact or leak current in the power supply circuit.
- Noise ----- Check if there is any equipment causing harmonic wave near electric line. (Neon bulb or electric equipment that may cause harmonic wave)  
Check the complete insulation of grounding.

↓  
OK

#### Check Point 3 : Check Electrical Components



- Check the voltage of power supply.
- >> **Check if AC187 - 253V appears at Outdoor Unit Terminal L - N.**

↓  
YES

- Check Fuse in Main PCB.  
>> **If Fuse is open, check if the wiring between Terminal and Main PCB is loose, and replace Fuse.**
- Check Varistor in Main PCB.  
>> **If Varistor is defective, there is a possibility of an abnormal power supply. Check the correct power supply and replace Varistor. Upon checking the normal power supply, replace Varistor.**

## Trouble shooting 22

Outdoor Unit - No Power

### Forecast of Cause:

1. Power supply failure
2. External cause
3. Electrical Components defective

#### Check Point 1 : Check Installation Condition

- Isn't the breaker down?
  - Check loose or removed connection cable.
- >>If abnormal condition is found, correct it by referring to Installation Manual or Data & Technical Manual.**

↓  
OK

#### Check Point 2 : Check external cause at Indoor and Outdoor (Voltage drop or Noise)

- Instant drop ----- Check if there is a large load electric apparatus in the same circuit.
- Momentary power failure ----- Check if there is a defective contact or leak current in the power supply circuit.
- Noise ----- Check if there is any equipment causing harmonic wave near electric line.  
(Neon bulb or electric equipment that may cause harmonic wave)  
Check the complete insulation of grounding.

↓  
OK

#### Check Point 3 : Check Electrical Components



- Check the voltage of power supply.
- >> Check if AC187 - 253V appears at Outdoor Unit Terminal L - N.**

↓  
YES

- Check Fuse in Main PCB.  
**>> If Fuse is open, check if the wiring between Terminal and Main PCB is loose, and replace Fuse.**
- Check Varistor in Main PCB.  
**>> If Varistor is defective, there is a possibility of an abnormal power supply. Check the correct power supply and replace Varistor. Upon checking the normal power supply, replace Varistor.**

↓  
OK

▶ **If the symptom does not change by above Check 3, replace Main PCB.**

### Trouble shooting 23

No Operation (Power is ON)

#### Forecast of Cause:

1. Setting/ Connection failure
2. External cause
3. Electrical component defective

#### Check Point 1 : Check indoor and outdoor installation condition

- Indoor Unit - Check incorrect wiring between Indoor Unit - Remote Control.  
Or, check if there is an open cable connection.
- Are these Indoor Unit, Outdoor Unit, and Remote Control suitable model numbers to connect?  
**>> If there is some abnormal condition, correct it by referring to Installation manual and Data & Technical Manual.**

OK

Turn off Power and check/ correct followings.

- Is there loose or removed communication line of Indoor Unit and Outdoor Unit?

OK

#### Check Point 2 : Check external cause at Indoor and Outdoor (Voltage drop or Noise)

- Instant drop ----- Check if there is a large load electric apparatus in the same circuit.
- Momentary power failure ----- Check if there is a defective contact or leak current in the power supply circuit.
- Noise ----- Check if there is any equipment causing harmonic wave near electric line.  
(Neon bulb or electric equipment that may cause harmonic wave)  
Check the complete insulation of grounding.

OK

#### Check Point 3 : Check Electrical Components at Indoor and Outdoor

- Check Voltage at CN14 (terminal 1-3) of Controller PCB.(Power supply to Remote Control)

- >> If it is DC13V, Remote Control is failure. (Controller PCB is normal) >> Replace Remote Control**
- >> If it is DC 0V, Controller PCB is failure. (Check Remote Control once again)**
  - >> Check Indoor unit fan motor. (PARTS INFORMATION 4)**
    - If it is normal, replace Controller PCB.
    - If it is abnormal, replace Indoor unit fan motor and Controller PCB.
- >> If the symptom does not change by above Check 1, 2, 3, replace Main PCB of Outdoor unit.**

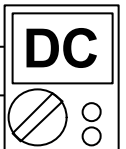

## Trouble shooting 24

No Cooling / No Heating

### Forecast of Cause:

1. Indoor Unit error
2. Outdoor Unit error
3. Effect by surrounding environment
4. Connection pipe / Connection wire failure
5. Refrigeration cycle failure

#### Check Point 1 : Check Indoor unit

- Does Indoor unit Fan run on High fan?
- Is Air filter dirty?
- Is Heat exchanger clogged?
- Check if Energy save function is operated.

↓ OK

#### Check Point 2 : Check Outdoor unit operation

- Check if Outdoor unit is operating
- Check any objects that obstruct the air flow route.
- Check clogged Heat Exchanger.
- Is the Valve open?

↓ OK

#### Check Point 3 : Check Site condition

- Is capacity of Indoor unit fitted to room size?
- Any windows open? or direct sunlight ?

↓ OK

#### Check Point 4 : Check Indoor/ Outdoor installation condition

- Check connection pipe (specified pipe length & Pipe diameter?)
- Check any loose or removed communication line.
- >> **If there is an abnormal condition, correct it by referring to Installation Manual or Data & Technical Manual.**

↓ OK

#### Check Point 5 : Check Refrigeration cycle

- Check if Strainer is clogged (Refer to the figure at right).
- Measure Gas Pressure and if there is a leakage, correct it.
- >> **When recharging the refrigerant, make sure to perform vacuuming, and recharge the specified amount.**
- Check EEV (PARTS INFORMATION 3)
- Check Compressor (PARTS INFORMATION 1,2)
- Check Heater Unit (PARTS INFORMATION 8)

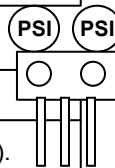

### Attention

Strainer normally does not have temperature difference between inlet and outlet as shown in ①, but if there is a difference like shown in ②, there is a possibility of inside clogged. In this case, replace Strainer.

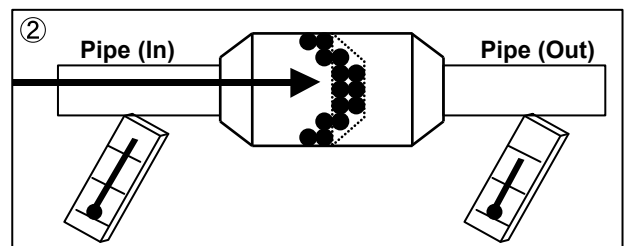
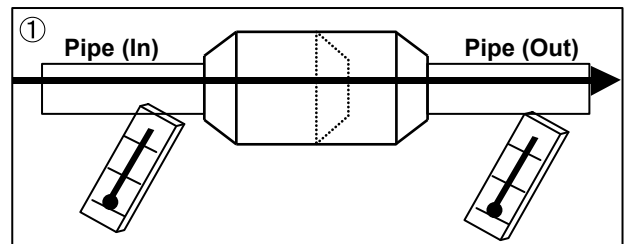

### Trouble shooting 25

#### Abnormal Noise

#### Forecast of Cause :

1. Abnormal installation (Indoor/ Outdoor)
2. Fan failure (Indoor/ Outdoor)
3. Compressor failure (Outdoor)

#### Diagnosis method when abnormal noise is occurred

- Abnormal noise is coming from Indoor unit.  
(Check and correct followings)

- Is Main unit installed in stable condition?
- Is the installation of air suction grille and front panel normal?

OK

- Is Fan broken or deformed?
- Is the screw of Fan loose?
- Is there any object which obstruct the Fan rotation?

- Abnormal noise is coming from Outdoor unit.  
(Check and correct followings)

- Is Main unit installed in stable condition?
- Is Fan guard installed normally?

OK

- Is Fan broken or deformed?
- Is the screw of Fan loose?
- Is there any object which obstruct the Fan rotation?

OK

- Check if vibration noise by loose bolt or contact noise of piping is happening.

OK

- Is Compressor locked?  
>> Check Compressor (PARTS INFORMATION 1,2)

### Trouble shooting 26

#### Water Leaking

#### Forecast of Cause:

1. Erroneous installation
2. Drain hose failure

#### Diagnosis method when water leak occurs

- Is Main unit installed in stable condition?
- Is Main unit broken or deformed at the time of transportation or maintenance?

OK

- Is Drain hose connection loose?
- Is there a trap in Drain hose?
- Is Drain hose clogged?

OK

- Is Fan rotating?

#### Diagnosis method when water is spitting out.

- Is the filter clogged?

OK

- Check Gas pressure and correct it if there was a gas leak.

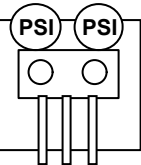

## 2-4 SERVICE PARTS INFORMATION

### SERVICE PARTS INFORMATION 1

#### Compressor

Diagnosis method of Compressor ( If Outdoor Unit LED displays Error, refer to Trouble shooting )

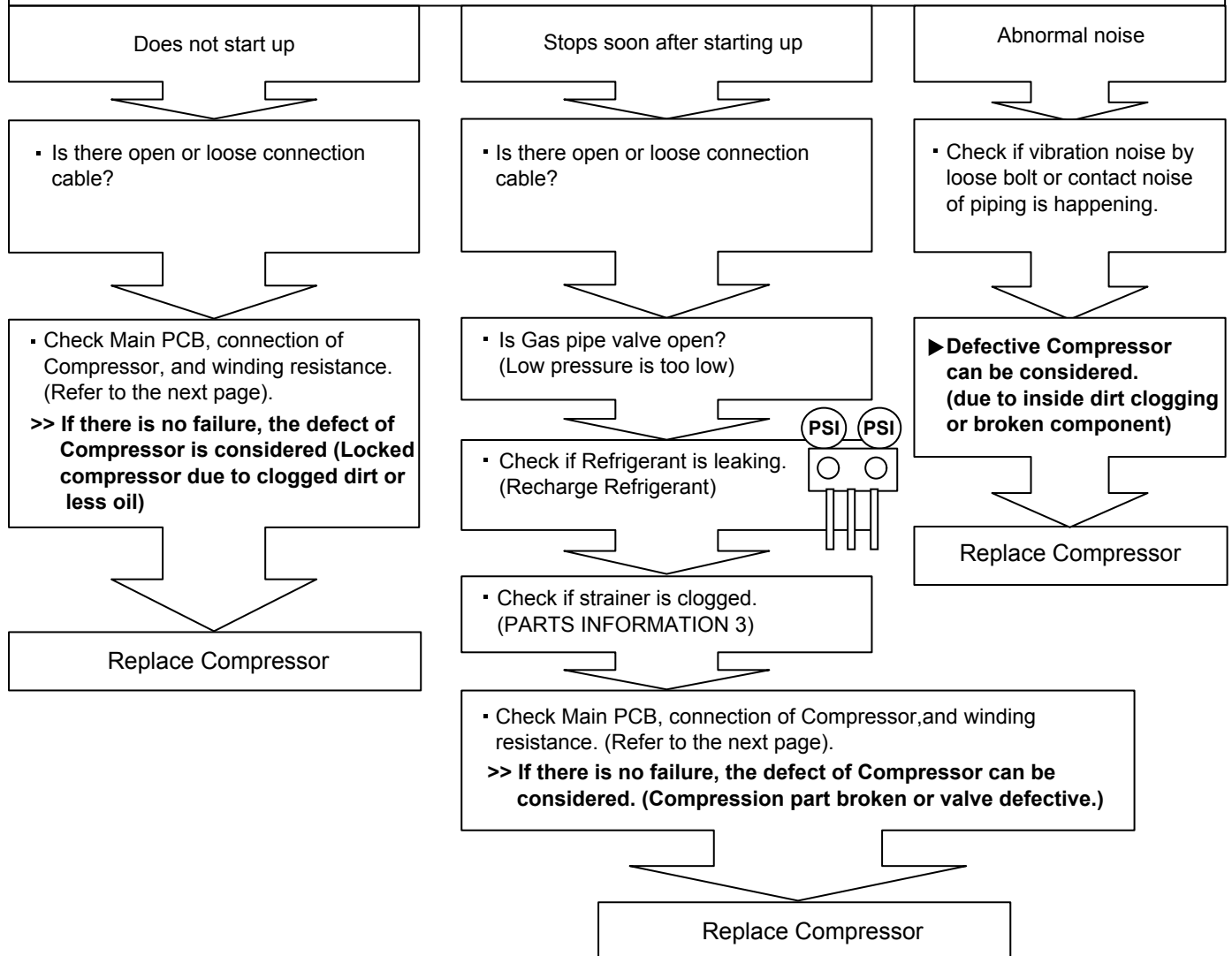

## SERVICE PARTS INFORMATION 2

### Compressor

#### Check Point 1 : Check Connection

- Check terminal connection of Compressor (loose or incorrect wiring)

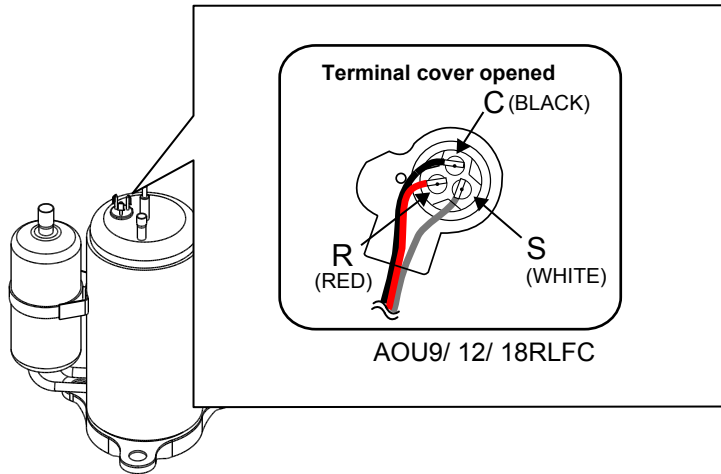

#### Check Point 2 : Check Winding Resistance

- Check winding resistance of each terminal

► **If the resistance value is 0Ω or infinite, replace Compressor.**

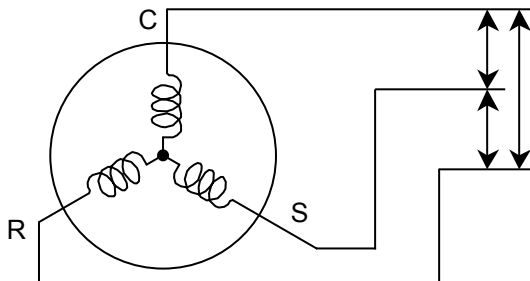

- **AOU9 / 12RLFC**  
Resistance Value :  
1.4Ω at 77°F(25°C)
- **AOU18RLFC**  
Resistance Value :  
0.7Ω at 77°F(25°C)

#### Check Point 3 : Replace Main PCB

► **If the symptom does not change with above Check 1, 2, replace Main PCB.**



### SERVICE PARTS INFORMATION 3

#### Outdoor unit Electronic Expansion Valve (EEV)

##### Check Point 1 : Check Connections

- Check connection of connector (CN40 or CN700) (Loose connector or open cable)

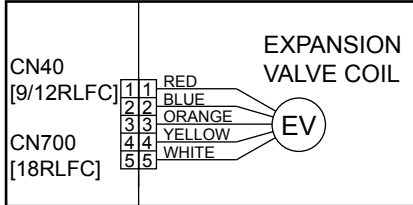

##### Check Point 2 : Check Coil of EEV

- Remove connector, check each winding resistance of Coil.

Read wire	Resistance value
White - Red	$46 \Omega \pm 4 \Omega$ at 68°F(20°C)
Yellow - Red	
Orange - Red	
Blue - Red	

► If Resistance value is abnormal, replace EEV.

##### Check Point 3 : Check Voltage from Main PCB.

- Remove Connector and check Voltage (DC12V)

► If it does not appear, replace Main PCB.



##### Check Point 4 : Check Noise at start up

- Turn on Power and check operation noise.

► If an abnormal noise does not show, replace Main PCB.

##### Check Point 5 : Check Opening and Closing Operation of Valve

When Valve is closed, it has a temp. difference between Inlet and Outlet.

**CLOSE**  
Example : Hot Gas

Pipe (In)  
Hi TEMP.

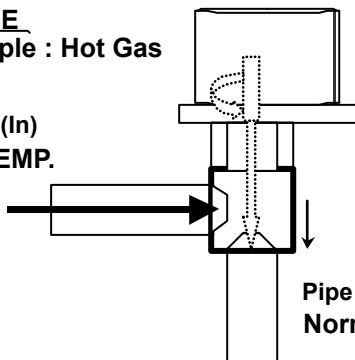

Pipe (Out)  
Normal TEMP.

If it is open, it has no temp. difference between Inlet and Outlet.

**OPEN**  
Example : Hot Gas

Pipe (In)  
Hi TEMP.

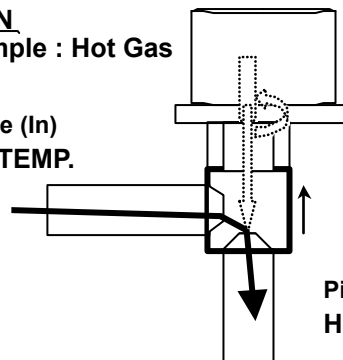

Pipe (Out)  
Hi TEMP.

##### Check Point 6 : Check Strainer

Strainer normally does not have temperature difference between inlet and outlet as shown in ①, but if there is a difference as shown in ②, there is a possibility of inside clogged. In this case, replace Strainer.

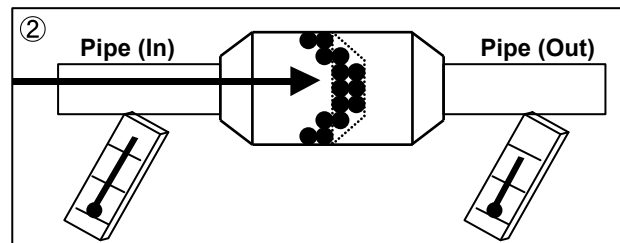
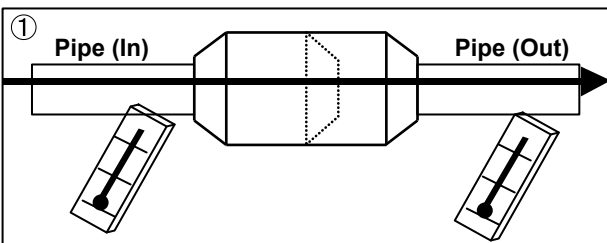

#### **SERVICE PARTS INFORMATION 4**

Indoor unit fan motor

Check Point 1 : Check rotation of Fan

- Rotate the fan by hand when operation is off.  
(Check if fan is caught, dropped off or locked motor)
- >>If Fan or Bearing is abnormal, replace it.**

Check Point 2 : Check resistance of Indoor Fan Motor

- Refer to below. Circuit-test "Vm" and "GND" terminal.  
(Vm: DC voltage, GND: Earth terminal)
- >>If they are short-circuited (below 300 k $\Omega$ ), replace Indoor fan motor and Controller PCB.**

Pin number (wire color)	Terminal function (symbol)
1 (Blue)	Feed back (FG)
2 (Yellow)	Speed command (Vsp)
3 (White)	Control voltage (Vcc)
4 (Black)	Earth terminal (GND)
5	No function
6 (Red)	DC voltage (Vm)

---

#### **SERVICE PARTS INFORMATION 5**

Outdoor unit fan motor

Check Point 1 : Check rotation of Fan

- Rotate the fan by hand when operation is off.  
(Check if fan is caught, dropped off or locked motor)
- >>If Fan or Bearing is abnormal, replace it.**

Check Point 2 : Check resistance of Outdoor Fan Motor

- Refer to below. Circuit-test "Vm" and "GND" terminal.  
(Vm: DC voltage, GND: Earth terminal)
- >>If they are short-circuited (below 300 k $\Omega$ ), replace Outdoor fan motor and Main PCB.**

Pin number (wire color)	Terminal function (symbol)
1 (Red)	DC voltage (Vm)
2	No function
3	No function
4 (Black)	Earth terminal (GND)
5 (White)	Control voltage (Vcc)
6 (Yellow)	Speed command (Vsp)
7 (Brown)	Feed back (FG)

## For AOU18RLFC

### SERVICE PARTS INFORMATION 6

Active filter module

Check Point 1 : Check Open or Short-circuit and Diode (D1)

$\Omega$

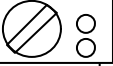

- Remove connector, check the open or short-circuit and the diode in the module

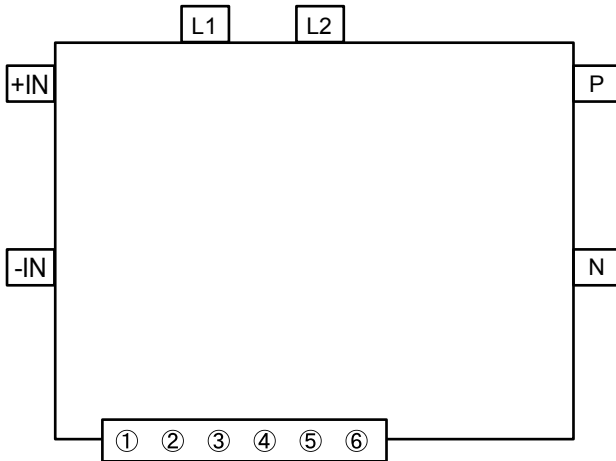

Check the open or short-circuit

Terminal		Resistance value
Tester(+)	Tester(-)	
(+IN)	(-IN)	<b>360k<math>\Omega</math> <math>\pm</math> 20%</b>
(-IN)	N	<b>0 <math>\Omega</math></b>
P	(+IN)	<b>720k<math>\Omega</math> <math>\pm</math> 20%</b>
L1	L2	<b>1.40M<math>\Omega</math> / 2.28M<math>\Omega</math></b> (Ref. value 1) (Ref. value 2)
P	N	<b>360k<math>\Omega</math> <math>\pm</math> 20%</b>
L1,L2	Control Box	<b><math>\infty</math> <math>\Omega</math></b>
L2	N	<b>1.69M<math>\Omega</math> / 1.88M<math>\Omega</math></b> (Ref. value 1) (Ref. value 2)

Check the diode

Terminal		Resistance value
Tester(+)	Tester(-)	
L2	P	<b>1.32M<math>\Omega</math> / 1.50M<math>\Omega</math></b> (Ref. value 1) (Ref. value 2)
P	L2	<b>1.40M<math>\Omega</math> / 1.51M<math>\Omega</math></b> (Ref. value 1) (Ref. value 2)

  By kind of tester, the value may change significantly.

Ref. value 1  
**Specifications for Multimeter**  
 Manufacturer : HIOKI  
 Model name : 3804  
 Power source : DC9V.

Ref. value 2  
**Specifications for Multimeter**  
 Manufacturer : YOKOGAWA  
 Model name : 7534  
 Power source : DC3V.

► If it is abnormal,replace ACTIVE FILTER MODULE

Check Point 2 : Check the Output DC voltage (between P and N)

**DC**



- Check the Output DC voltage (between P and N) of compressor stopping and operating.  
 >> If the output voltage of compressor operating is less than the output voltage of compressor stopping,  
 Active Filter Module is defective. >> Replace Active Filter Module

## For AOU18RLFC

### SERVICE PARTS INFORMATION 7

IPM

(Mounted on Transistor PCB)

#### Check Point 1

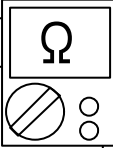

① Disconnect the connection wires between the Transistor PCB - Capacitor PCB and Transistor PCB - Inverter Compressor.

② Set the tester to the "Resistance" mode, and measure the resistance between the following terminals.

TM301 (P) - TM305(U) / TM304(V) / TM303(W)  
TM302 (N) - TM305(U) / TM304(V) / TM303(W)

③ Judge the result of ② as follows:

Terminal		Resistance value
Tester(+)	Tester(-)	
P	U	Over 2k $\Omega$ (Including $\infty\Omega$ )
P	V	
P	W	
U	P	Over 20k $\Omega$ (Including $\infty\Omega$ )
V	P	
W	P	
N	U	Over 2k $\Omega$ (Including $\infty\Omega$ )
N	V	
N	W	
U	N	Over 2k $\Omega$ (Including $\infty\Omega$ )
V	N	
W	N	

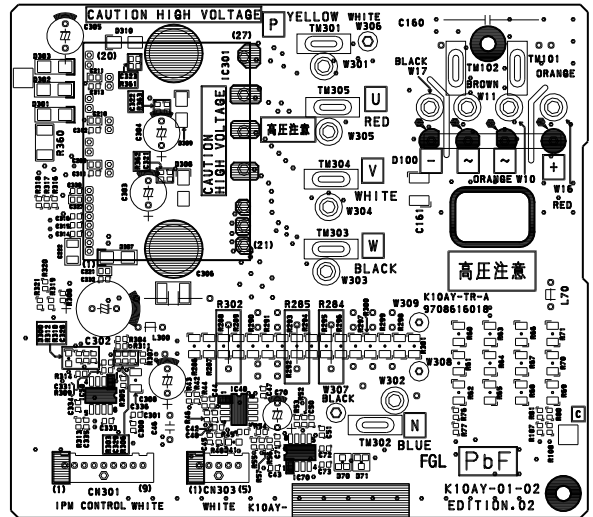

#### Check Point 2

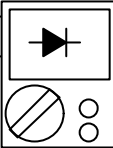

④ Set the tester to the "Diode" mode, and measure the voltage value between the following terminals.

⑤ Judge the result of ④ as follows:

Terminal		Tester display
Tester(+)	Tester(-)	
P	U	$\infty$
P	V	
P	W	
U	P	0.3V~0.7V
V	P	
W	P	
N	U	$\infty$
N	V	
N	W	
U	N	$\infty$
V	N	
W	N	

# ***SLIM DUCT type INVERTER***

## **3 . APPENDING DATA**

## 3-1. FUNCTION SETTING

### 3-1-1 INDOOR UNIT

- Follow the instructions in the Local Setup Procedure, which is supplied with the remote control, in accordance with the installed condition.  
After the power is turned on, perform the Function Setting on the remote control.
- The settings may be selected between the following two: Function Number or Setting Value.
- Settings will not be changed if invalid numbers or setting values are selected.

#### 1-1. Setting the Filter sign

The indoor unit has a sign to inform the user that it is time to clean the filter.

Select the time setting for the filter sign display interval in the table below according to the amount of dust or debris in the room.

If you do not wish the filter sign to be displayed, select the setting value for "No indication".

(◆ . . . Factory setting)

Setting Description	Function Number	Setting Value
Standard	11	00
Long interval		01
Short interval		02
◆ No indication		03

#### 1-2. Setting the Static pressure

Select appropriate static pressure according to the installation conditions.

(◆ . . . Factory setting)

Setting Description	Function Number	Setting Value
0 Pa	26	00
10 Pa		01
20 Pa		02
30 Pa		03
40 Pa		04
50 Pa		05
60 Pa		06
70 Pa		07
80 Pa		08
90 Pa		09
◆ 25 Pa [Standard]		31

### 1-3. Setting the Cooler room temperature correction

Depending on the installed environment, the room temperature sensor may require a correction. The settings may be selected as shown in the table below.

(◆ . . .Factory setting)

Setting Description	Function Number	Setting Value
◆ Standard	30	00
Slightly lower control		01
Lower control		02
Warmer control		03

When using floor console installation, change the setting value to "01".

### 1-4. Setting the Heater room temperature correction

Depending on the installed environment, the room temperature sensor may require a correction. The settings may be changed as shown in the table below.

(◆ . . .Factory setting)

Setting Description	Function Number	Setting Value
◆ Standard	31	00
Lower control		01
Slightly warmer control		02
Warmer control		03

When using floor console installation, change the setting value to "01".

### 1-5. Setting the Auto restart

Enable or disable automatic system restart after a power outage.

(◆ . . .Factory setting)

Setting Description	Function Number	Setting Value
◆ Yes	40	00
No		01

Auto restart is an emergency function such as for power failer etc.  
Do not start and stop the indoor unit by this function in normal operation.  
Be sure to operate by the control unit, or external input device.

### 1-6. Setting the Indoor room temperature sensor switching function

(Only for Wired remote controller)

The following settings are needed when use the control by Wired remote controller temperature sensor.

(◆ . . .Factory setting)

Setting Description	Function Number	Setting Value
No	42	00
Yes		01

- If setting value is "00", room temperature is controlled by the indoor unit temperature sensor.
- If setting value is "01", room temperature is controlled by either indoor unit temperature sensor or remote control unit sensor.

### 1-7. Setting the Remote controller signal code

Change the indoor unit Signal Code, depending on the remote controllers.

(◆ . . .Factory setting)

Setting Description	Function Number	Setting Value
A	44	00
B		01
C		02
D		03

### 1-8. Setting the External input control

"Operation/Stop" mode or "Forced stop" mode can be selected.

(◆ . . .Factory setting)

Setting Description	Function Number	Setting Value
Operation /Stop mode	46	00
(Setting forbidden)		01
Forced stop mode		02



## 3-1-2 PROCEDURES TO CHANGE THE FUNCTION SETTING

- The function settings of the control of the indoor unit can be changed by this procedure according to the installation conditions. Incorrect settings can cause the indoor unit malfunction.
- After the power is turned on, perform the "FUNCTION SETTING" according to the installation conditions using the remote controller.
- The settings may be selected between the following two: Function Number or Setting Value.
- Settings will not be changed if invalid numbers or setting values are selected.

### ■ PREPARATION

- Turn on the power.
  - \* By turning on the power indoor units, so make sure the piping air-tight test and vacuuming have been conducted before turning on the power.
  - \* Also check again to make sure no wiring mistakes were made before turning on the power.

### ■ FUNCTION SETTING METHOD (for Wired remote controller)

- (1) Press the SET TEMP. buttons (∨) (∧) and FAN button simultaneously for more than 5 seconds to enter the function setting mode.

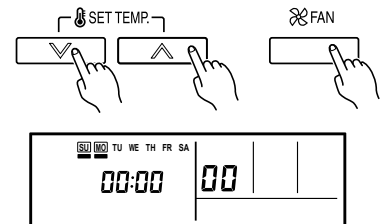

- (2) Press the SET BACK button to select the indoor unit number.

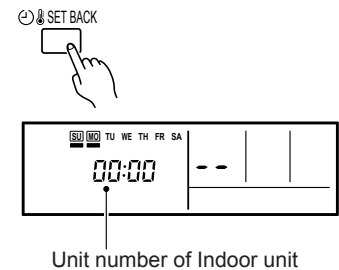

- (3) Press the Set time buttons to select the function number.

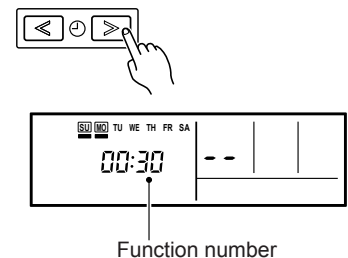

- (4) Press SET TEMP. buttons (∨) (∧) to select the setting value.  
The display flashes as shown to the right during setting value selection.

- (5) Press the TIMER SET button to confirm the setting.  
Press the TIMER SET button for a few seconds until the setting value stops flashing.  
If the setting value display changes or if "--" is displayed when the flashing stops, the setting value has not been set correctly.  
(An invalid setting value may have been selected for the indoor unit.)

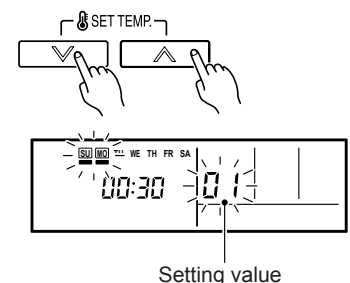

- (6) Repeat steps 2 to 5 to perform additional settings.  
Press the SET TEMP. buttons (∨) (∧) and FAN button simultaneously again for more than 5 seconds to cancel the function setting mode.  
In addition, the function setting mode will be automatically canceled after 1 minute if no operation is performed.

- (7) After completing the FUNCTION SETTING, be sure to turn off the power and turn it on again.

### ⚠ CAUTION

After turning off the power, wait 30 seconds or more before turning on it again.  
The FUNCTION SETTING doesn't become effective if it doesn't do so.

## ■ FUNCTION SETTING METHOD (for Wireless remote controller)

### Entering the Function Setting Mode

- While pressing the FAN button and SET TEMP.(▲) button simultaneously, press the RESET button to enter the function setting mode.

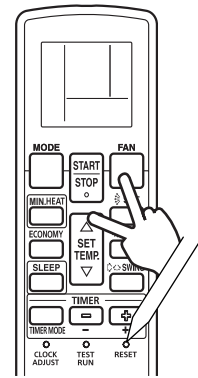

### STEP 1.

#### Setting the Remote controller Signal Code

Use the following steps to select the signal code of the remote controller.  
(Note that the air conditioner cannot receive a signal code if the air conditioner has not been set for the signal code.)

The signal code that is set through this process are applicable only to the signal in the FUNCTION SETTING.

For details on how to set the signal code through the normal process, refer to REMOTE CONTROLLER SIGNAL CODE SETTING.

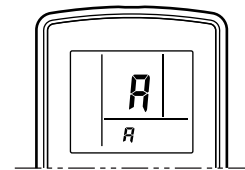

- Press the SET TEMP.(▲) (▼) button to change the signal code between  $A \rightarrow b \rightarrow c \rightarrow d$ .  
Match the code on the display to the air conditioner signal code.  
(initially set to  $A$ )  
(If the signal code does not need to be selected, press the MODE button and proceed to STEP 2.)
- Press the MODE button to accept the signal code, and proceed to STEP 2.

The air conditioner signal code is set to  $A$  prior to shipment.  
Contact your retailer to change the signal code.

The remote controller resets to signal code  $A$  when the batteries in the remote controller are replaced.  
If you use a signal code other than signal code  $A$ , reset the signal code after replacing the batteries.  
If you do not know the air conditioner signal code setting, try each of the signal codes ( $A \rightarrow b \rightarrow c \rightarrow d$ ) until you find the code which operates the air conditioner.

### STEP 2.

#### Selecting the Function Number and Setting Value

- Press the SET TEMP.(▲) (▼) buttons to select the function number.  
(Press the MODE button to switch between the left and right digits.)
- Press the FAN button to proceed to setting the value.  
(Press the FAN button again to return to the function number selection.)
- Press the SET TEMP.(▲) (▼) buttons to select the setting value.  
(Press the MODE button to switch between the left and right digits.)
- Press the TIMER MODE button, then after you hear the beep emitted from the indoor unit, press the START/STOP button to confirm the settings.
- Press the RESET button to cancel the function setting mode.
- After completing the FUNCTION SETTING, be sure to turn off the power and turn it on again.

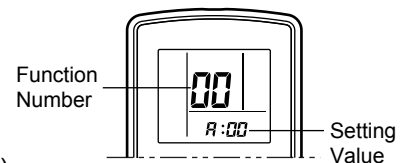

#### ⚠ CAUTION

After turning off the power, wait 10 seconds or more before turning it on again.  
The FUNCTION SETTING doesn't become effective if it doesn't do so.

## ■ REMOTE CONTROLLER SIGNAL CODE SETTING

Use the following steps to select the signal code of the remote controller.  
(Note that the air conditioner cannot receive a signal code if the air conditioner has not been set for the signal code.)

- (1) Press the START/STOP button until only the clock is displayed on the remote controller display.
- (2) Press the MODE button for at least 5 seconds to display the current signal code.  
(initially set to  $\overline{A}$ ).
- (3) Press the SET TEMP.(▲) (▼) button to change the signal code between  $\overline{A} \rightarrow \overline{B} \rightarrow \overline{C} \rightarrow \overline{D}$ .  
Match the code on the display to the air conditioner signal code.
- (4) Press the MODE button again. The signal code will be changed.

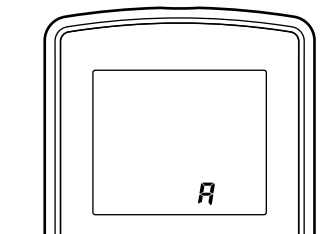

If no buttons are pressed within 30 seconds after the signal code is displayed, the display returns to the original status. In this case, start again from step 1.

The air conditioner signal code is set to  $\overline{A}$  prior to shipment.  
Contact your retailer to change the signal code.

The remote controller resets to signal code  $\overline{A}$  when the batteries in the remote controller are replaced.  
If you use a signal code other than signal code  $\overline{A}$ , reset the signal code after replacing the batteries.  
If you do not know the air conditioner signal code setting, try each of the signal codes ( $\overline{A} \rightarrow \overline{B} \rightarrow \overline{C} \rightarrow \overline{D}$ ) until you find the code which operates the air conditioner.

## 3-2. THERMISTOR RESISTANCE VALUES

### 3-2-1 INDOOR UNIT

Room temperature thermistor		
Temp (°C)	Resistance(k Ω)	Voltage(V)
-10.0	58.2	0.73
-5.0	44.0	0.93
0.0	33.6	1.15
5.0	25.9	1.39
10.0	20.2	1.66
15.0	15.8	1.94
20.0	12.5	2.22
25.0	10.0	2.50
30.0	8.0	2.77
35.0	6.5	3.03
40.0	5.3	3.27
45.0	4.3	3.48

Indoor heat exchanger thermistor		
Temp (°C)	Resistance(k Ω)	Voltage(V)
-30.0	1131.9	0.21
-25.0	804.5	0.29
-20.0	579.6	0.40
-15.0	422.9	0.53
-10.0	312.3	0.69
-5.0	233.2	0.88
0.0	176.0	1.10
5.0	134.2	1.36
10.0	103.3	1.63
15.0	80.3	1.92
20.0	62.9	2.21
25.0	49.7	2.51
30.0	39.6	2.79
35.0	31.7	3.06
40.0	25.6	3.30
45.0	20.8	3.53
50.0	17.1	3.73
55.0	14.1	3.90
60.0	11.6	4.05
63.0	10.4	4.14

### 3-2-2 OUTDOOR UNIT

Discharge thermistor Comp. temperature thermistor		
Temp (°C)	Resistance(k Ω)	Voltage(V)
-30.0	1013.1	0.06
-25.0	729.1	0.09
-20.0	531.6	0.12
-15.0	392.3	0.16
-10.0	292.9	0.21
-5.0	221.1	0.28
0.0	168.6	0.36
5.0	129.8	0.46
10.0	100.9	0.57
15.0	79.1	0.71
20.0	62.5	0.86
25.0	49.8	1.03
30.0	40.0	1.23
35.0	32.4	1.43
40.0	26.3	1.65
45.0	21.6	1.88
50.0	17.8	2.11
55.0	14.8	2.34
60.0	12.3	2.57
65.0	10.3	2.79
70.0	8.7	3.00
75.0	7.4	3.19
80.0	6.3	3.37
85.0	5.4	3.54
90.0	4.6	3.69
95.0	4.0	3.83
100.0	3.4	3.96
105.0	3.0	4.07
110.0	2.6	4.17
115.0	2.3	4.26
120.0	2.0	4.33

Outdoor heat ex.(middle) thermistor Outdoor heat ex.(outlet) thermistor		
Temp (°C)	Resistance(k Ω)	Voltage(V)
-30.0	95.6	0.24
-25.0	68.9	0.32
-20.0	50.3	0.43
-15.0	37.2	0.57
-10.0	27.8	0.73
-5.0	21.0	0.92
0.0	16.1	1.14
5.0	12.4	1.39
10.0	9.6	1.65
15.0	7.6	1.93
20.0	6.0	2.21
25.0	4.8	2.49
30.0	3.8	2.77
35.0	3.1	3.02
40.0	2.5	3.26
45.0	2.1	3.48
50.0	1.7	3.67
55.0	1.4	3.85
60.0	1.2	4.00
65.0	1.0	4.13
70.0	0.8	4.25
75.0	0.7	4.35
80.0	0.6	4.43

Outdoor temperature thermistor		
Temp (°C)	Resistance(k Ω)	Voltage(V)
-30.0	224.3	0.73
-25.0	159.7	0.97
-20.0	115.2	1.25
-15.0	84.2	1.56
-10.0	62.3	1.90
-5.0	46.6	2.26
0.0	35.2	2.61
5.0	26.9	2.94
10.0	20.7	3.24
15.0	16.1	3.52
20.0	12.6	3.76
25.0	10.0	3.96
30.0	8.0	4.14
35.0	6.4	4.28
40.0	5.2	4.40
45.0	4.2	4.50
50.0	3.5	4.59
55.0	2.8	4.65
60.0	2.4	4.71
65.0	2.0	4.76
70.0	1.6	4.79
75.0	1.4	4.83
80.0	1.2	4.85

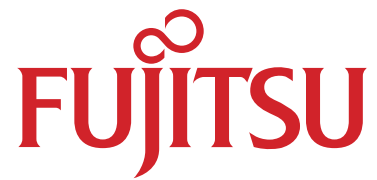

## **FUJITSU GENERAL LIMITED**

---

1116, Suenaga, Takatsu-ku, Kawasaki 213-8502, Japan