

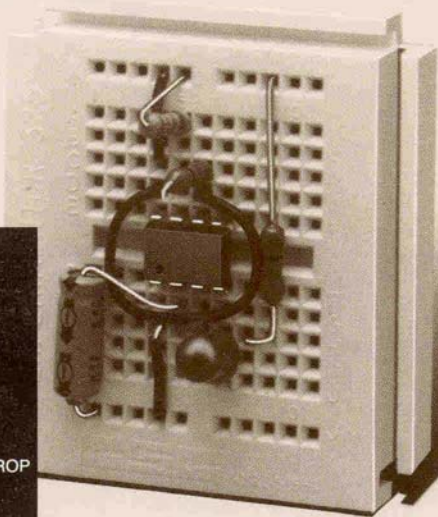

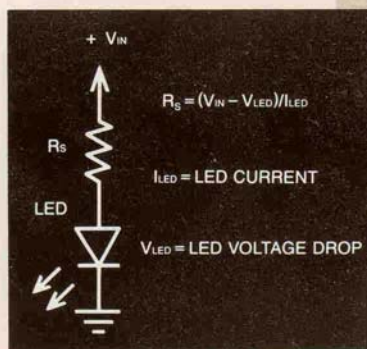









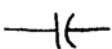
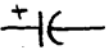
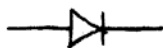



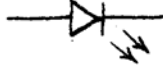
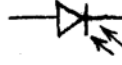

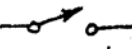
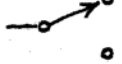
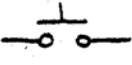
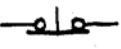

Engineer's Mini-Notebook

Formulas, Tables and
Basic Circuits

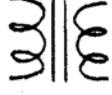

Forrest M. Mims III

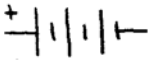
CIRCUIT SYMBOLS

			
FIXED RESISTOR	VARIABLE RESISTOR	FIXED CAPACITOR	POLARIZED CAPACITOR
			
RECTIFIER/ DIODE	ZENER DIODE	PNP TRANSISTOR	NPN TRANSISTOR
			
LED	SOLAR CELL	PHOTO-RESISTOR	PHOTO-TRANSISTOR
			
CONNECTED WIRES	UNCONNECTED WIRES	POSITIVE SUPPLY	GROUND
			
SPST SWITCH	SPDT SWITCH	NORMALLY OPEN PUSHBUTTON	NORMALLY CLOSED PUSHBUTTON
			
RELAY	TRANSFORMER	SPEAKER	PIEZO-SPEAKER
			
METER	LAMP	BATTERY	OP-AMP

ENGINEER'S
MINI-NOTEBOOK
FORMULAS, TABLES
AND BASIC CIRCUITS

BY
FORREST M. MIMS, III

SEVENTH PRINTING-1998

A SILICONCONCEPTS™ BOOK

COPYRIGHT © 1988 BY FORREST M. MIMS, III
ALL RIGHTS RESERVED

PRINTED IN THE UNITED STATES OF AMERICA

THIS BOOK INCLUDES STANDARD APPLICATION CIRCUITS AND CIRCUITS DESIGNED BY THE AUTHOR. EACH CIRCUIT WAS ASSEMBLED AND TESTED BY THE AUTHOR AS THE BOOK WAS DEVELOPED. AFTER THE BOOK WAS COMPLETED, THE AUTHOR REASSEMBLED EACH CIRCUIT TO CHECK FOR ERRORS. WHILE REASONABLE CARE WAS EXERCISED IN THE PREPARATION OF THIS BOOK, VARIATIONS IN COMPONENT TOLERANCES AND CONSTRUCTION METHODS MAY CAUSE THE RESULTS YOU OBTAIN TO DIFFER FROM THOSE GIVEN HERE. THEREFORE THE AUTHOR AND RADIO SHACK ASSUME NO RESPONSIBILITY FOR THE SUITABILITY OF THIS BOOK'S CONTENTS FOR ANY APPLICATION. SINCE WE HAVE NO CONTROL OVER THE USE TO WHICH THE INFORMATION IN THIS BOOK IS PUT, WE ASSUME NO LIABILITY FOR ANY DAMAGES RESULTING FROM ITS USE. OF COURSE IT IS YOUR RESPONSIBILITY TO DETERMINE IF COMMERCIAL USE, SALE OR MANUFACTURE OF ANY DEVICE THAT INCORPORATES INFORMATION IN THIS BOOK INFRINGES ANY PATENTS, COPYRIGHTS OR OTHER RIGHTS.

DUE TO THE MANY INQUIRIES RECEIVED BY RADIO SHACK AND THE AUTHOR, IT IS NOT POSSIBLE TO PROVIDE PERSONAL RESPONSES TO REQUESTS FOR ADDITIONAL INFORMATION (CUSTOM CIRCUIT DESIGN, TECHNICAL ADVICE, TROUBLESHOOTING ADVICE, ETC.). IF YOU WISH TO LEARN MORE ABOUT ELECTRONICS, SEE OTHER BOOKS IN THIS SERIES AND RADIO SHACK'S "GETTING STARTED IN ELECTRONICS." ALSO, READ MAGAZINES LIKE MODERN ELECTRONICS AND RADIO-ELECTRONICS. THE AUTHOR WRITES A MONTHLY COLUMN, "ELECTRONICS NOTEBOOK," FOR MODERN ELECTRONICS.

CONTENTS

1. ELECTRONIC FORMULAS	
DIRECT CURRENT	4-5
ALTERNATING CURRENT	6-7
2. MATHEMATICS	
SYMBOLS	8
POWERS OF TEN	8
ALGEBRAIC TRANSPOSITION	9
LAW OF EXPONENTS	9
COMMON LOGARITHMS	9
THE DECIBEL	10-11
NUMBER SYSTEMS (BINARY & HEX)	12-13
3. CONSTANTS AND STANDARDS	
U.S. & METRIC WEIGHTS & MEASURES	14-15
TEMPERATURE	16
COPPER WIRE; RELATIVE RESISTANCES	17
AUDIO FREQUENCY SPECTRUM	18
SOUND INTENSITY LEVELS	19
ELECTROMAGNETIC SPECTRUM	20
RADIO FREQUENCY SPECTRUM	21
FREQUENCY VS. WAVELENGTH	21
IMPORTANT FREQUENCIES	22
TIME CONVERSIONS	23
WAVES, PULSES AND SIGNALS	24-27
4. CODES AND SYMBOLS	
ALPHABET, ASCII AND MORSE CODE	28-29
GREEK ALPHABET AND SYMBOLS	30
RESISTOR COLOR CODE	31
TRANSFORMER COLOR CODE	31
5. ELECTRONIC ABBREVIATIONS	32-35
6. BASIC ELECTRONIC CIRCUITS	36-41
7. BASIC LOGIC CIRCUITS	42-45
8. POWER SUPPLIES	46-48
	3

1. ELECTRONIC FORMULAS

DIRECT CURRENT

A DIRECT CURRENT (DC) FLOWS IN ONE DIRECTION, EITHER STEADILY OR IN PULSES.

CURRENT (I) - THE QUANTITY OF ELECTRONS PASSING A GIVEN POINT.
(UNIT: AMPERE)

VOLTAGE (V) - ELECTRICAL PRESSURE OR FORCE. (UNIT: VOLT)

RESISTANCE (R) - RESISTANCE TO THE FLOW OF A CURRENT. (UNIT: OHM)

POWER (P) - THE WORK PERFORMED BY A CURRENT. (UNIT: WATT)

POTENTIAL DIFFERENCE - THE DIFFERENCE IN VOLTAGE BETWEEN THE TWO ENDS OF A CONDUCTOR THROUGH WHICH A CURRENT FLOWS. ALSO KNOWN AS VOLTAGE DROP.

OHM'S LAW

A POTENTIAL DIFFERENCE OF 1 VOLT WILL FORCE A CURRENT OF 1 AMPERE THROUGH A RESISTANCE OF 1 OHM, OR:

$$V = I \times R$$

$$I = \frac{V}{R}$$

$$R = \frac{V}{I}$$

$$P = I \times V \text{ (OR) } I^2 \times R$$

OHM'S LAW HELPER

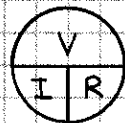

THIS DIAGRAM SHOWS THE RELATIONSHIP OF V, I AND R.

RESISTOR NETWORKS

SERIES

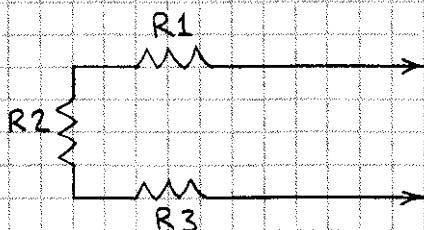

$R_T = \text{TOTAL RESISTANCE}$

$$R_T = R_1 + R_2 + R_3$$

PARALLEL (2)

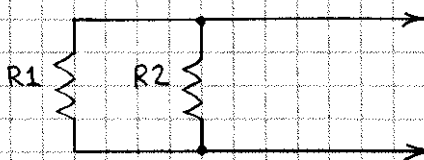

$$R_T = \frac{R_1 \times R_2}{R_1 + R_2}$$

PARALLEL (2 OR MORE)

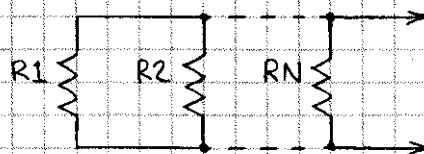

$$R_T = \frac{1}{\frac{1}{R_1} + \frac{1}{R_2} + \frac{1}{R_N}}$$

VOLTAGE DIVIDER

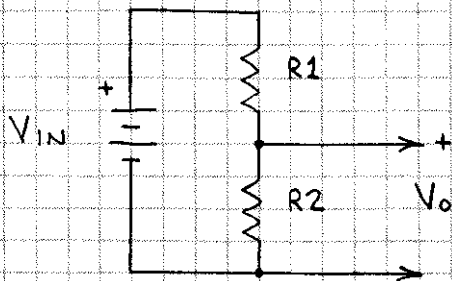

$$V_{OUT} = V_{IN} \times \left(\frac{R_2}{R_1 + R_2} \right)$$

R_1 AND R_2 CAN BE A POTENTIOMETER.

ALTERNATING CURRENT

AN ALTERNATING CURRENT (AC) FLOWS IN BOTH DIRECTIONS THROUGH A CONDUCTOR.

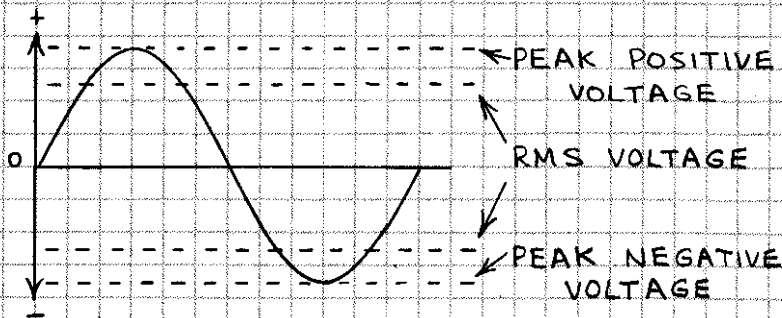

SEE THE DEFINITIONS OF I, V, R AND P ON PAGE 4.

PEAK VOLTAGE - MAXIMUM POSITIVE AND NEGATIVE EXCURSIONS OF AN ALTERNATING CURRENT.

RMS VOLTAGE - (ROOT-MEAN-SQUARE VOLTAGE) THAT AC VOLTAGE THAT EQUALS A DC VOLTAGE THAT DOES THE SAME WORK. FOR A SINE WAVE, 0.707 TIMES THE PEAK VOLTAGE.

IMPEDANCE (Z) - THE OPPOSITION TO AN ALTERNATING CURRENT PRESENTED BY A CIRCUIT.
(UNIT: OHM)

$$\begin{aligned} \text{AVERAGE AC VOLTAGE} &= 0.637 \times \text{PEAK} \\ &= 0.9 \times \text{RMS} \end{aligned}$$

$$\begin{aligned} \text{RMS AC VOLTAGE} &= 0.707 \times \text{PEAK} \\ &= 1.11 \times \text{AVERAGE} \end{aligned}$$

$$\begin{aligned} \text{PEAK AC VOLTAGE} &= 1.414 \times \text{RMS} \\ &= 1.57 \times \text{AVERAGE} \end{aligned}$$

OHM'S LAW

$$V = I \times Z$$

$$I = \frac{E}{Z}$$

$$Z = \frac{E}{I}$$

$$P = E \times I \times \cos \theta$$

θ IS PHASE ANGLE, THE DIFFERENCE IN DEGREES BETWEEN CURRENT AND VOLTAGE. CURRENT LEADS VOLTAGE IN A CAPACITIVE CIRCUIT AND LAGS VOLTAGE IN A REACTIVE CIRCUIT. IN A RESISTIVE CIRCUIT θ IS 0° . THE COSINE OF 0° IS 1. THUS IN A RESISTIVE CIRCUIT $P = E \times I$.

CAPACITOR NETWORKS

SERIES

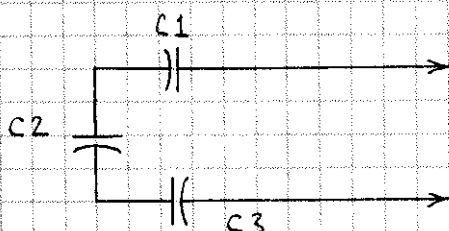

$$C_T = \frac{1}{\frac{1}{C_1} + \frac{1}{C_2} + \frac{1}{C_3}}$$

SERIES

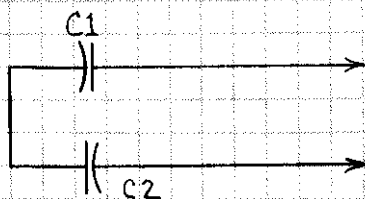

$$C_T = \frac{C_1 \times C_2}{C_1 + C_2}$$

PARALLEL (2 OR MORE)

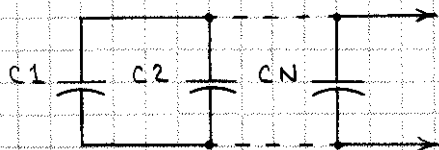

$$C_T = C_1 + C_2 + C_N$$

2. MATHEMATICS

SYMBOLS

+		PLUS, POSITIVE OR ADD
-		MINUS, NEGATIVE OR SUBTRACT
x	OR *	MULTIPLY
÷	OR /	DIVIDE
=		EQUAL(S)
≠		DOES NOT EQUAL
≈		APPROXIMATELY EQUAL
>		GREATER THAN
≥		EQUAL TO OR GREATER THAN
<		LESS THAN
≤		LESS THAN OR EQUAL TO
±		PLUS OR MINUS ; CHANGE SIGN
$\frac{1}{n}$		RECIPROCAL ($\frac{1}{2} = 0.5$)
\sqrt{n}		SQUARE ROOT OF n
$\sqrt[3]{n}$		CUBE ROOT OF n

POWERS OF TEN

10^{-9}	= 0.000000001	1 BILLIONTH (NANO)
10^{-8}	= 0.00000001	
10^{-7}	= 0.0000001	
10^{-6}	= 0.000001	1 MILLIONTH (MICRO)
10^{-5}	= 0.00001	
10^{-4}	= 0.0001	
10^{-3}	= 0.001	1 THOUSANDTH (MILLI)
10^{-2}	= 0.01	
10^{-1}	= 0.1	
10^0	= 1	1 UNIT
10^1	= 10	
10^2	= 100	
10^3	= 1,000	THOUSAND (KILO)
10^4	= 10,000	
10^5	= 100,000	
10^6	= 1,000,000	MILLION (MEGA)
10^7	= 10,000,000	
10^8	= 100,000,000	
10^9	= 1,000,000,000	BILLION (GIGA)

ALGEBRAIC TRANSPOSITION

IF $A + B = C$, THEN: IF $\frac{A}{B} = \frac{C}{D}$, THEN:

$$A = C - B$$

$$AD = BC$$

$$B = C - A$$

$$A = \frac{BC}{D}$$

$$A + B - C = 0$$

$$B = \frac{AD}{C}$$

IF $A = \frac{B}{C}$, THEN:

$$C = \frac{AD}{B}$$

$$B = AC$$

$$D = \frac{BC}{A}$$

$$C = \frac{B}{A}$$

LAW OF EXPONENTS

$$\left(\frac{a}{b}\right)^x = \frac{a^x}{b^x} \quad (a^x)(a^y) = a^{x+y}$$

$$\frac{a^x}{a^y} = a^{x-y}$$

$$(a^x)^y = a^{xy}$$

$$a^{-x} = \frac{1}{a^x}$$

$$a^{\frac{x}{y}} = \sqrt[y]{a^x}$$

COMMON LOGARITHMS

THE COMMON LOGARITHM (LOG_{10} OR LOG) OF A NUMBER IS THE POWER OF 10 THAT EQUALS THE NUMBER. SINCE $10^2 = 100$, 2 IS THE LOG OF 100. THE ANTILOGARITHM (ANTILOG) IS THE NUMBER THAT EQUALS A LOGARITHM. THUS THE ANTILOG OF 2 IS 100. THE LOG OF NUMBERS GREATER THAN 1 IS POSITIVE; THE LOG OF NUMBERS LESS THAN 1 IS NEGATIVE. THUS THE LOG OF 10^{-2} OR 0.01 IS -2. $A \times B = \text{ANTILOG}(\text{LOG} A + \text{LOG} B)$; $A \div B = \text{ANTILOG}(\text{LOG} A - \text{LOG} B)$. SCIENTIFIC CALCULATORS HAVE LOG AND ANTILOG KEYS.

THE DECIBEL

THE DECIBEL (dB) IS A UNIT OF MEASURE THAT PERMITS TWO DIFFERENT SIGNALS TO BE COMPARED ON A LOGARITHMIC SCALE. THE SENSITIVITY OF RECEIVERS AND THE GAIN OF AMPLIFIERS ARE OFTEN GIVEN IN DECIBELS. THE DIFFERENCE IN dB BETWEEN THE POWER OF A SIGNAL AT THE INPUT OF AN AMPLIFIER (P_1) AND THE POWER OF THE AMPLIFIER'S OUTPUT (P_2) IS:

$$\text{dB} = 10 \text{ LOG } (P_2/P_1)$$

THE DIFFERENCE IN dB BETWEEN THE VOLTAGE (V) AND CURRENT (I) AT THE INPUT (V_1 AND I_1) AND OUTPUT (V_2 AND I_2) OF AN AMPLIFIER IS:

$$\text{dB} = 20 \text{ LOG } (V_2/V_1)$$

$$\text{dB} = 20 \text{ LOG } (I_2/I_1)$$

NOTE THAT DECIBELS DEFINE THE RATIO BETWEEN TWO SIGNAL LEVELS, NOT THEIR ABSOLUTE VALUE.

EXAMPLE: DETERMINE THE VOLTAGE GAIN IN dB OF THIS OPERATIONAL AMPLIFIER.

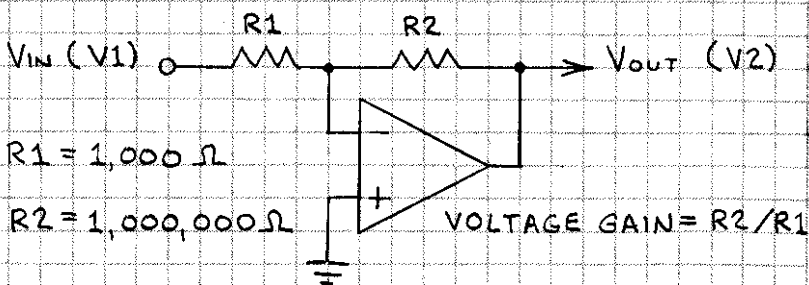

$$\text{dB} = 20 \text{ LOG } (V_2/V_1)$$

$$\text{dB} = 20 \text{ LOG } (1,000 / 1) = 20 \text{ LOG } 1000$$

LOG 1000 = 3 (FROM TABLE OR CALCULATOR)

$$\text{GAIN} = 20 \times 3 = 60 \text{ dB}$$

DECIBEL (dB) TABLE

-			+		
VOLTAGE OR CURRENT RATIO	POWER RATIO	dB	VOLTAGE OR CURRENT RATIO	POWER RATIO	
1.0000	1.0000	0	1.0000	1.0000	
.8913	.7943	1	1.1220	1.2589	
.7943	.6310	2	1.2589	1.5849	
.7079	.5012	3	1.4125	1.9953	
.6310	.3981	4	1.5849	2.5119	
.5623	.3162	5	1.7783	3.1623	
.5012	.2512	6	1.9953	3.9811	
.4467	.1995	7	2.2387	5.0119	
.3981	.1585	8	2.5119	6.3096	
.3548	.1259	9	2.8184	7.9433	
.3162	.1000	10	3.1623	10.000	
.1000	.0100	20	10.000	100.00	
.0316	.0010	30	31.623	1,000.0	
.0100	.0001	40	100.00	10,000	
.0032	.00001	50	316.23	100,000	
.0010	10^{-6}	60	1,000.0	10^6	
.0003	10^{-7}	70	3,162.3	10^7	
.0001	10^{-8}	80	10,000	10^8	
.00003	10^{-9}	90	31,623	10^9	
.00001	10^{-10}	100	100,000	10^{10}	

POWER - dBm EQUIVALENTS

RECEIVER SENSITIVITY IS OFTEN GIVEN IN dB WITH RESPECT TO 1 MILLIWATT.

dBm	POWER (mW)	UNITS
10	10.000000	10 MILLIWATTS
0	1.000000	1 MILLIWATT
-10	.100000	100 MICROWATTS
-20	.010000	10 MICROWATTS
-30	.001000	1 MICROWATT
-40	.000100	100 NANOWATTS
-50	.000010	10 NANOWATTS
-60	.000001	1 NANOWATT

NUMBER SYSTEMS

A NUMBER SYSTEM CAN BE BASED ON ANY NUMBER OF DIGITS. THE COMMON DECIMAL SYSTEM HAS 10 DIGITS. THE BINARY SYSTEM HAS 2 DIGITS; THE HEXADECIMAL SYSTEM HAS 16 DIGITS. NUMBERS ARE WRITTEN AS SUCCESSIVE POWERS OF THE BASE OF THE NUMBER SYSTEM. THUS:

$$\begin{array}{r} 4 \ 3 \ 2 \ 7_{10} \\ \begin{array}{l} \rightarrow \\ \rightarrow \\ \rightarrow \\ \rightarrow \end{array} \end{array} \begin{array}{l} 7 \times 10^0 = 7 \times 1 = 7 \\ 2 \times 10^1 = 2 \times 10 = 20 \\ 3 \times 10^2 = 3 \times 100 = 300 \\ 4 \times 10^3 = 4 \times 1000 = \underline{4000} \end{array} \begin{array}{l} = \\ = \\ = \\ = \end{array} \begin{array}{l} 7 \\ 20 \\ 300 \\ \underline{4000} \end{array} \\ 4327 \end{array}$$

BINARY NUMBERS

IN ELECTRONIC CIRCUITS DECIMAL NUMBERS ARE USUALLY REPRESENTED BY BINARY NUMBERS. BINARY NUMBERS ALSO SERVE AS CODES THAT REPRESENT LETTERS OF THE ALPHABET, VOLTAGES, COMPUTER INSTRUCTIONS, ETC. A BINARY 0 OR 1 IS A BIT. A PATTERN OF 4 BITS IS A NIBBLE. A PATTERN OF 8 BITS IS A BYTE OR WORD.

BINARY TO DECIMAL

$$\begin{array}{r} 1 \ 0 \ 0 \ 1 \ 1 \\ \begin{array}{l} \rightarrow \\ \rightarrow \\ \rightarrow \\ \rightarrow \\ \rightarrow \end{array} \end{array} \begin{array}{l} 1 \times 2^0 = 1 \\ 1 \times 2^1 = 2 \\ 0 \times 2^2 = 0 \\ 0 \times 2^3 = 0 \\ 1 \times 2^4 = \underline{16} \\ 19 \end{array}$$

DECIMAL TO BINARY

$$\begin{array}{l} 19 \div 2 = 9 + 1 \\ 9 \div 2 = 4 + 1 \\ 4 \div 2 = 2 + 0 \\ 2 \div 2 = 1 + 0 \\ \quad \quad \quad 1^* \\ 19 = 10011 \end{array}$$

* FINAL QUOTIENT IS FINAL REMAINDER

BINARY CODED DECIMAL (BCD): A SYSTEM IN WHICH EACH DECIMAL DIGIT IS ASSIGNED ITS BINARY EQUIVALENT (19 = 0001 1001).

NUMBER SYSTEM EQUIVALENTS

DEC (DECIMAL) BIN (BINARY)

BCD (BINARY CODED DECIMAL) HEX (HEXADECIMAL)

DEC	BIN	BCD	HEX
0	0	0000 0000	0
1	1	0000 0001	1
2	10	0000 0010	2
3	11	0000 0011	3
4	100	0000 0100	4
5	101	0000 0101	5
6	110	0000 0110	6
7	111	0000 0111	7
8	1000	0000 1000	8
9	1001	0000 1001	9
10	1010	0001 0000	A
11	1011	0001 0001	B
12	1100	0001 0010	C
13	1101	0001 0011	D
14	1110	0001 0100	E
15	1111	0001 0101	F
16	10000	0001 0110	10
17	10001	0001 0111	11
18	10010	0001 1000	12
19	10011	0001 1001	13
20	10100	0010 0000	14
21	10101	0010 0001	15
22	10110	0010 0010	16
23	10111	0010 0011	17
24	11000	0010 0100	18
25	11001	0010 0101	19
26	11010	0010 0110	1A
27	11011	0010 0111	1B
28	11100	0010 1000	1C
29	11101	0010 1001	1D
30	11110	0011 0000	1E
31	11111	0011 0001	1F
32	100000	0011 0010	20
64	1000000	0110 0100	40
96	1100000	1001 0110	60
99	1100011	1001 1001	63

3. CONSTANTS AND STANDARDS

U.S. WEIGHTS AND MEASURES

LINEAR

$$\begin{array}{ll} 1,000 \text{ MILS} = 1 \text{ INCH (IN)} & 3 \text{ FT} = 1 \text{ YARD (YD)} \\ 12 \text{ INCHES} = 1 \text{ FOOT (FT)} & 5,280 \text{ FT} = 1 \text{ MILE (MI)} \end{array}$$

AREA

$$\begin{array}{ll} 1 \text{ FOOT}^2 = 144 \text{ IN}^2 & 1 \text{ ACRE} = 43,560 \text{ FT}^2 \\ 1 \text{ YARD}^2 = 9 \text{ FT}^2 & 1 \text{ MILE}^2 = 640 \text{ ACRES} \end{array}$$

VOLUME

$$1 \text{ FOOT}^3 = 1,728 \text{ IN}^3 \quad 1 \text{ YARD}^3 = 27 \text{ FEET}^3$$

MASS

$$16 \text{ OUNCES (OZ)} = 1 \text{ POUND (LB)}$$

METRIC WEIGHTS AND MEASURES

LINEAR

$$\begin{array}{l} 1,000 \text{ MICROMETERS } (\mu\text{m}) = 1 \text{ MILLIMETER (mm)} \\ 10 \text{ mm} = 1 \text{ CENTIMETER (cm)} \quad 100 \text{ cm} = 1 \text{ METER (m)} \\ 1,000 \text{ METERS} = 1 \text{ KILOMETER (KM)} \end{array}$$

AREA

$$100 \text{ mm}^2 = 1 \text{ cm}^2 \quad 10,000 \text{ cm}^2 = 1 \text{ m}^2$$

VOLUME

$$1 \text{ cm}^3 = 1 \text{ MILLILITER (ml)} \quad 1,000 \text{ ml} = 1 \text{ LITER (l)}$$

MASS

$$1,000 \text{ MILLIGRAMS (mg)} = 1 \text{ gram (g)}$$

U.S. - METRIC CONVERSION

<u>TO CONVERT</u>	<u>INTO</u>	<u>MULTIPLY BY</u>
MICROMETERS	MILS	3.937×10^{-2}
MILS	MICROMETERS	25.4
MILLIMETERS	MILS	39.37
MILS	MILLIMETERS	2.54×10^{-2}
MILLIMETERS	INCHES	3.937×10^{-2}
INCHES	MILLIMETERS	25.4
CENTIMETERS	INCHES	0.3937
INCHES	CENTIMETERS	2.54
INCHES	METERS	2.54×10^{-2}
METERS	INCHES	39.37
FEET	METERS	30.48×10^{-2}
METERS	FEET	3.281
METERS	YARDS	1.094
YARDS	METERS	0.9144
KILOMETERS	FEET	3281
FEET	KILOMETERS	3.408×10^{-4}
KILOMETERS	MILES	0.6214
MILES	KILOMETERS	1.609
GRAMS	OUNCES	3.527×10^{-2}
OUNCES	GRAMS	28.3495
KILOGRAMS	POUNDS	2.205
POUNDS	KILOGRAMS	0.4536

FAMILIAR EXAMPLES

DIMENSIONS

DIME $\approx 1 \text{ mm} \times 1.8 \text{ cm}$

NICKEL $\approx 2 \text{ mm} \times 2.1 \text{ cm}$

QUARTER $\approx 2 \text{ mm} \times 2.4 \text{ cm}$

1-MIL PLASTIC FILM = $25.4 \mu\text{m}$

MASS

PLASTIC TO-92 TRANSISTOR $\approx 0.25 \text{ g}$

8-PIN MINI DIP IC $\approx 0.5 \text{ g}$

16-PIN DIP IC $\approx 1.05 \text{ g}$

NICKEL $\approx 5 \text{ g}$

TEMPERATURE

$$^{\circ}\text{FAHRENHEIT} = (^{\circ}\text{CELSIUS} \times \frac{9}{5}) + 32 = ^{\circ}\text{F}$$

$$^{\circ}\text{CELSIUS} = \frac{5}{9} \times (^{\circ}\text{FAHRENHEIT} - 32) = ^{\circ}\text{C}$$

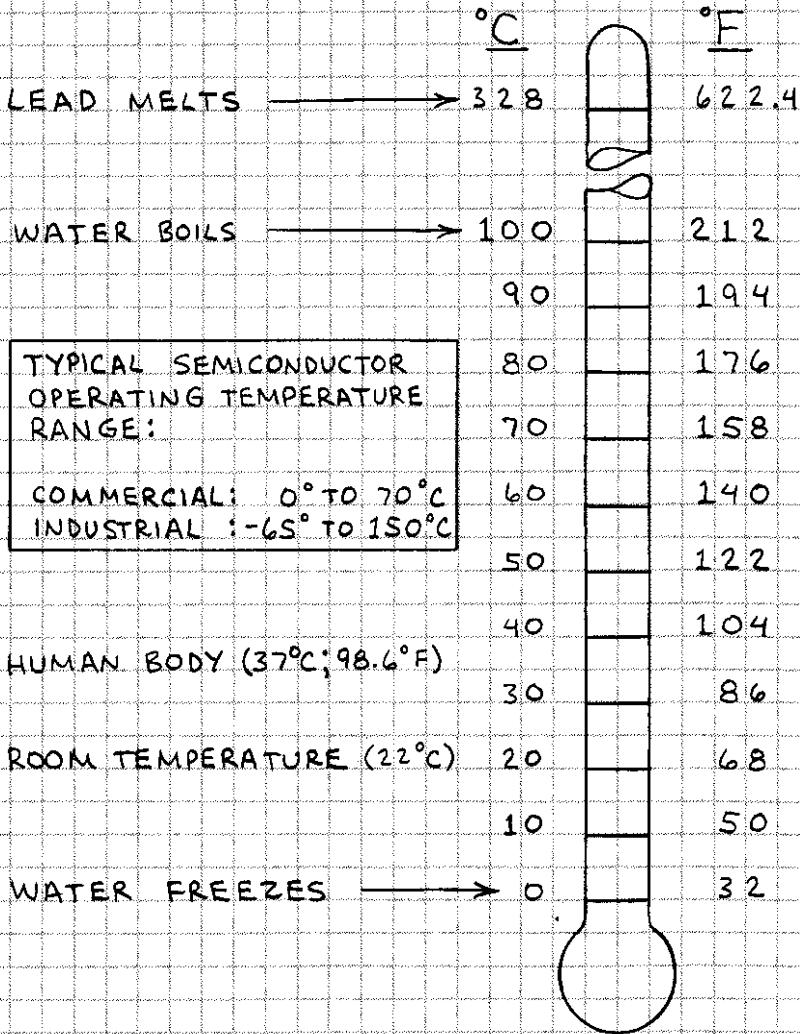

SOLDER

THE MOST COMMON ELECTRONIC SOLDER IS 60/40 (60% TIN AND 40% LEAD). ITS MELTING POINT IS 183 $^{\circ}$ TO 190 $^{\circ}$ C (361 $^{\circ}$ TO 374 $^{\circ}$ F).

COPPER WIRE

AWG	DIA	OHMS PER 1000 FT	FT PER POUND
10	101.9	99.89	31.82
12	80.8	1.588	50.59
14	64.1	2.525	80.44
16	50.8	4.016	127.9
18	40.3	6.385	203.4
20	32.0	10.15	323.4
22	25.4	16.14	514.2
24	20.1	25.67	817.7
26	15.9	40.81	1300.0
28	12.6	64.90	2067.0
30	10.0	103.2	3287.0
32	7.9	164.1	5227.0
34	6.3	260.9	8310.0
36	5.0	414.8	13210.0
38	4.0	659.6	21010.0
40	3.1	1,049.0	33,410.0

AWG - AMERICAN WIRE GAUGE

DIA - DIAMETER IN MILS

OHMS PER 1000 FT - 20°C (68°F)

RELATIVE RESISTANCES

SILVER	0.936	RESISTANCE
COPPER	1.000	RELATIVE TO
GOLD	1.403	COPPER. 1 FOOT OF
CHROMIUM	1.530	CIRCULAR COPPER
ALUMINUM	1.549	WIRE 1 MIL IN
TUNGSTEN	3.203	DIAMETER HAS A
BRASS	4.822	RESISTANCE OF
PHOSPHOR-BRONZE	5.533	10.37 OHMS.
NICKEL	5.786	ALTERNATIVELY,
IRON	5.799	COPPER WIRE HAS
TIN	6.702	A RESISTANCE
STEEL	9.932	OF 10.37 OHMS
LEAD	12.922	PER CIRCULAR
STAINLESS STEEL	52.941	MIL FOOT.
NICHROME	65.092	

AUDIO FREQUENCY SPECTRUM

MECHANICAL VIBRATION IN SOLIDS, FLUIDS AND GASES PRODUCES WHAT THE BRAIN PERCEIVES AS SOUND.

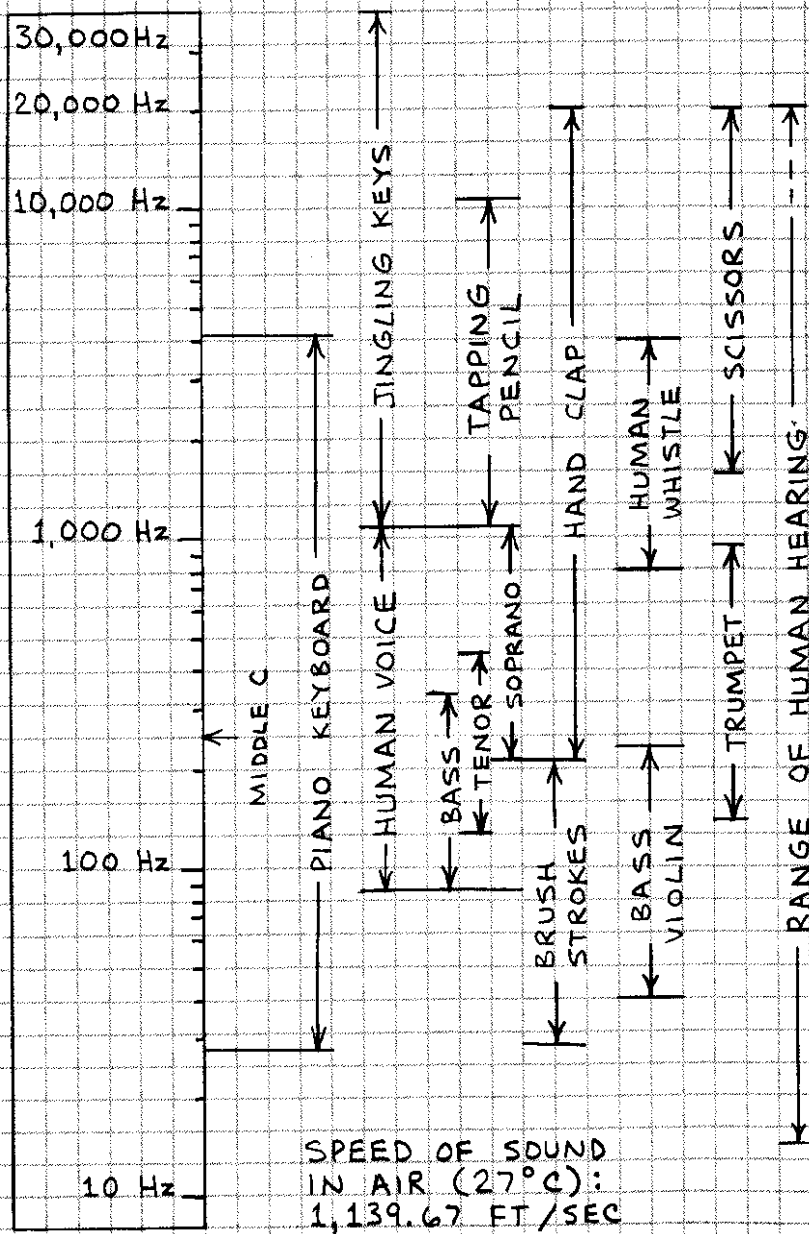

SPEED OF SOUND
IN AIR (27°C):
1,139.67 FT/SEC

SOUND INTENSITY LEVELS

SOUND SOURCE (DISTANCE FROM OBSERVER)	LEVEL (dB)
THRESHOLD OF PAIN	120+
AIRCRAFT ENGINE (20')	120+
AMPLIFIED ROCK MUSIC	110
THUNDER	110
PIEZOELECTRIC BUZZER (12")	108
AIR FORCE T-38 (2,500' OVERHEAD)	90
CO ₂ PELLET GUN (12")	90
DIGITAL ALARM CLOCK (12")	85
ELECTRIC TYPEWRITER (18")	80
AIR FORCE T-38 (1 MILE)	70
TYPICAL CONVERSATION	65
PAPER CLIP DROPPED ON DESK (12")	62
TELEPHONE DIAL TONE (1")	56
PENCIL ERASER TAPPED ON DESK (12")	54
COMPUTER KEYBOARD (18")	61
AVERAGE RESIDENCE	45
SOFT BACKGROUND MUSIC	30
QUIET WHISPER	20
THRESHOLD OF HEARING	0

ELECTROMAGNETIC SPECTRUM

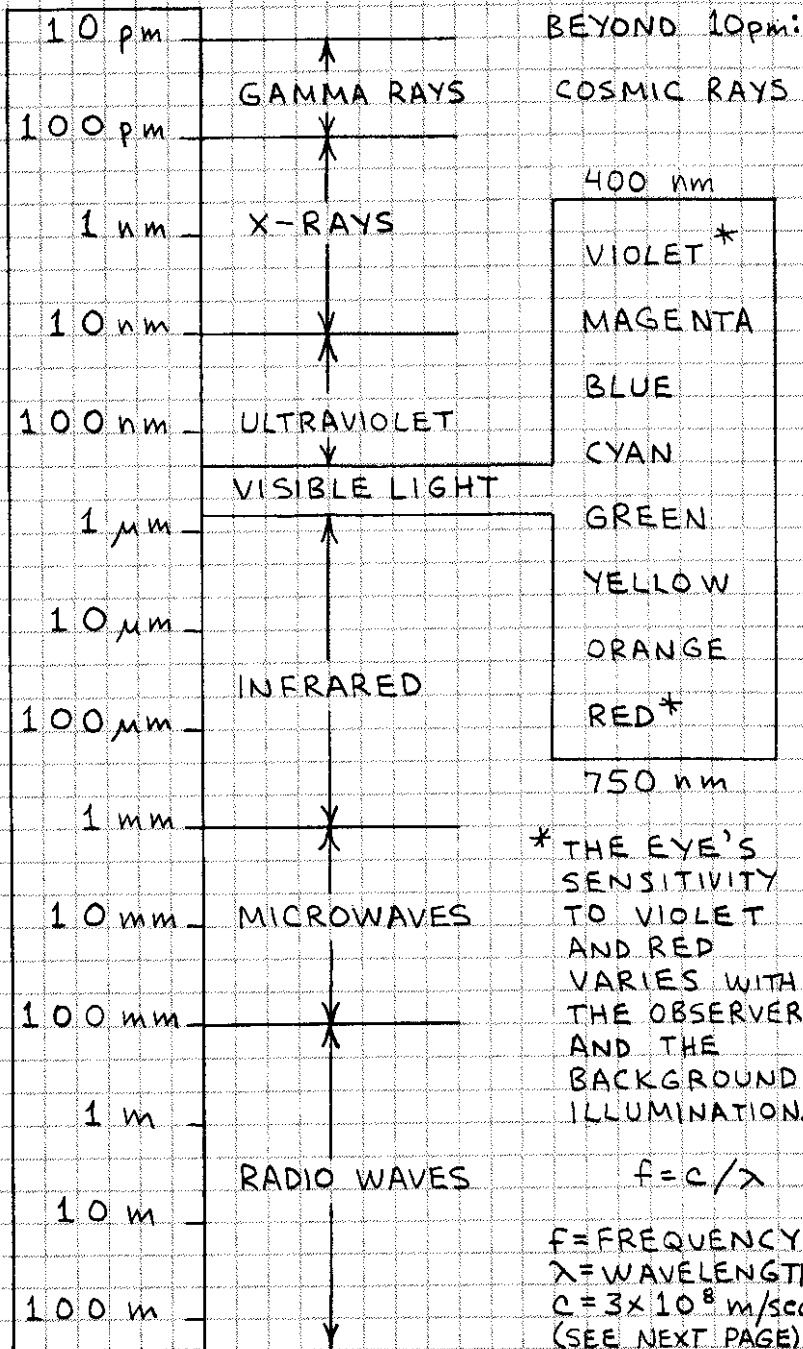

RADIO FREQUENCY SPECTRUM

FREQUENCY	CLASSIFICATION
3-30 KHz	VERY LOW FREQUENCIES (VLF)
30-300 KHz	LOW FREQUENCIES (LF)
300-3000 KHz	MEDIUM FREQUENCIES (MF)
3-30 MHz	HIGH FREQUENCIES (HF)
30-300 MHz	VERY HIGH FREQUENCIES (VHF)
300-3000 MHz	ULTRA HIGH FREQUENCIES (UHF)
3-30 GHz	SUPER HIGH FREQUENCIES (SHF)
30-300 GHz	EXTREMELY HIGH FREQUENCIES (EHF)
300-3000 GHz	MICROWAVE FREQUENCIES

FREQUENCY VS. WAVELENGTH

$$\lambda = \frac{c}{f}$$

$$f = \frac{c}{\lambda}$$

λ - WAVELENGTH (METERS)

c - SPEED OF LIGHT (3×10^8 METERS/SEC)

f - FREQUENCY (HERTZ)

EXAMPLE: THE WAVELENGTH OF A 108 MHz SIGNAL IS $3 \times 10^8 / 1.08 \times 10^6$ OR 2.78 METERS.

IMPORTANT FREQUENCIES (MHz)

- .15 - .54: NAVIGATION BEACONS
- .5 : INTERNATIONAL DISTRESS
- .54 - 1.6: AM BROADCAST BAND
- 1.61: AIRPORT INFORMATION
- 1.8 - 2.0: 160 METER AMATEUR BAND
- 2.3 - 2.498: 120 METER INT. BROADCAST
- 2.5: WWV TIME SIGNAL
- 3.5 - 4.0: 80 METER AMATEUR BAND
- 5.0: WWV TIME SIGNAL
- 5.95 - 6.2: 49 METER INT. BROADCAST
- 6.2 - 6.525: MARITIME COMMUNICATIONS
- 7.0 - 7.3: 40 METER AMATEUR
- 7.0 - 7.3: 40 METER INT. BROADCAST
- 9.5 - 9.9: 31 METER INT. BROADCAST
- 10.0: WWV TIME SIGNAL
- 10.1 - 10.15: 30 METER AMATEUR BAND
- 10.15 - 11.175: INT. BROADCAST
- 11.7 - 11.975: 25 METER INT. BROADCAST
- 14.0 - 14.35: 20 METER AMATEUR BAND
- 15.0: WWV TIME SIGNAL
- 20.0: WWV TIME SIGNAL
- 21.0 - 21.45: 15 METER AMATEUR BAND
- 21.45 - 21.85: 13 METER INT. BROADCAST
- 24.89 - 24.99: 12 METER AMATEUR BAND
- 25.67 - 26.1: 11 METER INT. BROADCAST
- 26.9 - 27.4: CITIZENS BAND
- 28.0 - 29.7: 10 METER AMATEUR BAND
- 49.82 - 49.9: LOW POWER COMMUNICATIONS
- 50.0 - 54.0: 6 METER AMATEUR BAND
- 54.0 - 88.0: TELEVISION (CH. 2-6)
- 72.03 - 72.9: RADIO CONTROL (AIRCRAFT ONLY)
- 75.43 - 75.87: RADIO CONTROL
- 88.0 - 108.0: FM BROADCAST BAND
- 88.0 - 108.0: WIRELESS MICROPHONES
- 108.0 - 118.0: AIR NAVIGATION BEACONS
- 118.0 - 136.0: AIRCRAFT
- 153 - 155: POLICE, FIRE, MUNICIPAL
- 158 - 159: POLICE, FIRE, MUNICIPAL
- 162.4 - 162.55: NOAA WEATHER
- 174 - 216: TELEVISION (CH. 7-13)
- 470 - 890: TELEVISION (CH. 14-83)

TIME CONVERSIONS

UTC	PST	MST	CST	EST	AST
0000	4 PM	5 PM	6 PM	7 PM	8 PM
0100	5 PM	6 PM	7 PM	8 PM	9 PM
0200	6 PM	7 PM	8 PM	9 PM	10 PM
0300	7 PM	8 PM	9 PM	10 PM	11 PM
0400	8 PM	9 PM	10 PM	11 PM	MIDNT
0500	9 PM	10 PM	11 PM	MIDNT	1 AM
0600	10 PM	11 PM	MIDNT	1 AM	2 AM
0700	11 PM	MIDNT	1 AM	2 AM	3 AM
0800	MIDNT	1 AM	2 AM	3 AM	4 AM
0900	1 AM	2 AM	3 AM	4 AM	5 AM
1000	2 AM	3 AM	4 AM	5 AM	6 AM
1100	3 AM	4 AM	5 AM	6 AM	7 AM
1200	4 AM	5 AM	6 AM	7 AM	8 AM
1300	5 AM	6 AM	7 AM	8 AM	9 AM
1400	6 AM	7 AM	8 AM	9 AM	10 AM
1500	7 AM	8 AM	9 AM	10 AM	11 AM
1600	8 AM	9 AM	10 AM	11 AM	12 AM
1700	9 AM	10 AM	11 AM	12 AM	1 PM
1800	10 AM	11 AM	12 AM	1 PM	2 PM
1900	11 AM	12 AM	1 PM	2 PM	3 PM
2000	12 AM	1 PM	2 PM	3 PM	4 PM
2100	1 PM	2 PM	3 PM	4 PM	5 PM
2200	2 PM	3 PM	4 PM	5 PM	6 PM
2300	3 PM	4 PM	5 PM	6 PM	7 PM

UTC - COORDINATED UNIVERSAL TIME
(GREENWICH MERIDIAN TIME, LONDON)

PST - PACIFIC STANDARD TIME

MST - MOUNTAIN STANDARD TIME

CST - CENTRAL STANDARD TIME

EST - EASTERN STANDARD TIME

AST - ATLANTIC STANDARD TIME

DAYLIGHT SAVINGS TIME - ADD 1 HOUR

THE SINE WAVE

THE SINE OR SINUSOIDAL WAVE IS THE MOST COMMON PERIODIC WAVE IN ANALOG ELECTRONIC CIRCUITS. IF PEAK AMPLITUDES ARE +1 AND -1, THEN:

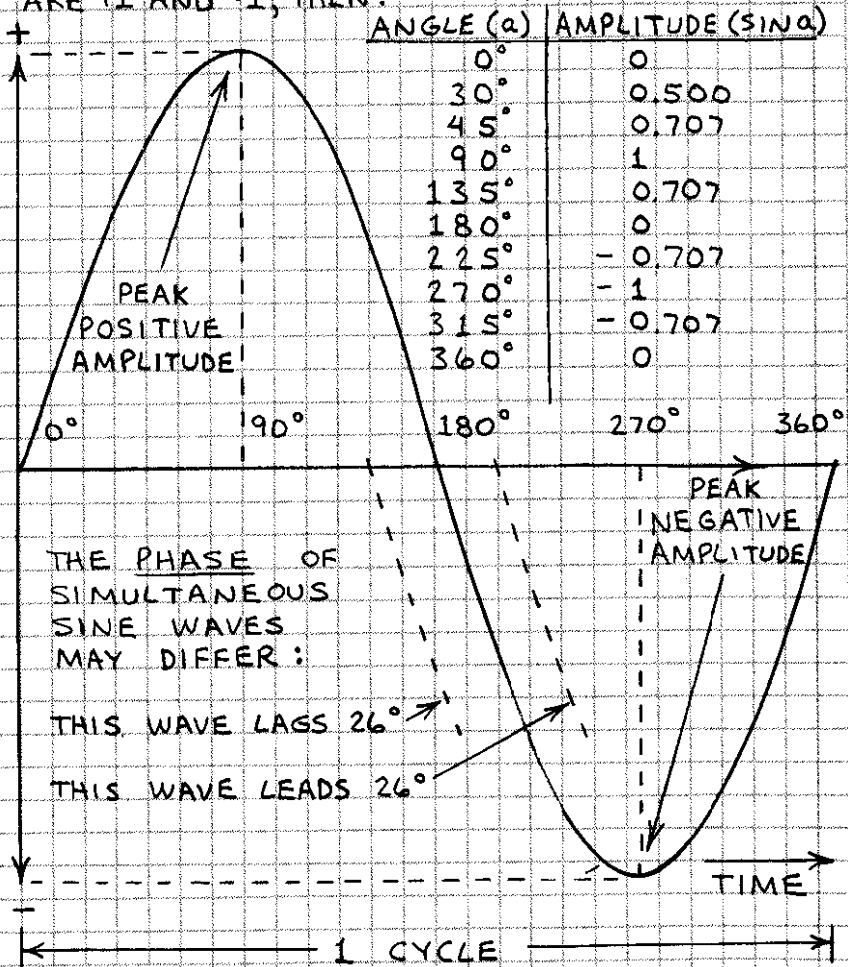

FREQUENCY OF A SINE WAVE IS THE NUMBER OF CYCLES PER SECOND. HERTZ (Hz) IS THE UNIT OF FREQUENCY. ONE HERTZ (1Hz) IS ONE CYCLE PER SECOND (1 CPS).

PERIOD OF A SINE WAVE IS THE TIME FOR ONE COMPLETE CYCLE TO OCCUR.

PERIODIC WAVES

MANY DIFFERENT PERIODIC WAVE FORMS CAN BE PROCESSED OR GENERATED BY ANALOG ELECTRONIC CIRCUITS. THEY INCLUDE:

SQUARE WAVE

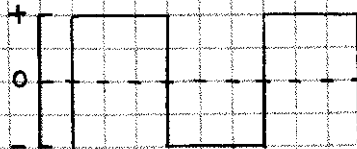

RECTANGULAR WAVE

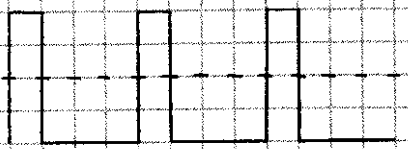

TRIANGLE WAVE

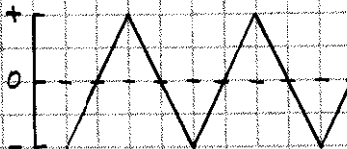

SAWTOOTH WAVE

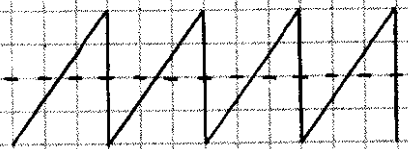

PERIODIC WAVES CAN BE RECTIFIED BY DIODES AND CLIPPED BY ZENER DIODES:

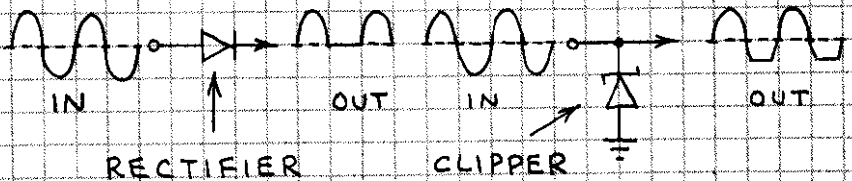

HALF-WAVE RECTIFIED SINE WAVE

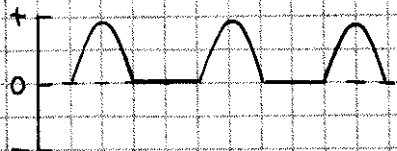

FULL-WAVE RECTIFIED SINE WAVE

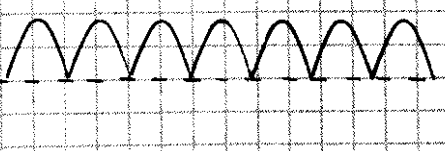

CLIPPED SAWTOOTH

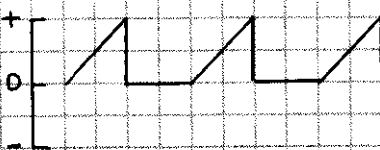

TRAPEZOIDAL WAVE

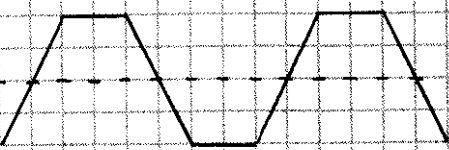

PULSES

SINGLE PULSES OR TRAINS OF PERIODIC PULSES ARE PROCESSED AND GENERATED BY DIGITAL ELECTRONIC CIRCUITS. THEY ARE ALSO USED TO TRIGGER (ACTIVATE) MANY KINDS OF CIRCUITS.

THE IDEAL PULSE

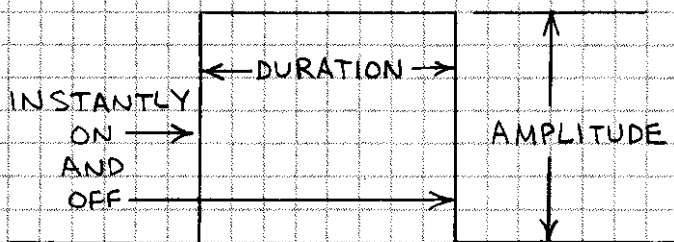

A REAL PULSE

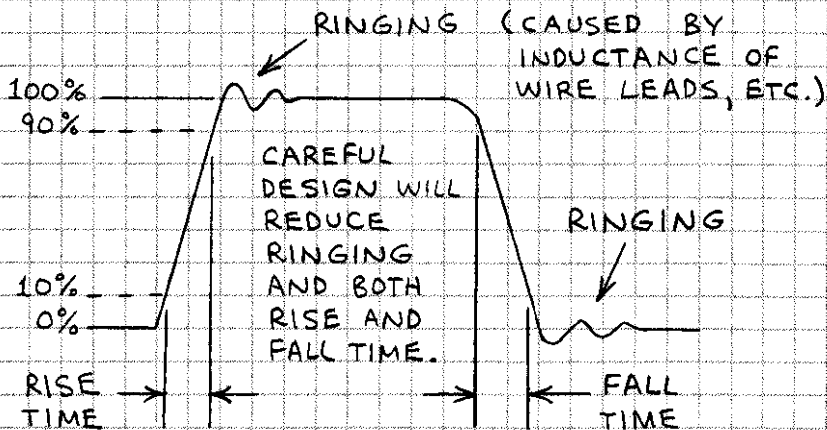

PULSE TRAIN

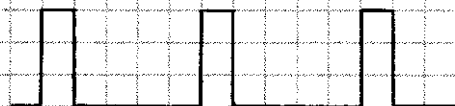

THE NUMBER OF PULSES PER SECOND IS THE PULSE REPETITION RATE.

SIGNALS

ELECTRONIC SIGNALS RANGE FROM AUDIBLE TONES TO COMPLEX INFORMATION CARRIED BY A FLUCTUATING (ANALOG) OR PULSATING (DIGITAL) WAVE, CURRENT OR VOLTAGE. MANY MODULATION METHODS ARE USED TO IMPRESS A SIGNAL ON A CARRIER.

MODULATION METHODS

ANALOG

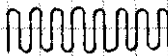
UNMODULATED CARRIER WAVE 

ANALOG SIGNAL 

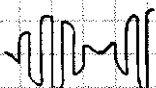
AMPLITUDE MODULATION 

FREQUENCY MODULATION 

PULSE

ANALOG SIGNAL 

PULSE AMPLITUDE 

PULSE DURATION 

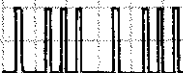
PULSE FREQUENCY 

DIGITAL

BINARY BIT PATTERN

0 0 0 1 0 1 0 1 1 0 0

NON-RETURN TO ZERO (NRZ)



RETURN TO ZERO (RZ)



MANCHESTER



FREQUENCY SHIFT KEYING (FSK)



4. CODES AND SYMBOLS

ALPHABET, ASCII & MORSE CODE

ALPHABET	ASCII		MORSE CODE
A	1 0 0	0 0 0 1	· -
B	1 0 0	0 0 1 0	- · · ·
C	1 0 0	0 0 1 1	- · - ·
D	1 0 0	0 1 0 0	- · ·
E	1 0 0	0 1 0 1	· · ·
F	1 0 0	0 1 1 0	· · - ·
G	1 0 0	0 1 1 1	- - ·
H	1 0 0	1 0 0 0	· · · ·
I	1 0 0	1 0 0 1	· · ·
J	1 0 0	1 0 1 0	· - - -
K	1 0 0	1 0 1 1	- - · -
L	1 0 0	1 1 0 0	· - · ·
M	1 0 0	1 1 0 1	- -
N	1 0 0	1 1 1 0	- ·
O	1 0 0	1 1 1 1	- - -
P	1 0 1	0 0 0 0	· - - ·
Q	1 0 1	0 0 0 1	- - · -
R	1 0 1	0 0 1 0	· - · ·
S	1 0 1	0 0 1 1	· · · ·
T	1 0 1	0 1 0 0	· · · -
U	1 0 1	0 1 0 1	· · · -
V	1 0 1	0 1 1 0	· · · -
W	1 0 1	0 1 1 1	· · - -
X	1 0 1	1 0 0 0	- · · -
Y	1 0 1	1 0 0 1	- · - -
Z	1 0 1	1 0 1 0	- - · ·
0	0 1 1	0 0 0 0	- - - -
1	0 1 1	0 0 0 1	· - - -
2	0 1 1	0 0 1 0	· · - -
3	0 1 1	0 0 1 1	· · · -
4	0 1 1	0 1 0 0	· · · · -
5	0 1 1	0 1 0 1	· · · · ·
6	0 1 1	0 1 1 0	- · · · ·
7	0 1 1	0 1 1 1	- - · · ·
8	0 1 1	1 0 0 0	- - - · ·
9	0 1 1	1 0 0 1	- - - ·

ASCII

					0	0	1	1	1	1		
					1	1	0	0	1	1		
					0	1	0	1	0	1		
					0	2	3	4	5	6	7	
					1							
COLUMN					0	1	2	3	4	5	6	7
ROW					0	1	2	3	4	5	6	7
		0	0	0	0	SP	0	@	P	'	P	
		0	0	0	1	!	1	A	Q	q	q	
		0	0	1	0	"	2	B	R	r	r	
		0	0	1	1	#	3	C	S	s	s	
		0	1	0	0	\$	4	D	T	t	t	
		0	1	0	1	%	5	E	U	e	e	
		0	1	1	0	&	6	F	V	f	f	
		0	1	1	1	'	7	G	W	w	w	
		1	0	0	0	(8	H	X	h	h	
		1	0	0	1)	9	I	Y	i	i	
		1	0	1	0	*	:	J	Z	j	j	
		1	0	1	1	+	;	K	[k	k	
		1	1	0	0	,	<	L	\	l	l	
		1	1	0	1	-	=	M]	m	m	
		1	1	1	0	.	>	N	^	n	n	
		1	1	1	1	/	?	O	_	o	o	DEL

SP - SPACE

CONTROL CHARACTERS
(NON PRINTING)

ASCII - AMERICAN STANDARD CODE FOR INFORMATION INTERCHANGE. ASCII IS THE PRINCIPLE COMPUTER KEYBOARD CODE. ASSEMBLY LANGUAGE PROGRAMMERS CONVERT BINARY ASCII (ABOVE) TO HEXADECIMAL. PRINCIPLE HEX EQUIVALENTS:

A-41	G-47	M-4D	S-53	Y-59	4-34
B-42	H-48	N-4E	T-54	Z-5A	5-35
C-43	I-49	O-4F	U-55	Ø-30	6-36
D-44	J-4A	P-50	V-56	1-31	7-37
E-45	K-4B	Q-51	W-57	2-32	8-38
F-46	L-4C	R-52	X-58	3-33	9-39

GREEK ALPHABET

NAME	U	L	NAME	U	L
ALPHA	A	α	NU	ν	ν
BETA	B	β	XI	ξ	ξ
GAMMA	Γ	γ	OMICRON	\omicron	\omicron
DELTA	Δ	δ	PI	π	π
EPSILON	E	ϵ	RHO	ρ	ρ
ZETA	Z	ζ	SIGMA	σ	σ
ETA	H	η	TAU	τ	τ
THETA	θ	θ	UPSILON	υ	υ
IOTA	I	ι	PHI	ϕ	ϕ
KAPPA	K	κ	CHI	χ	χ
LAMBDA	Λ	λ	PSI	ψ	ψ
MU	M	μ	OMEGA	ω	ω

U - UPPER CASE

L - LOWER CASE

COMMON GREEK SYMBOLS

LETTER	SYMBOLIZES OR DESIGNATES
α	ANGLES, ACCELERATION, AREA
β	ANGLES,
γ	CONDUCTIVITY, SPECIFIC GRAVITY
Δ	INCREMENT, DECREMENT
ϵ	DIELECTRIC CONSTANT
E	ENERGY
Z	IMPEDANCE
η	FM MODULATION INDEX
θ	ANGLES, TIME CONSTANT, TEMPERATURE
λ	WAVELENGTH, CONDUCTIVITY
μ	MICRO (PREFIX), AMPLIFICATION FACTOR
ν	FREQUENCY
π	CIRCUMFERENCE \div DIAMETER (3.14159...)
ρ	RESISTIVITY, REFLECTANCE
Σ	SUMMATION SIGN
τ	TIME CONSTANT, TRANSMITTANCE
ϕ	ANGLE, RADIANT POWER
ω	ANGLE, ANGULAR FREQUENCY
Ω	SOLID ANGLE, RESISTANCE (OHMS)

RESISTOR COLOR CODE

COLOR	SIGNIFICANT DIGITS (1&2)	MULTIPLIER (3)	TOL.(4)
BLACK	0	1	
BROWN	1	10	± 1%
RED	2	100	
ORANGE	3	1,000	
YELLOW	4	10,000	NO
GREEN	5	100,000	COLOR
BLUE	6	1,000,000	BAND:
VIOLET	7	10,000,000	± 20%
GRAY	8	100,000,000	
WHITE	9	-	
GOLD	-	-	± 5%
SILVER	-	-	± 10%

EXAMPLE:



1 = BROWN = 1
 2 = BLACK = 0
 3 = YELLOW = x 10,000
 4 = SILVER = ± 10% TOLERANCE

100,000 Ω
 ± 10%

TRANSFORMER COLOR CODE

AUDIO INTERSTAGE AND OUTPUT:



POWER: UNTAPPED PRIMARY - BLACK; FILAMENT SECONDARY - GREEN (ADDITIONAL FILAMENT - YELLOW, BROWN AND SLATE); HIGH-VOLTAGE SECONDARY - RED. COLORS MAY VARY.

NOTE: THESE ARE EIA RECOMMENDED COLORS. SEE TRANSFORMER SPECIFICATIONS TO VERIFY CODE.

5. ELECTRONIC ABBREVIATIONS

AC - ALTERNATING CURRENT
AF - AUDIO FREQUENCY
AFC - AUTOMATIC FREQUENCY CONTROL
AGC - AUTOMATIC GAIN CONTROL
AM - AMPLITUDE MODULATION
AMP - AMPLIFIER
ANL - AUTOMATIC NOISE LIMITER
ANT - ANTENNA
AVC - AUTOMATIC VOLUME CONTROL
AWG - AMERICAN WIRE GAUGE
B - BASE OF TRANSISTOR
BC - BROADCAST
BFO - BEAT FREQUENCY OSCILLATOR
BP - BANDPASS
C - COLLECTOR OF TRANSISTOR
CAL - CALIBRATE
CAP - CAPACITOR
CB - CITIZENS BAND
CKT - CIRCUIT
CLK - CLOCK
CRT - CATHODE RAY TUBE
C/S - CYCLES PER SECOND (HERTZ; HZ)
CT - CENTER TAP
CW - CONTINUOUS WAVE
CY - CYCLE
°C - DEGREES CELSIUS
D - DRAIN OF FET
dB - DECIBEL
DBLR - DOUBLER
DC - DIRECT CURRENT
DEG - DEGREES
DEM0D - DEMODULATION
DF - DIRECTION FINDER
DPDT - DOUBLE POLE DOUBLE THROW
DPST - DOUBLE POLE SINGLE THROW
DSB - DOUBLE SIDEBAND
E - EMITTER OF TRANSISTOR ; ENERGY
EM - ELECTROMAGNETIC
EMF - ELECTROMOTIVE FORCE
EMP - ELECTROMAGNETIC PULSE
ERP - EFFECTIVE RADIATED POWER

F - FREQUENCY
°F - DEGREES FAHRENHEIT
FDBK - FEEDBACK
FET - FIELD EFFECT TRANSISTOR
FF - FLIP FLOP
FIL - FILAMENT
FM - FREQUENCY MODULATION
FREQ - FREQUENCY
FSC - FULL SCALE
FWHM - FULL WIDTH HALF MAXIMUM
G - GATE OF FET
GA - GAUGE
GND - GROUND
HF - HIGH FREQUENCY
HI FI - HIGH FIDELITY
HV - HIGH VOLTAGE
HZ - HERTZ
I - CURRENT
IC - INTEGRATED CIRCUIT
IMPD - IMPEDANCE
IR - INFRARED
JFET - JUNCTION FIELD EFFECT TRANSISTOR
KWH - KILOWATT HOUR
LED - LIGHT EMITTING DIODE
LP - LOW PASS
LSI - LARGE SCALE INTEGRATION
MA - MILLIAMPERES
MIC - MICROPHONE
MOS - METAL-OXIDE-SEMICONDUCTOR
MOSFET - MOS FIELD EFFECT TRANSISTOR
NC - NO CONTACT
NEG - NEGATIVE
NF - NOISE FIGURE
NO - NORMALLY OPEN
NOM - NOMINAL
NPN - NEGATIVE - POSITIVE - NEGATIVE
OP AMP - OPERATIONAL AMPLIFIER
OSC - OSCILLATOR
OUT - OUTPUT
PAM - PULSE AMPLITUDE MODULATION
PC - PRINTED CIRCUIT
PCM - PULSE CODE MODULATION
PDM - PULSE DURATION MODULATION

PF - PICO FARAD
PFM - PULSE FREQUENCY MODULATION
PK - PEAK
PLL - PHASE LOCKED LOOP
PNP - POSITIVE - NEGATIVE - POSITIVE
POS - POSITIVE
POT - POTENTIOMETER
PREAMP - PREAMPLIFIER
PRI - PRIMARY
PRV - PEAK REVERSE VOLTAGE
PVC - POLYVINYL CHLORIDE
PWR - POWER
PWR SUP - POWER SUPPLY
PZ - PIEZOELECTRIC
Q - QUALITY FACTOR
QTZ - QUARTZ
R - RESISTANCE
RAD - RADIAN
RC - RESISTANCE - CAPACITANCE
RCDR - RECORDER
RCV - RECEIVE
RCVR - RECEIVER
RECHRG - RECHARGE
RECT - RECTIFIER
REF - REFERENCE
RF - RADIO FREQUENCY
RFC - RADIO FREQUENCY CHOKE
RFI - RADIO FREQUENCY INTERFERENCE
RL - RESISTANCE - INDUCTANCE
RLC - RESISTANCE - INDUCTANCE - CAPACITANCE
RLY - RELAY
RMS - ROOT MEAN SQUARE
RMT - REMOTE
ROT - ROTATE
RPM - REVOLUTIONS PER MINUTE
RPS - REVOLUTIONS PER SECOND
RTTY - RADIO TELETYPEWRITER
RY - RELAY
S - SOURCE OF FET
SB - SIDEBAND
SCR - SILICON CONTROLLED RECTIFIER
SEC - SECONDARY
SERVO - SERVOMECHANISM

SHLD - SHIELD
SIG - SIGNAL
SNR - SIGNAL-TO-NOISE RATIO (ALSO S/N)
SPDT - SINGLE POLE DOUBLE THROW
SPKR - SPEAKER
SPST - SINGLE POLE SINGLE THROW
SQ - SQUARE
SSB - SINGLE SIDEBAND
SUBMIN - SUBMINIATURE
SW - SHORTWAVE
SWL - SHORTWAVE LISTENING
SWR - STANDING WAVE RATIO
SYM - SYMBOL
T - TIME
TACH - TACHOMETER
TEL - TELEPHONE
TELECOM - TELECOMMUNICATIONS
TEMP - TEMPERATURE
TERM - TERMINAL
TRF - TUNED RADIO FREQUENCY
TTL - TRANSISTOR-TRANSISTOR LOGIC
TVI - TELEVISION INTERFERENCE
UHF - ULTRA HIGH FREQUENCY
UJT - UNIJUNCTION TRANSISTOR
UTC - COORDINATED UNIVERSAL TIME
V - VOLTAGE
VAC - VACUUM; AC VOLTAGE
VC - VOICE COIL
VCO - VOLTAGE CONTROLLED OSCILLATOR
VF - VARIABLE FREQUENCY
VHF - VERY HIGH FREQUENCY
VID - VIDEO
VLF - VERY LOW FREQUENCY
VOL - VOLUME
VOM - VOLT-OHM METER
VT - VACUUM TUBE
VOX - VOICE-OPERATED TRANSMITTER
W - WATT
WHM - WATT-HOUR METER
WV - WORKING VOLTAGE
X - REACTANCE
XMTR - TRANSMITTER
Z - IMPEDANCE

6. BASIC ELECTRONIC CIRCUITS

HALF-WAVE RECTIFIER

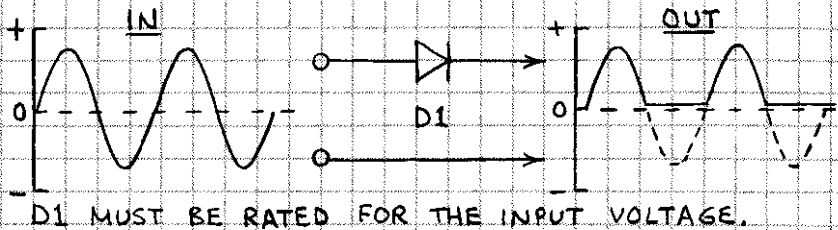

FULL-WAVE RECTIFIER

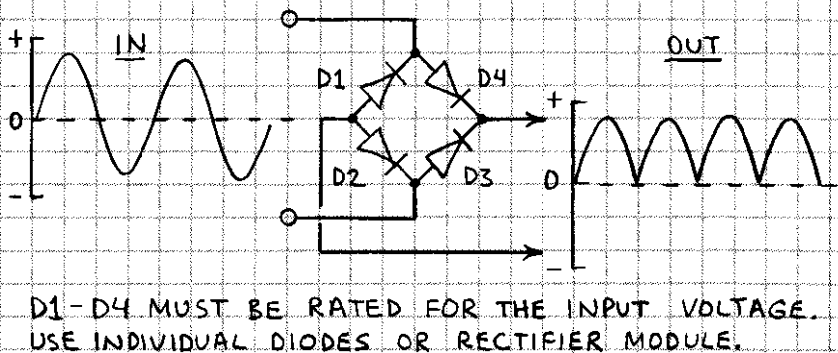

VOLTAGE DOUBLER

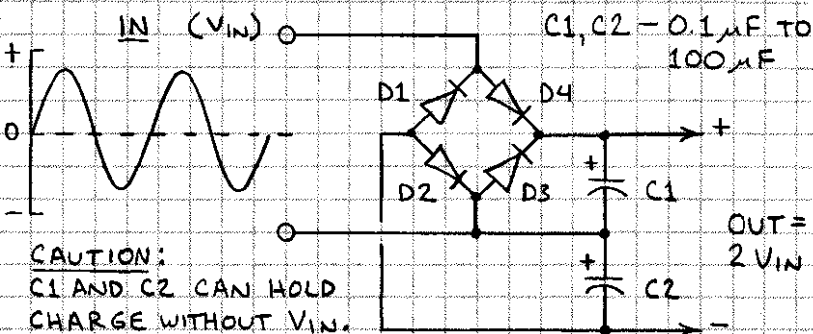

D1 - D4, C1 AND C2 MUST BE RATED FOR AT LEAST TWICE THE INPUT VOLTAGE.

BASIC LED DRIVER



$$R_s = \frac{V_{IN} - V_{LED}}{I_{LED}}$$

V_{IN} = INPUT VOLTAGE

I_{LED} = LED FORWARD CURRENT (DESIRED OR SPECIFIED)

V_{LED} = LED VOLTAGE DROP

EXAMPLE: ASSUME $V_{IN} = 9$ VOLTS AND $V_{LED} = 1.7$ VOLTS. CALCULATE VALUE OF R_s FOR $I_{LED} = 20$ mA.

$$R_s = \frac{9 - 1.7}{.02} = 365 \text{ OHMS (OK TO USE CLOSEST STANDARD VALUE)}$$

LOGIC GATE LED DRIVERS

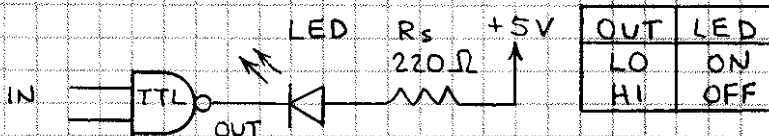

NOTE: CMOS WILL DIRECTLY DRIVE SUPER BRIGHT LEDS IF I_{LED} IS KEPT BELOW A FEW MILLIAMPERES.

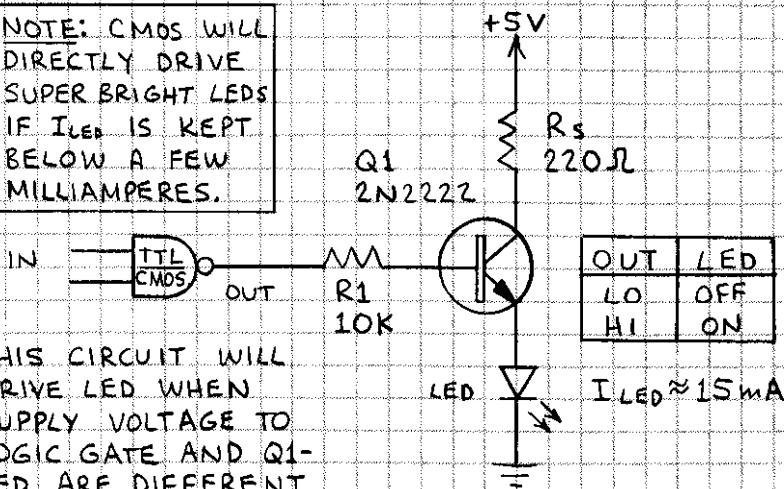

THIS CIRCUIT WILL DRIVE LED WHEN SUPPLY VOLTAGE TO LOGIC GATE AND Q1-LED ARE DIFFERENT.

INVERTING AMPLIFIER

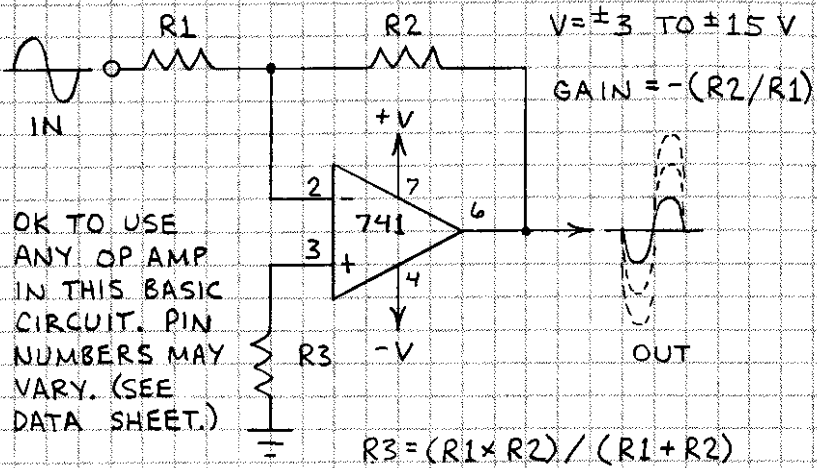

EXAMPLE: IF $R1 = 4,700 \text{ OHMS}$ AND $R2 = 47,000 \text{ OHMS}$, THEN GAIN IS $-(47,000/4,700)$ OR -10 .
 $R3 = 4,273 \text{ OHMS}$ (USE CLOSEST STANDARD VALUE).

NON-INVERTING AMPLIFIER

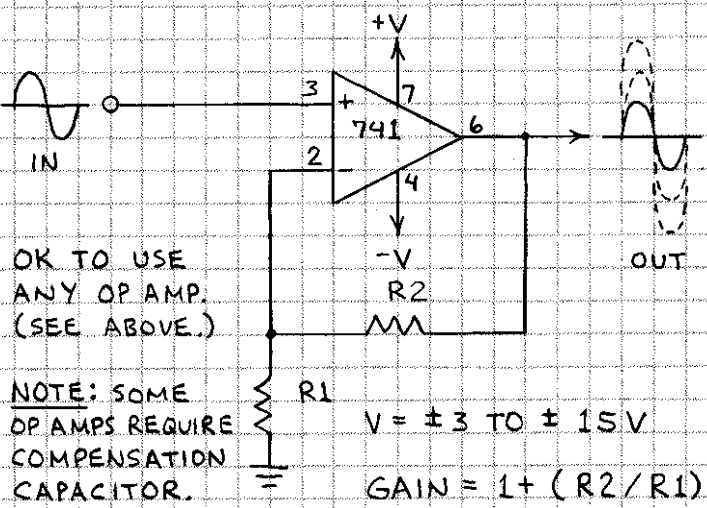

EXAMPLE: IF $R1 = 4,700 \text{ OHMS}$ AND $R2 = 47,000 \text{ OHMS}$, THEN GAIN IS $1 + (47,000/4,700)$ OR 11 .

VOLTAGE-TO-CURRENT CONVERTER

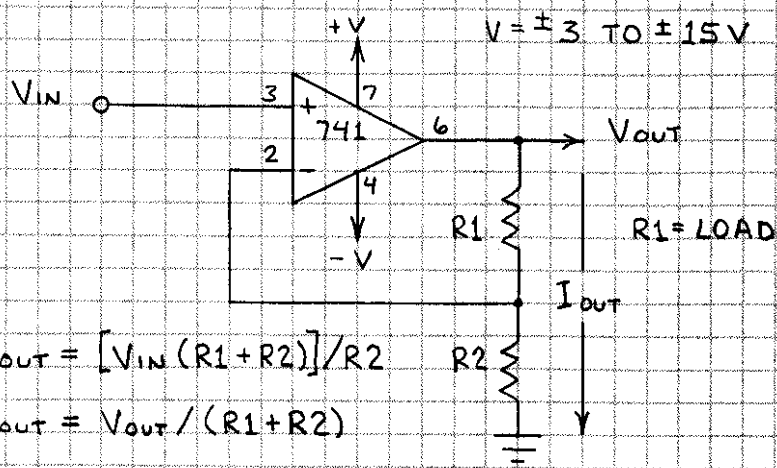

$$V_{OUT} = [V_{IN} (R_1 + R_2)] / R_2$$

$$I_{OUT} = V_{OUT} / (R_1 + R_2)$$

$$I_{OUT} = V_{IN} / R_2$$

EXAMPLE: ASSUME R1 IS A RESISTOR AND LED WITH COMBINED RESISTANCE OF 1,000 OHMS AND R2 IS 470 OHMS. WHEN VIN = 5 VOLTS, CURRENT (IOUT) THROUGH LED IS 10.6 MA.

CURRENT-TO-VOLTAGE CONVERTER

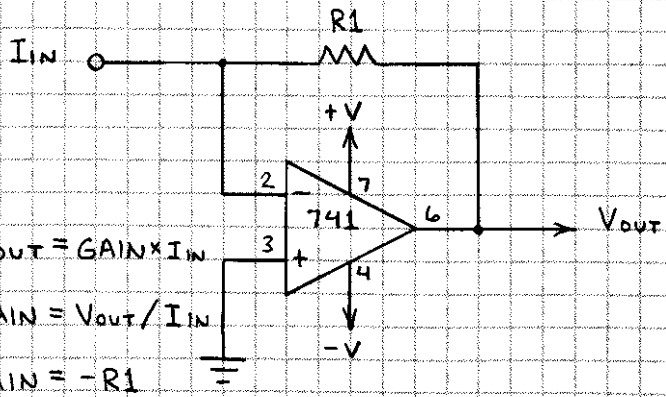

$$V_{OUT} = GAIN \times I_{IN}$$

$$GAIN = V_{OUT} / I_{IN}$$

$$GAIN = -R_1$$

EXAMPLE: ASSUME A SOLAR CELL CONNECTED TO IIN DELIVERS A CURRENT OF 1 MA. IF R1 IS 1,000 OHMS, THEN VOUT = -(1,000 × 0.001) = -1 VOLT.

INVERTING COMPARATOR

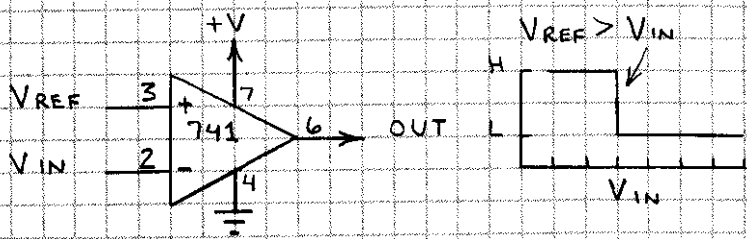

WHEN V_{REF} EXCEEDS V_{IN} , OUTPUT SWINGS FROM HIGH TO LOW.

NON-INVERTING COMPARATOR

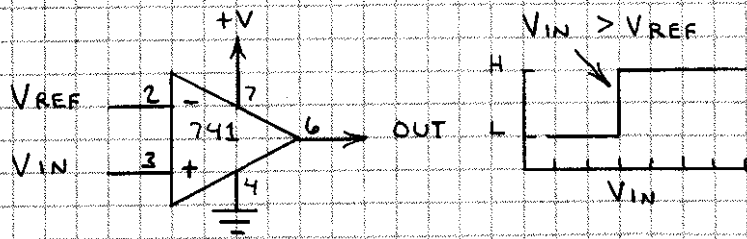

WHEN V_{IN} EXCEEDS V_{REF} , OUTPUT SWINGS FROM LOW TO HIGH.

WINDOW COMPARATOR

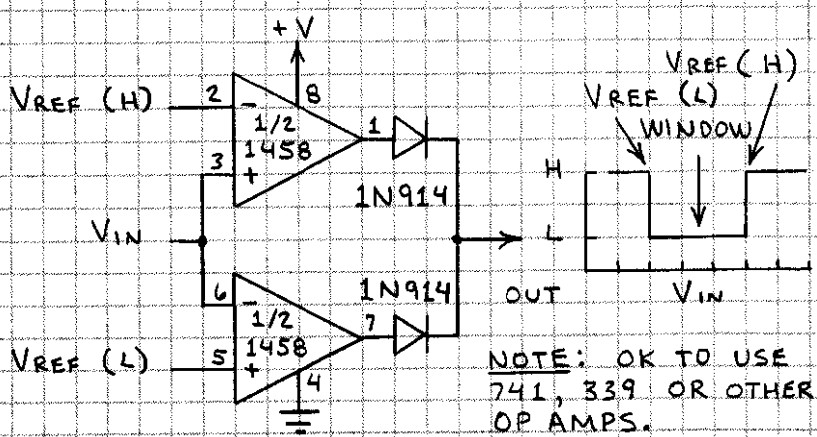

NOTE: OK TO USE 741, 339 OR OTHER OP AMPS.

TIMER

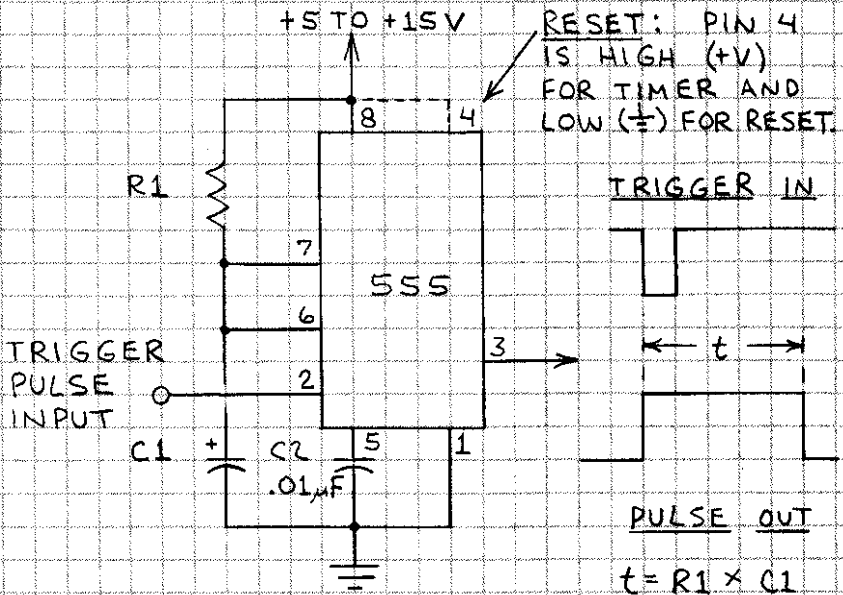

PULSE GENERATOR

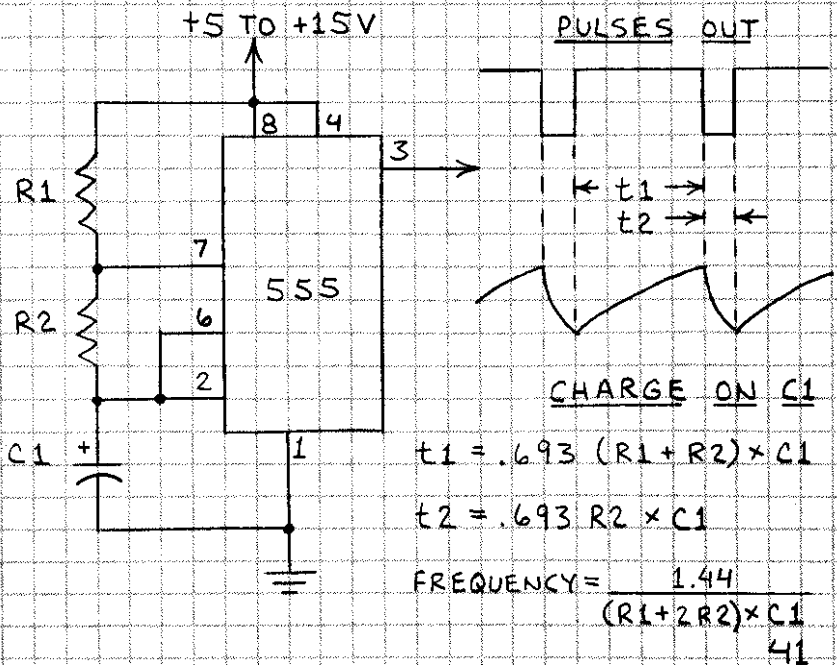

7. BASIC LOGIC CIRCUITS

AND GATE

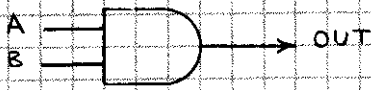

A	B	OUT
L	L	L
L	H	L
H	L	L
H	H	H

NAND GATE

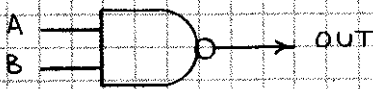

A	B	OUT
L	L	H
L	H	H
H	L	H
H	H	L

OR

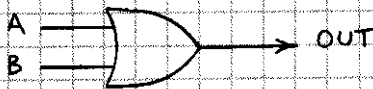

A	B	OUT
L	L	L
L	H	H
H	L	H
H	H	H

NOR

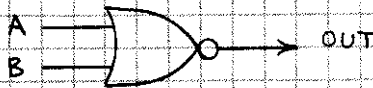

A	B	OUT
L	L	H
L	H	L
H	L	L
H	H	L

EXCLUSIVE OR

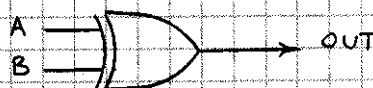

A	B	OUT
L	L	L
L	H	H
H	L	H
H	H	L

EXCLUSIVE NOR

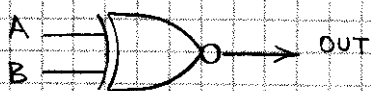

A	B	OUT
L	L	H
L	H	L
H	L	L
H	H	H

BUFFER (3-STATE BUFFER)

C --- C=CONTROL

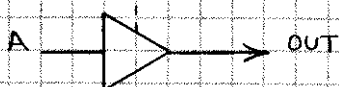

X = DON'T CARE

(C)	A	OUT
(L)	L	L
(L)	H	H
(H)	(X)	(HI-Z)

INVERTER (3-STATE INVERTER)

C --- C=CONTROL

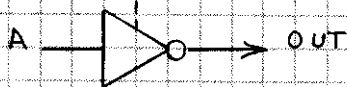

X = DON'T CARE

(C)	A	OUT
(L)	L	H
(L)	H	L
(H)	(X)	(HI-Z)

3-STATE BUS

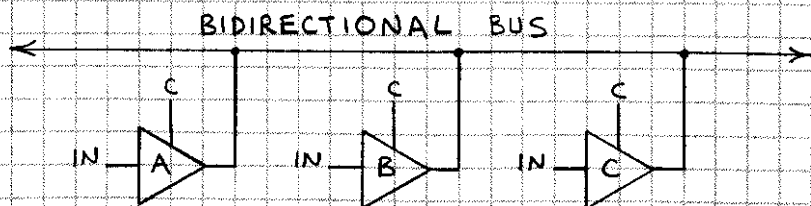

COMPUTERS
USUALLY HAVE
A 3-STATE
BUS.

CONTROL			GATE OUTPUT TO BUS
A	B	C	
L	H	H	A
H	L	H	B
H	H	L	C
H	H	H	NONE

RS FLIP-FLOP (LATCH)

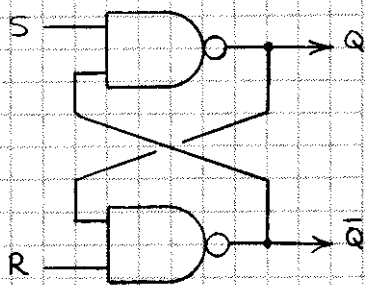

S	R	Q	\bar{Q}
L	L	(DISALLOWED)	
L	H	H	L
H	L	L	H
H	H	NO CHANGE	

\bar{Q} = NOT Q

CLOCKED RS FLIP-FLOP

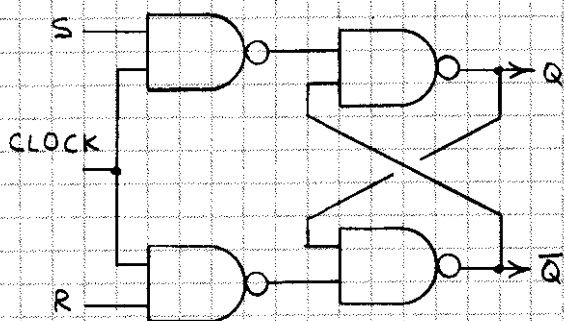

AFTER CLOCK PULSE ARRIVES:

S	R	Q	\bar{Q}
L	L	NO CHANGE	
L	H	L	H
H	L	H	L
H	H	(DISALLOWED)	

JK FLIP-FLOP

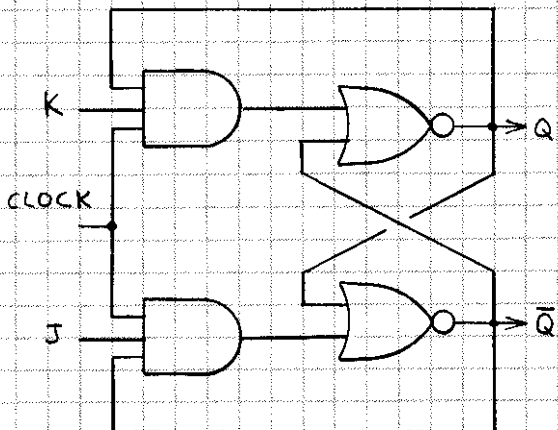

AFTER CLOCK PULSE ARRIVES:

J	K	Q	\bar{Q}
L	L	NO CHANGE	
L	H	L	H
H	L	H	L
H	H	TOGGLE*	

*SEE FACING PAGE.

D (DATA OR DELAY) FLIP-FLOP

AFTER CLOCK PULSE ARRIVES:

D	Q	\bar{Q}
L	L	H
H	H	L

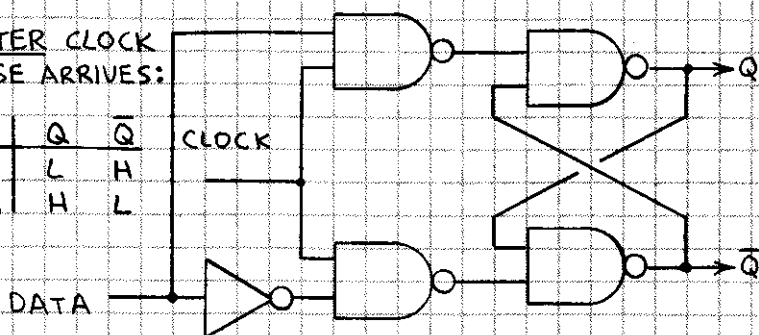

T (TOGGLE) FLIP-FLOPS

THE Q (OR \bar{Q}) OUTPUT IS L (OR H) FOR EVERY OTHER INPUT PULSE. THEREFORE THE OUTPUT IS THE INPUT $\div 2$:

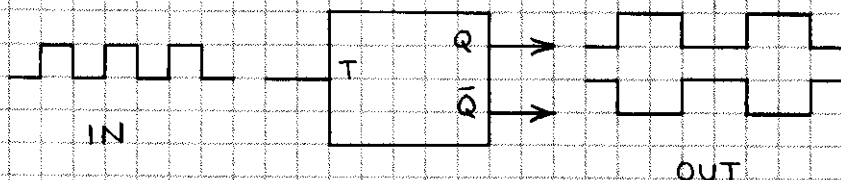

CHAINS OF T FLIP-FLOPS ARE USED TO MAKE BINARY COUNTERS. THE JK FLIP-FLOP (FACING PAGE) FUNCTIONS AS A T FLIP-FLOP WHEN BOTH THE J AND K INPUTS ARE KEPT HIGH AND INPUT PULSES ARE APPLIED TO THE CLOCK INPUT. OTHER T FLIP-FLOPS:

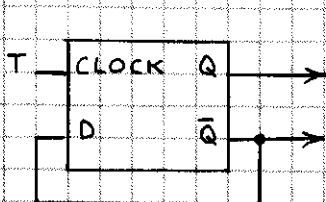

D FLIP-FLOP

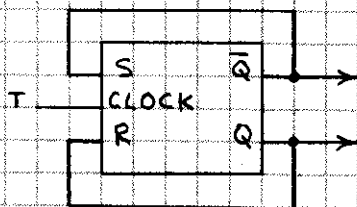



CLOCKED RS FLIP-FLOP

8. POWER SUPPLIES

BATTERIES

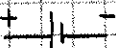
SYMBOLS

SINGLE CELL:  MULTIPLE CELL: 

CONNECTIONS

SERIES:



PARALLEL:

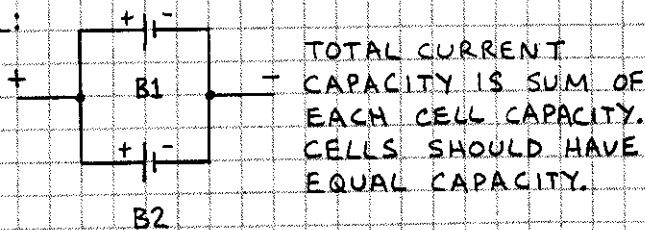

BIPOLAR:

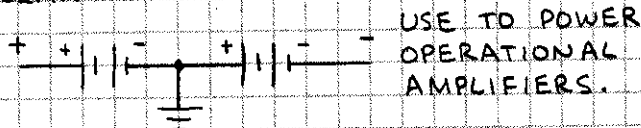

STORAGE BATTERIES

STORAGE BATTERIES CAN BE USED AND RECHARGED MANY TIMES. PRINCIPLE TYPES:

LEAD-ACID — 2.0 VOLTS PER CELL. HIGH CURRENT CAPACITY. GOOD AT LOW TEMPERATURE.

NICKEL-CADMIUM (NICAD) — 1.2 VOLTS PER CELL. CAN BE STORED FOR EXTENDED TIME WHEN DISCHARGED. MANY DIFFERENT KINDS AVAILABLE. VERY ECONOMICAL POWER SOURCE.

PRIMARY BATTERIES

PRIMARY BATTERIES ARE NOT RECHARGEABLE. CHIEF AMONG THE MANY TYPES AVAILABLE:

CARBON-ZINC—1.5 VOLTS PER CELL. READILY AVAILABLE AND LOW COST.

ZINC-CHLORIDE—1.5 VOLTS PER CELL. TWICE THE ENERGY DENSITY OF CARBON-ZINC.

ALKALINE—1.5 VOLTS PER CELL. USE FOR HIGH CURRENT LOADS (MOTORS, LAMPS, ETC.).

MERCURY—1.35 AND 1.4 VOLTS PER CELL. UNIFORM VOLTAGE DURING DISCHARGE.

SILVER OXIDE—1.5 VOLTS PER CELL. NEARLY UNIFORM VOLTAGE DURING DISCHARGE.

LITHIUM MANGANESE—3.0 VOLTS PER CELL. EXCEPTIONALLY LONG STORAGE LIFE. VERY HIGH ENERGY DENSITY.

BATTERY PRECAUTIONS

1. DO NOT CHARGE PRIMARY CELLS.
2. BATTERIES MAY EXPLODE WHEN HEATED.
3. DO NOT SOLDER LEADS TO A BATTERY. USE A BATTERY CLIP OR HOLDER.
4. NEVER SHORT CIRCUIT A BATTERY'S TERMINALS.
5. MOST BATTERIES SHOULD BE REMOVED FROM EQUIPMENT IN STORAGE. EXCEPTIONS ARE STORAGE BATTERIES AND LITHIUM CELLS.
6. WHEN BATTERY LEADS EXCEED ≈ 6 INCHES, CONNECT $0.1 \mu\text{F}$ CAPACITOR ACROSS LEADS AT CIRCUIT BOARD.

LINE-POWERED SUPPLY

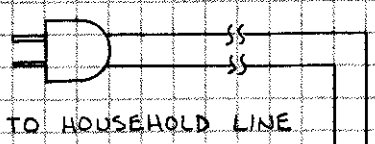

CAUTION: ALL CONNECTIONS THAT CARRY LINE CURRENT MUST BE INSULATED OR ENCLOSED! DISCONNECT POWER WHEN SERVICING!

F1: FUSE
(SELECT TO MATCH CURRENT RATING OF T1.)

F1
S1 SPST POWER SWITCH

PRIMARY 120 VAC

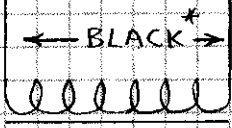

T1: POWER TRANSFORMER

SECONDARY 6.3 TO 25 VAC

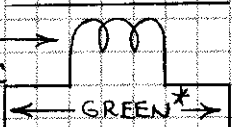

(CURRENT RATING MUST EXCEED MAXIMUM OUTPUT.)

B1: 1 TO 4 AMP BRIDGE RECTIFIER RATED FOR AT LEAST 2x SECONDARY VOLTAGE OF T1.

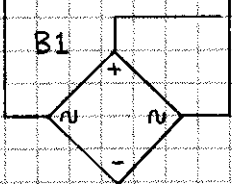

*COLORS MAY VARY. SOME TRANSFORMERS HAVE SOLDER LUGS INSTEAD OF WIRE LEADS.

C1, C2 - 1,000 μF 35 VDC

(FRONT)

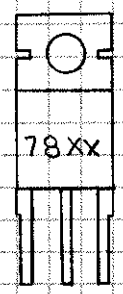

7805 - 5V
7812 - 12V
7815 - 15V

ATTACH HEAT SINK TO METAL TAB IF NECESSARY.

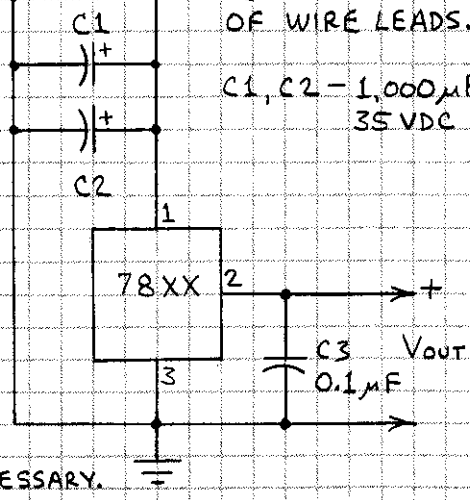

RESISTOR COLOR CODE



BLACK	0	0	$\times 1$
BROWN	1	1	$\times 10$
RED	2	2	$\times 100$
ORANGE	3	3	$\times 1,000$
YELLOW	4	4	$\times 10,000$
GREEN	5	5	$\times 100,000$
BLUE	6	6	$\times 1,000,000$
VIOLET	7	7	$\times 10,000,000$
GRAY	8	8	$\times 100,000,000$
WHITE	9	9	—

FOURTH BAND INDICATES TOLERANCE (ACCURACY):
GOLD = $\pm 5\%$ SILVER = $\pm 10\%$ NONE = $\pm 20\%$

OHM'S LAW: $V = IR$ $R = V/I$
 $I = V/R$ $P = VI = I^2R$

ABBREVIATIONS

A = AMPERE	R = RESISTANCE
F = FARAD	V (OR E) = VOLT
I = CURRENT	W = WATT
P = POWER	Ω = OHM

M (MEG-)	= $\times 1,000,000$
K (KILO-)	= $\times 1,000$
m (MILLI-)	= .001
μ (MICRO-)	= .000 001
n (NANO-)	= .000 000 001
p (PICO-)	= .000 000 000 001

Radio Shack

A Division of Tandy Corporation
Fort Worth, TX 76102

PRINTED IN U.S.A.

62-5016



0 40293 10895 3