

VT510 Video Terminal

Installation and Operating Information

Order Number: 598-0013866

November 1996

Boundless Technologies makes no representations that the use of its products in the manner described in this publication will not infringe on existing or future patent rights, nor do the descriptions contained in this publication imply the granting of licenses to make, use, or sell equipment or software in accordance with the description.

DEC, OpenVMS, ULTRIX, VMS, and VT are trademarks of Digital Equipment Corporation.

ADDS is a trademark of Applied Digital Data Systems, Inc.

IBM, ProPrinter, and PS/2 are registered trademarks of International Business Machines Corporation.

SCO is a trademark of Santa Cruz Operations, Inc.

TVI is a trademark of TeleVideo, Inc.

UNIX is a registered trademark of UNIX System Laboratories, Inc.

WY and WYSE are registered trademarks of Wyse Technologies.

All other trademarks and registered trademarks are the property of their respective holders.

© Boundless Technologies, Inc. 1996-2009

All Rights Reserved.

Printed in USA

FCC ID: CR8-VGB10—NOTE: The North American version of this equipment has been tested and found to comply with the limits for a Class A digital device, pursuant to Part 15 of FCC Rules. These limits are designed to provide reasonable protection against harmful interference when the equipment is operated in a commercial environment. This equipment generates, uses, and can radiate radio frequency energy and, if not installed and used in accordance with the instruction manual, may cause harmful interference to radio communications. Operation of this equipment in a residential area is likely to cause harmful interference, in which case, the user will be required to correct the interference at his own expense.

Canadian Standards Association (CSA) Statement

This digital apparatus does not exceed the Class A limits for radio noise emissions from digital apparatus as set out in the radio interference regulations of the Canadian Department of Communications.

Le présent appareil numérique n'émet pas de bruits radioélectriques dépassant les limites applicables aux appareils numériques de class A prescrites dans le règlement sur le brouillage radioélectrique édicté par le Ministère des Communications du Canada.

Use of Ozone Depleting Substance (ODS)

The VT510 is in full compliance with the labeling requirements in the US Clean Air Act Amendments of 1990. It does not contain, nor is it manufactured with, a Class 1 ODS, as defined in Title VI Section 611 of this act.



Contents

Preface	Vv
Overview	vv
Environment	vv
Before you Start	vv
Conventions	viivii
Proper Setup and Use	viivii
1 Installation and Set-Up	1-1
Install the tilt/swivel stand	1-1
Install your terminal	1-2
Connect the cables to the terminal	1-2
Plug in the power cord and push the power switch on	1-3
Set the Brightness and Contrast controls	1-3
“Selftest OK” appears on the screen	1-3
Set up your terminal	1-4
Entering Set-Up	1-4
Moving within a Set-Up Menu	1-5
Keyboards	1-5
Select the Set-Up language	1-7
Select the emulation mode terminal type	1-8
Select the keyboard language	1-8
Select the communication/printer port configuration	1-9

Select the communication word size	1-9
Select the communications parity	1-10
Select the communication transmit speed	1-10
Select the communication receive speed	1-11
Select the printer type	1-11
Save your settings	1-12
Restore the settings	1-12
Exit the Set-Up menu	1-12

Desktop Features **2-1**

Invoking Desktop Features	2-1
Overview	2-1
Clock feature	2-2
Calculator feature	2-3
Show Character Sets feature	2-4
Banner message.....	2-4

3 Maintenance and Troubleshooting **3-1**

Cleaning your Video Terminal.....	3-1
Cleaning the Screen	3-1
Cleaning the Keyboard	3-1
Troubleshooting	3-1
Identifying and Correcting Problems.....	3-1
Troubleshooting Table.....	3-2
Disposing of your Terminal.....	3-4
Installing the ROM Cartridge.....	3-4
Installing and Removing the ROM Cartridge	3-4

4 Defining Keys **4-1**

Define Key Editor	4-1
Moving Standard Functions	4-1
Customization.....	4-2
Modifier Keys	4-2

Creating a New Function.....	4-2
Correcting a Mistake.....	4-3
Examples of Uses.....	4-3

A Specifications A-1

Video Terminal.....	A-1
Acoustic Noise	A-6
Flame Retardants.....	A-8
PVC	A-8
Asbestos	A-8
Ozone Depleting Substance.....	A-8

B Keyboard Function Keys B-1

User Definable Keys.....	B-1
Local Functions	B-1
Compose Characters.....	B-6



Preface

Overview

This guide is for users who wish to install and configure the VT510 video terminal. This guide describes how to connect cables and enter the Set-Up Menu to make changes, as needed. This guide also has reference tables for troubleshooting, specifications, and compose sequences.

For more detailed information on programming the terminal, refer to the *VT510 Video Terminal Programmer Information*. See the inside back cover for ordering information.

Environment

This product has been designed and manufactured to minimize the impact to the environment. The packaging is recyclable and the terminal can be returned for proper disposal.

Before you Start

Ensure that you have received the following:

- Video terminal
- Keyboard
- Power cord, if not attached to the terminal unit

A small flat-blade screwdriver may be needed to install the communication or the printer cables.

Obtain the following information before installing your VT510 video terminal. Write any changes to the default settings in the column on the right.

Information Needed	Obtain From...	Changes to Default Setting
The keyboard country language that you have.	Bottom of the keyboard	
Terminal Emulation: DEC VT , PCTerm, ADDS, SCO, TVI, WYSE	System Manager	
Communication Information: Word size: 8 bits , 7 bits Parity: none , even, odd, mark, space Transmit speed: 9600	System Manager	
Printer Information: Printer type: DEC ANSI , IBM ProPrinter, DEC + IBM Printer serial speed: 4800	System Manager	

The factory defaults are in **boldface** type.

Conventions

The following conventions are used in this document:

Convention	Meaning
Shift+Tab	Indicates two keys that you must press in combination. Press and hold the first key while you press the second key.
Shift-Enter	Indicates two keys that you must press in sequence. Press and release the first key before you press the second key.
Caps Lock+Alt+F11	Indicates three keys that you must press in combination, hold the first two down while pressing the third.
terminal	Describes the VT510 video terminal
Display	Menu items are in boldface type.
	Provides general information
Caution	Provide information to prevent damage to equipment.
Warning	Provides information to prevent injury.

Proper Setup and Use

Important Information: Certain recent scientific literature suggests that poor posture, work habits, or office equipment setup may cause injuries. Other literature suggests that there is no cause and effect. Because the safety of our users is a great concern, it is important to take the precautions described in Table 1.

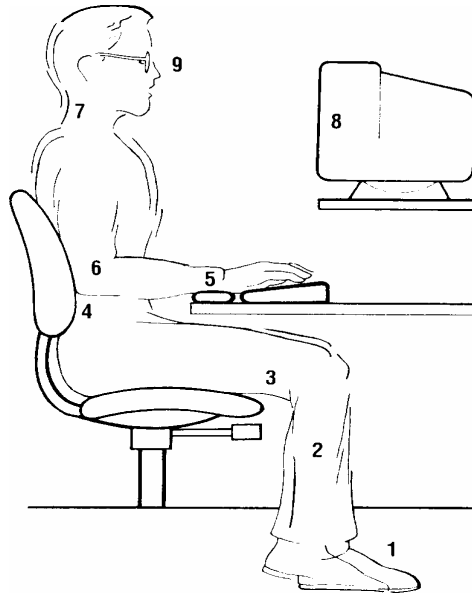

Table 1 Recommendations for Proper Setup and Use

Adjust	So that ...
Chair	1 Feet are flat on the floor or footrest, if needed.
	2 Legs are vertical forming a right angle to the floor.
	3 Your weight is off your thighs and are in a horizontal position. Keep the back of your knees away from the seat so you do not compress the area behind them, which could restrict the blood flow.
	4 Your upper body is erect and your lower back is supported with a backrest.
Keyboard	5 Your wrists are straight and do not flex more than 15°. They may be supported but should not rest on sharp edges.
	6 Upper arms are straight down at your sides, elbows are close to your sides and support your arm weight. Forearms are at a 70° to 90° angle.

Table 2 (Cont.) Recommendations for Proper Setup and Use

Adjust	So that ...
Head	7 Your neck is not strained. Your head should incline downward, but no more than 15° to 20°.
Terminal	8 Eye level and at the correct distance for proper vision.
Eyes	9 Avoid eye fatigue, which can be caused by glare, image quality, uncomfortable furniture, eye height, and uncorrected vision. If you cannot read the screen at different distances, you may need special glasses. Relax your eyes periodically by looking at distant objects.
Work Breaks	Take periodic work breaks. Morning, lunch, and afternoon breaks meet most recommendations. Take advantage of work breaks to move around and do other movements.
Noise	Keep background noise at a minimum. Background noise above 65 dBA is tiring. Sound-absorbing materials, such as curtains, carpeting, and acoustic tile, can help reduce background noise.
Lighting	Avoid direct lighting or sunlight on the screen, which causes glare and reflections. This terminal screen has an antiglare treatment to reduce glare. Place lighting behind or to the side of your work area, and distribute the lighting evenly on your work area. Adjust the brightness and the contrast controls as needed.
Temperature	20°C to 23°C (68°F to 74°F)
Humidity	30% to 70%
Ventilation	Provide adequate air ventilation for equipment operation and to avoid fatigue.
Space Between Terminals	More than 70 cm (28 in.) enter to center, preferable more than 152 cm (60 in.).



Warning: If you experience pain or discomfort during use of the terminal, then take a substantial break and review the instructions for posture and work habits. If the pain or discomfort continues after resuming use of the terminal, then discontinue use and report the condition to your job supervisor or physician.

Installation and Set-Up

Install the tilt/swivel stand

1. Carefully set the terminal face down.
2. Insert the hooks on the stand into the slots at the bottom of the terminal.
3. Slide the stand to the right until it is locked by the two tabs at the bottom of the terminal. (To remove the stand, press the two tabs.)

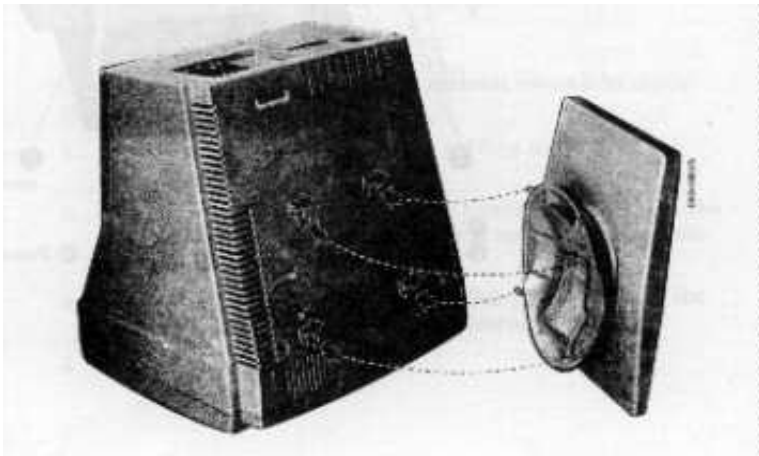

Install your terminal

Connect the cables to the terminal

To install your terminal, connect the cable to the terminal as shown.

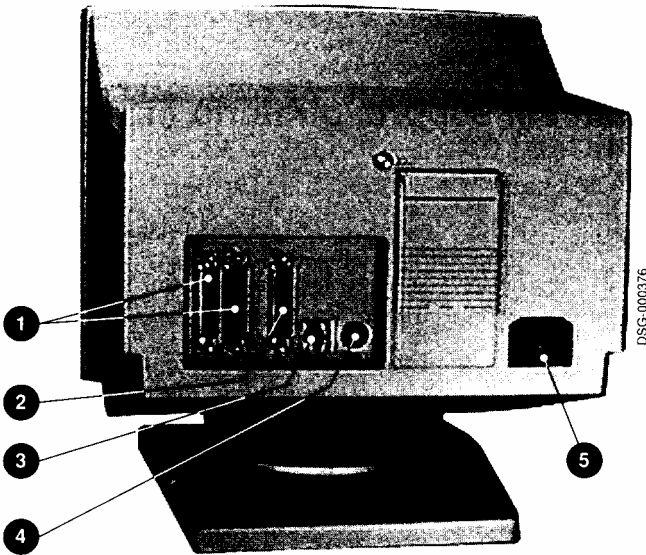

- ❶ Comm 1 (male or female),
- ❷ Parallel,
- ❸ Comm 2,
- ❹ Keyboard,
- ❺ Power Cord.

Plug in the power cord and push the power switch on

The terminal will beep indicating that the power is on.



Set the Brightness and Contrast controls

If necessary, set the brightness and contrast controls by doing the following:

1. Set both controls to maximum by turning controls all the way to the right.
2. Adjust the brightness control ② by turning the control to the left until the background raster is not visible. This sets the black level.
3. Adjust the Contrast control ① by turning the control to the left to set the white level for conformable viewing.
4. Repeat steps 2 and 3 as needed.

“Selftest OK” appears on the screen

The terminal takes a few seconds to warm up and complete its power up self-tests. Then, the terminal should display **“Selftest OK.”** If a problem occurs, go to Chapter 3.

Set up your terminal

Use Set-Up to examine or change the terminal operating features, such as the transmit speed, receive speed, or the language. The Set-Up menus in this section will get you started in operating the terminal. Only the basic Set-Up feature is performed with this procedure. There are many more Set-Up features in the terminal that you may wish to change.

Before changing the Set-Up features, contact your System Manager, if necessary, for information on the terminal type, terminal ID to host, and the communication settings.

Printer operations are suspended upon entering Set-Up and are resumed upon exiting Set-Up.

Entering Set-Up

To enter Set-Up, perform the following procedure:

On a ...	Press ...	Refer to ...
ANSI-style keyboard	F3	Figure 1-1
PC keyboard	Caps Lock+Print Screen or Caps Lock+Sys Rq	Figure 1-2

Moving within a Set-Up Menu

Use the arrow keys (←, →, ↑, ↓) to move among the menus or within a list or to select buttons.

In a menu ...	Indicates ...
?	A pull-right menu is available.
...	A dialog box is available for you to specify more information.
● a ○ b ○ c	The menu item with the filled-in circle is enabled. Only one of these items can be enabled at a time.
<input checked="" type="checkbox"/>	The menu item with the check box is enabled.

Press **Enter**, **Return**, **Do**, or **Select** to start the action or to choose the currently highlighted feature.

A dimmed menu item does not apply to the currently selected mode.

Keyboards

A DEC VT keyboard (Figure 1-1) and a PC keyboard (Figure 1-2) differ in the placement of some of the keys, such as the arrow keys. A DEC VT keyboard has 20 function keys (F1 – F20) above the main keypad, while a PC keyboard has 12 function keys (F1 – F12).



Keyboards from other manufactures may function differently because of differences in their implementation of the PC keyboard standard.

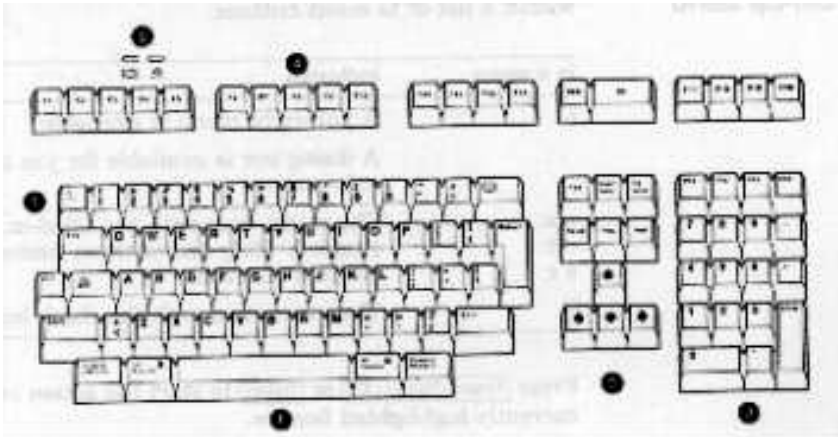

Figure 1-1 – DEC VT Keyboard Layout

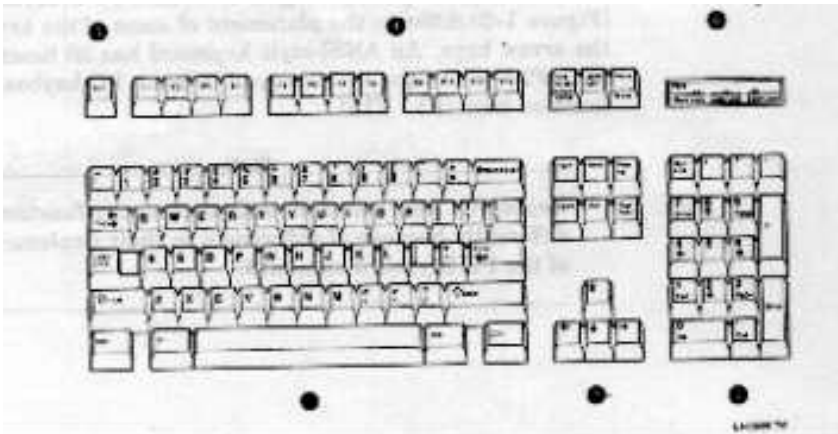
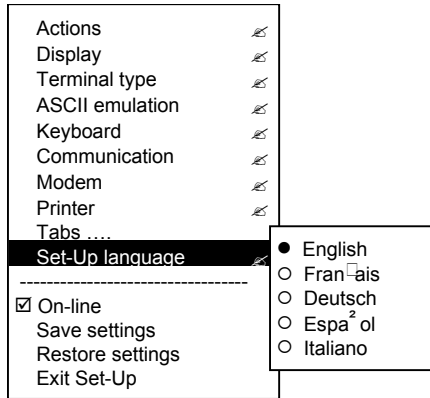

Figure 1-2 – PC-Style Keyboard Layout

① Main keypad, ② Editing keypad, ③ Numeric keypad, ④ Function keys, ⑤ Escape key, ⑥ Indicator lights.

Select the Set-Up language

This language selection is for set up only and does not affect the keyboard, the character set, or the printer settings. As you make changes to some Set-Up parameters, the Set-Up summary line will reflect those changes.



S1=comm1 9600N81 ISO Latin-1 North American VT510

1

2

3

4

5

1 Port selected, 2 Transmit speed (9600), Parity (N), Word size (8), Stop bits (1), 3 Character set, 4 Keyboard language, 5 Emulation mode.

Select the emulation mode terminal type

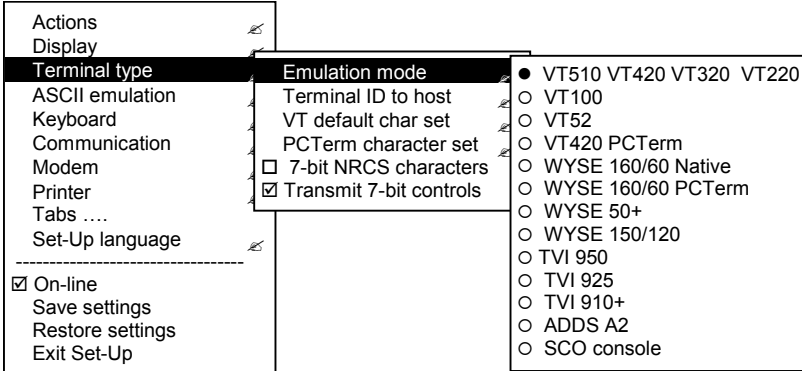

Select the keyboard language

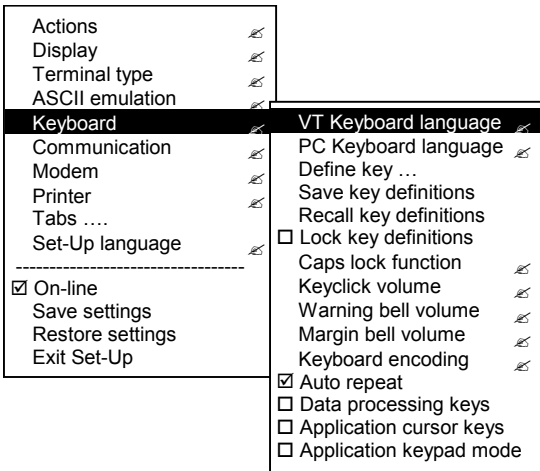

Select the communication/printer port configuration

Actions	✎		
Display	✎		
Terminal type	✎		
ASCII emulation	✎		
Keyboard	✎		
Communication	✎	Port select	<input checked="" type="radio"/> S1=comm1 print=comm2 <input type="radio"/> S1=comm1 print=paralle <input type="radio"/> S1=comm2 print=comm1 <input type="radio"/> S1=comm2 print=paralle
Modem	✎	Word size	
Printer	✎	Parity	
Tabs	✎	Stop bits	
Set-Up language	✎	Transmit speed	
-----		Receive speed	
<input checked="" type="checkbox"/> On-line		Transmit flow control	
Save settings		Receive flow control	
Restore settings		Flow control threshold	
Exit Set-Up		Transmit rate limit	
		Fkey rate limit	
		<input checked="" type="checkbox"/> Ignore Null character	
		<input type="checkbox"/> Local echo	
		<input type="checkbox"/> Half duplex	
		<input type="checkbox"/> Auto answerback	
		Answerback message	
		<input type="checkbox"/> Answerback canceled	

Select the communication word size

Actions	✎		
Display	✎		
Terminal type	✎		
ASCII emulation	✎		
Keyboard	✎		
Communication	✎	Port select	
Modem	✎	Word size	<input checked="" type="radio"/> 8 bits <input type="radio"/> 7 bits
Printer	✎	Parity	
Tabs	✎	Stop bits	
Set-Up language	✎	Transmit speed	
-----		Receive speed	
<input checked="" type="checkbox"/> On-line		Transmit flow control	
Save settings		Receive flow control	
Restore settings		Flow control threshold	
Exit Set-Up		Transmit rate limit	
		Fkey rate limit	
		<input checked="" type="checkbox"/> Ignore Null character	
		<input type="checkbox"/> Local echo	
		<input type="checkbox"/> Half duplex	
		<input type="checkbox"/> Auto answerback	
		Answerback message	
		<input type="checkbox"/> Answerback canceled	

Select the communications parity

The screenshot shows a multi-level menu. The main menu has options: Actions, Display, Terminal type, ASCII emulation, Keyboard, **Communication**, Modem, Printer, Tabs ..., and Set-Up language. The 'Communication' submenu is open, showing: On-line (checked), Save settings, Restore settings, and Exit Set-Up. The 'Parity' option is selected, opening a sub-menu with radio button options: None (selected), Even, Odd, Even, unchecked, Odd, unchecked, Mark, and Space. Other options in the 'Parity' sub-menu include Stop bits, Transmit speed, Receive speed, Transmit flow control, Receive flow control, Flow control threshold, Transmit rate limit, Fkey rate limit, Ignore Null character (checked), Local echo, Half duplex, Auto answerback, Answerback message, and Answerback canceled.

Select the communication transmit speed

The screenshot shows the same multi-level menu as above. The 'Communication' submenu is open, and the 'Transmit speed' option is selected, opening a sub-menu with radio button options: 115.2K baud, 76.8K baud, 57.6K baud, 38.4K baud, 19.2K baud, 9600 baud (selected), 4800 baud, 2400 baud, 1200 baud, 600 baud, and 300 baud. Other options in the 'Transmit speed' sub-menu include Receive speed, Transmit flow control, Receive flow control, Flow control threshold, Transmit rate limit, Fkey rate limit, Ignore Null character (checked), Local echo, Half duplex, Auto answerback, Answerback message, and Answerback canceled.

Select the communication receive speed

The screenshot shows a terminal menu with the following structure:

- Actions
- Display
- Terminal type
- ASCII emulation
- Keyboard
- Communication**
- Modem
- Printer
- Tabs
- Set-Up language

Below the menu, there are options: On-line, Save settings, Restore settings, Exit Set-Up.

The 'Communication' menu is expanded to show:

- Port select
- Word size
- Parity
- Stop bits
- Transmit speed
- Receive speed**
- Transmit flow control
- Receive flow control
- Flow control threshold
- Transmit rate limit
- Fkey rate limit
- Ignore Null character
- Local echo
- Half duplex
- Auto answerback
- Answerback message
- Answerback canceled

The 'Receive speed' sub-menu is expanded to show a list of baud rates:

- Transmit speed
- 115.2K baud
- 76.8K baud
- 57.6K baud
- 38.4K baud
- 19.2.K baud
- 9600 baud
- 4800 baud
- 2400 baud
- 1200 baud
- 600 baud
- 300 baud

Select the printer type

The screenshot shows a terminal menu with the following structure:

- Actions
- Display
- Terminal type
- ASCII emulation
- Keyboard
- Communication
- Modem
- Printer**
- Tabs
- Set-Up language

Below the menu, there are options: On-line, Save settings, Restore settings, Exit Set-Up.

The 'Printer' menu is expanded to show:

- Port select
- Print mode
- Printer type**
- DEC/ISO char sets
- PC character sets
- Print extent
- Print terminator

The 'Printer type' sub-menu is expanded to show a list of printer types:

- DEC ANSI
- IBM Proprinter
- DEC + IBM

Below the sub-menu, there are additional options: Serial print speed, 2-way communication, Transmit flow control, Receive flow control, Word size, Parity, Stop bits.

Save your settings

Select the **Save Settings** menu item, then press **Enter** or **Return**.



Caution: If you disable the Screen Saver feature, an image may etch onto the screen, which may shorten the terminal's useful life.

Restore the settings

To recall the settings that you stored in memory using the **Save Setting** menu item, select the **Restore Setting** menu item and press **Enter** or **Return**.



Restore factory defaults is a selection included in the **Action** menu.

Exit the Set-Up menu

To exit Set-Up, select the **Exit Set-Up** menu item or perform the following procedure:

On a ...	Press ...	Refer to ...
ANSI-style keyboard	F3	Figure 1-1
PC keyboard	Caps Lock+Print Screen	Figure 1-2

Desktop Features

Invoking Desktop Features

Overview

From the **Actions** menu, you can invoke the **Clock**, **Calculator**, **Show character sets**, and **Banner message** features. When the feature is highlighted (displayed in reverse video), press **Enter** or **Return** to enable the feature.

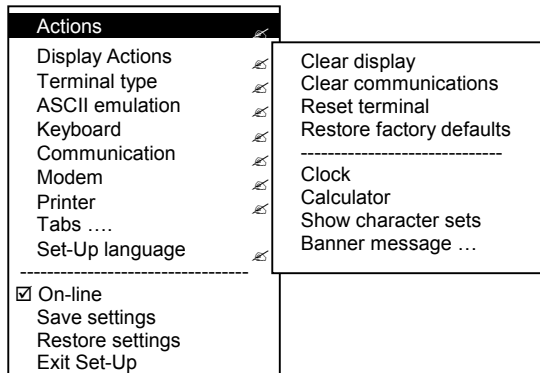

While these desktop features are enabled, other terminal functions are disabled. Press **Ctrl+Z**, **F10**, **Exit**, or **Esc** to exit the feature.

Clock feature

You can enable the **Clock** feature without entering Set-Up by pressing **Caps Lock +Alt+F11** if you are not in an ASCII emulation mode.

The current time is displayed in the status line if this feature is enabled. The format is HH:MM, followed by AM or PM if the 12-hour format is selected. Use the following keys within the clock features:

Key	Function
↓ or Tab	Go to next field.
↑ or Shift+Tab	Go to previous field.
← or →	Move within a field.
Return or Enter	If desired, check the 24-hour format box. For example, before entering 13:00, enable 24-hour format .
A or P	For 12-hour format, set the time to morning by pressing A or P for afternoon.

If the clock feature is enabled, then the alarm sounds for five seconds or until a key is pressed. Each alarm message can be up to 20 characters and will be displayed in the status line until a key is pressed. If the hourly chime is enabled, then the terminal will beep once every hour. In Set-Up, select the **Save settings** menu item to save the time format. The clock feature is disabled when the terminal is turned off.

Calculator feature

You can enable the **Calculator** feature without entering Set-Up by pressing **Caps Lock +Alt+F12** if you are not in an ASCII emulation mode.

In addition to the numbers on the numeric keypad, you use the following keys within the calculator:

Key	Function
H, O, or D	Select hexadecimal H , octal O , or decimal D format.
Arrow keys	Move the position of the calculator on the screen.
Shift	Change the keypad display to allow selecting STO , RCL , 1/x , X² , and Insert Results .
Alt	Change the keypad display to hexadecimal and allow selecting keys A through F of the numeric keypad.
C/E	Clear the entry.
STO	Store the number in the display into memory.
RCL	Recall the number from memory and place it in the display.
Shift-Enter	Insert the result at the current cursor position after exiting the calculator feature.

All calculator math operations have equal priority except $1/x$ and x^2 . If a result is wider than the display, then a rounded number will be displayed. The non-rounded result will continue to be used in subsequent calculations. The decimal point cannot be used with the hexadecimal mode.

Show Character Sets feature

You can enable the **Show character sets** desktop feature without entering Set-Up by pressing **Caps Lock +Alt+F10** if you are not in an ASCII emulation mode. When the character set is displayed, you can use the following keys with this feature:

Key	Function
Next or Prev Page Up or Page Down	Look through the available character sets.
Shift-L	Display the line drawing character set if you are using a VT character set.
Shift-T	Display the technical character set.
Shift-Enter	For the current character set, insert the highlighted character into text at the current cursor position, if you are using a VT character set.

Banner message

From the **Actions** menu, select Banner message ...

1. Press Return or Enter to display a dialog box.
2. Enter our banner message.
3. Press the ↓ to select the **OK** button.
4. Press Return or **Enter** to **Return** to the Set-Up menu.

Maintenance and Troubleshooting

Cleaning your Video Terminal

Cleaning the Screen

Before cleaning the screen, set the terminal power switch to the off position and wait 20 seconds to let the static electricity dissipate. Clean the screen with a video screen cleaner.

Cleaning the Keyboard

If needed, wipe the keys with a soft cloth. Do not allow moisture to get under the keys.

Troubleshooting

Identifying and Correcting Problems

The following can be sources of problems:

- Communications cables
- Host system
- Nearby power or electrical sources

Troubleshooting Table

Use Table 3-1 to identify and correct any problem areas.

Table 3-1 Identifying and correcting problems

Symptom	Possible Cause	Suggestion Solution
Cursor or "Selftest OK" does not display	Brightness or Contrast control is set too low.	Increase the brightness and contrast control setting under the front of the terminal.
	Power cord is not connected.	Connect the power cord to the power source and the terminal. Push the power switch in.
	There is no power.	Use a function outlet.
	The terminal is faulty.	Set the power switch to the off position and contact the service representative.
Screen is blank, but cursor is blinking.	Screen saver is active.	Press any key.
	Signal cable is not connected.	Reconnect the cable.
	Communications port is not set properly.	From the Communication menu item, choose Port select and check the setting for the cable connections.
	Communication speed may be set incorrectly.	Check the communication transmit speed, receive speed, and parity with you system manager; then match them to the Set-Up settings.
	The host system may be faulty.	Contact your system administrator.
Video is off center.	The Earth's magnetic field at your location may be causing the display to shift.	From the Display menu item, choose Screen alignment .

Table 3-1 (Cont.) Identifying and correcting problems

Symptom	Possible Cause	Suggestion Solution
<p>Video display has moving dots and distorted lines. The display rolls or flickers.</p>	<p>There is electromagnetic interference.</p>	<p>Move and electromechanical device, such as a fan or a motor, away from the terminal or move the terminal.</p> <p>CAUTION: Before moving the system, turn the power off and wait 20 seconds to let the static electricity dissipate.</p>
	<p>Refresh rate is too low.</p>	<p>From the Display menu item, choose Refresh rate and select 72 Hz.</p>
	<p>The terminal is faulty.</p>	<p>Set the power switch to the off position and contact the service representative.</p>
<p>The printer will not print.</p>	<p>The printer power is not on.</p>	<p>Turn on the power to the printer.</p>
	<p>The printer cables are not connected.</p>	<p>Check the cables.</p>
	<p>Communication port is not set correctly.</p>	<p>From the Communication menu item, choose Port select and match the setting to the connections on the terminal.</p>
	<p>If you have a serial printer, its speed may be set incorrectly.</p>	<p>From the Printer menu item, choose Serial print speed and match the setting to the one in your printer manual.</p>
<p>Modifier keys remain in effect after released.</p>	<p>Accessibility aid enabled.</p>	<p>Check keyboard indicator line for icon. This feature is enabled by pressing any key modifier key five times. To disable, press and hold a modifier key and then press another key.</p>

Disposing of your Terminal



Warning: If you need to dispose of your terminal, ask a qualified service representative for the proper disposal procedures. Improper disposal could result in personal injury.

Installing the ROM Cartridge

The terminal can accommodate an optional ROM cartridge at the back of the terminal. This ROM cartridge will completely replace the factory-installed software within the terminal for new software versions or special applications.

When an option ROM is not used, the ROM cartridge holder is empty with a cover over it.

Installing and Removing the ROM Cartridge

To install a ROM cartridge:

1. Set the power switch to the off position.
2. Remove the blank cover by lifting the cover from the bottom and gently pulling it straight back.
3. Plug in a ROM cartridge with its attached cover **1**, and close the cover.

If you are having the terminal serviced, then remove and save the ROM cartridge. To remove a ROM cartridge, lift its cover from the bottom and gently pull it straight back.

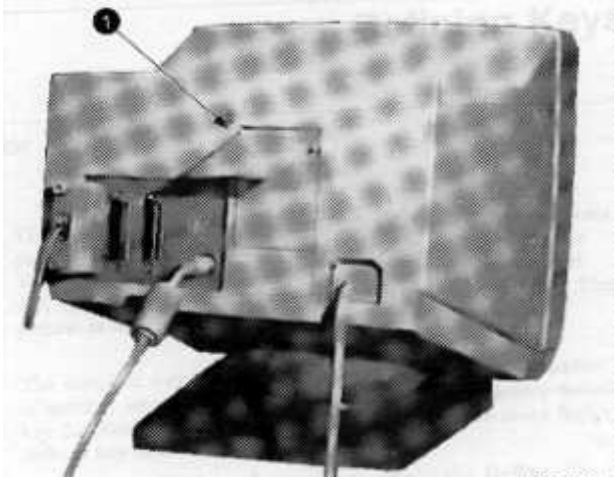

Defining Keys

Define Key Editor

The VT510 provides a powerful Define Key Editor that allows you to modify the function of keys on your keyboard. Since VT510 keystrokes can perform many different functions, it will take some practice to understand how the keys work. This section is an introduction to customizing your keyboard.

Moving Standard Functions

The simplest way to re-program a key is to copy the behavior of another key. This method allows you to move factory default key functions to any position on the keyboard. To move factory default key functions:

1. From the Keyboard menu item, select the **Define key ...** function, and the **Define Key Editor** menu will appear.
2. Press the key for which you want to assign a new behavior.
3. Press the → key to highlight the “Copy of key default” radio button (• Copy of key default) and press **Enter**.
4. Press the key whose factory default behavior is what you want your defined key to do.
5. Press the ↓ key to highlight the OK or Apply pushbutton and press **Enter**.

Customization

If you want to program a key to behave differently than one of the factory defined keys, then you will need to know about the following VT510 key categories:

- Function: Keys used to transmit function key sequences or to perform local terminal functions such as the arrow keys (**←**, **→**, **↑**, **↓**), and **Shift** modifier keys, or the **Set-Up** key.
- Alphanumeric: Keys used to transmit alphanumeric characters.

Modifier Keys

Modifier keys vary from within the function and alphanumeric categories. A modifier key is a key that modifies the behavior of other keys when it is pressed and held down. For example, pressing an alphanumeric key in combination with the **Shift** modified key will normally send the shifted or uppercase characters for that key.

Modifier keys are treated as a special kind of local terminal function. The VT510 function modifier keys are: **Shift**, **Ctrl**, and **Alt**. VT510 alphanumeric keys can also be modified by pressing **Group Shift (Alt Gr** on enhanced PC keyboards) and **Alt+Shift (Shift-2)**. Modifier keys themselves cannot normally be modified by other keys. A key assigned to act as the **Shift** modifier, for example, cannot transmit a functions sequence when pressed in combination with the **Alt** key. Defining a key as a modifier key makes all assignable combinations of that key act as a modifier.

Creating a New Function

To define a new function key:

1. From the **Keyboard** menu item, select the **Define key...** function, and the **Define key editor** menu will appear.
2. Press the key for which you want to assign a new behavior.
3. Press the **←** and **→** keys to highlight the “Function” radio button (**• Function**) and press **Enter**.
4. Press the **↑** and **↓** keys to highlight the modifier combination that you want to define (unshifted, shifted, control, and so on) and press **Enter**.

5. Press the → key to move to the “Select function” scroll box. Press the ↑ and ↓ keys to highlight the desired keystroke function from the list and press **Enter**.
6. Press the ← key to return to the modifier selection.
7. Repeat steps 4 through 6 to define other modifier combinations as desired.
8. Use the arrow keys (←, →, ↑, ↓) to highlight the OK or Apply pushbutton and press **Enter**.

Correcting a Mistake

If you make a mistake or want to start over, select the Cancel pushbutton or select the **Exit Set-Up** menu item. Your changes will not be recognized until you select the OK or Apply pushbutton. To save your key definitions so they will be available the next time you turn on the system power, select the **Save key definitions** menu item for the **Keyboard** menu.

Examples of Uses

Examples of when to create new functions include:

- To change the  key to delete when unshifted and to backspace when shifted
- To disable the Compose, Break, or set-Up key by assigning them to have no function

The Define Key editor can be very powerful if you take the time to learn how to use it. No matter how you define the keys, you can always enter Set-Up by pressing **F3** after powering on. Additionally, you can always restore the factory default settings by invoking the **Actions** menu items.



See the *VT510 Video Terminal Programmer Information* manual to redefine alphanumeric keys or keyboard layouts.

A

Specifications

Video Terminal

The following are the specifications for the VT510 video terminal.

Dimensions

Height 32 cm (12.6 in)

Width 31.5 cm (12.4 in)

Depth 33 cm (13 in)

Weight

7.9 kg (17.4 lb)

Tilt Range

25° (5° forward, 20° backward)

Swivel Range

± 90° (left and right)

Display

Cathode ray tube (CRT) 35 cm (14 in) diagonal antiglare flat-profile screen

Overscan 60 Hz – 16 x 10 font; 72 Hz – 13 x 10 font

Area 800 x 432 pixels with 88 DPI density

Usable area 17 cm (6.7 in) x 23 cm (9 in); 1:1.4 aspect ratio

No. of lines 25, 42, or 53 data lines

Page size Selectable 24, 25, 36, 42, 48, 50, and 72 lines (emulation dependent)

Operating Systems Supported

UNIX, MDOS, OpenVMS, OSF, ULTRIX, VMS, or any other that supports ASCII or ANSI protocols.

Terminal Emulations	ANSI, PCTerm, and ASCII emulations: VT, WYSE. TVI, ADDS, or SCO console.
Character Set Support	Multiple languages using ISO and IBM code pages; Set-Up selectable in five languages
Productivity Features	Local copy and paste Time-of-day clock—sound alarms and display messages Desktop calculator—insert result into text Show character sets—insert character into text.
ROM cartridge support	4-Mbit (512 K byte) customer- installable ROM cartridge at back of system unit that completely replaces the factory installed ROM code for new versions of the terminal's firmware
Electrical Requirements	
AC input voltage	120 Vac only; or 110, 120, 220, 330, 240 auto-sensing (product variant) single phase, 3-wire
Line frequency	47 Hz to 63 Hz
Power consumption	40 watts maximum
Operating Temperature	10°C to 40°C (50°F to 104°F)
Humidity	10% to 90% relative humidity Maximum wet bulb = 28°C Minimum dew point = 2°C (noncondensing)
Keyboard	The following are the specifications for the keyboard.
Keyboard style	LK411/LK412 for ANSI/ANSI WPS style layout; PCXAL for enhanced PC 101/102 style layout; available for most European languages.
Protocol	IBM enhanced PS/2-compatible
Connector	PS/2-style, 6-pin mini DIN
Keyboard keys	All keys are programmable for single characters, character sequences, or local functions.
Nonvolatile memory	768K bytes memory

User-defined key maximum length = 255 bytes

Cables

The following are the specifications for the cables.

Order Number	Length*	Connectors
EIA-232 Serial Communications/Printer Cables		
BC22E-10	3 m (10 ft.)	25-pin D-sub f to
BC22E-25	7.6 m (25 ft.)	25-pin D-sub m
BC22D-xx	xx [†]	25-pin D-sub f to 25-pin D-sub f
EIA-422 Communications Cables		
BC16E-10	3 m (10 ft.)	6-pin MMJ to 6-pin
BC16E-25	7.6 m (25 ft.)	MMJ
Parallel Printer Cables		
BC19M-10	3 m (10 ft.)	25-pin D-sub m to 25-pin D-sub m

* EIA-232 maximum cable length is 15.3 m (50 ft.); EIA-423 maximum cable length is 305 m (1000 ft).

[†] xx = length in feet (10, 25, 50)

Communication/Printer Ports

Serial	<p>Bidirectional serial communication/ printer ports with full modem support at 300 to 115.2K baud:</p> <p>EIA 423 Comm1 (Figure A-1): Two 25-pin D-sub m/f (use one or the other)</p> <p>EIA 232 Comm2 (Figure A-2): 6-pin MMJ</p>
Parallel	<p>Centronics (25-pin D-sub f) parallel printer connector (Figure A-3).</p>

m = male; f = female

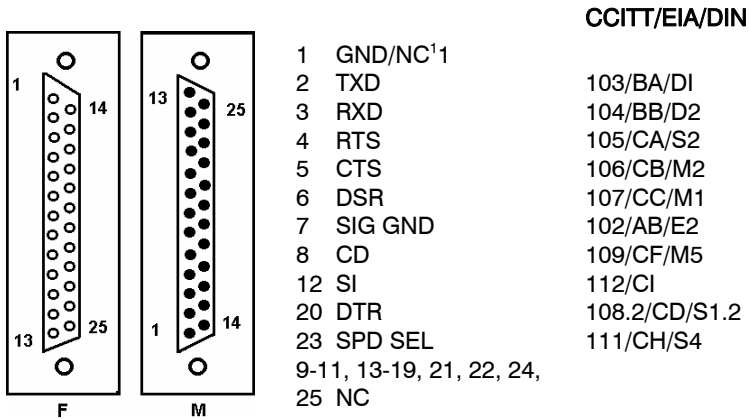

Figure A-1 Comm1—Serial Communication/Printer Ports¹

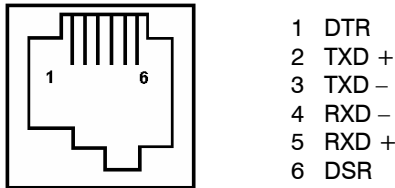
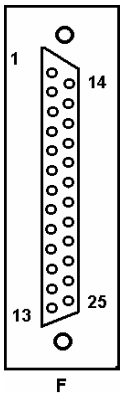

Figure A-2 Comm2—MMJ Port

¹ In North America, pin 1 is open; in international units, pin 1 is ground.
NC = Not connected.



- | | | | |
|---|----------|-------|----------------|
| 1 | STROBE L | 10 | ACKNLG L |
| 2 | DAT<0> | 11 | BUSY |
| 3 | DAT<1> | 12 | PE |
| 4 | DAT<2> | 13 | SLOT |
| 5 | DAT<3> | 14 | AUTO FEED XT L |
| 6 | DAT<4> | 15 | ERROR L |
| 7 | DAT<5> | 16 | INIT L |
| 8 | DAT<6> | 17 | SLCT IN L |
| 9 | DAT<7> | 18-25 | GND |

Figure A-3 — Parallel Printer Port

Power Cords

The following are the specifications for the power cords.

Order Number	Country	Amp	Length
BN19H-2E	Argentina, Australia, New Zealand	15A	3.5 m
BN19W-2E	Central Europe	15A	2.5 m
BN19W-2E	Brazil, Chile, Columbia, Paraguay, Uruguay	15A	3.5 m
BN19P-2E	Canada, U.S.	15A	1.9 m
BN19P-03			3.0 M
BN19K-2E	Denmark	15A	2.5 m
BN19A-2E	Ireland, United Kingdom	15A	2.5 m
BN19S-2E	India, South Africa	15A	2.5 m
BN18L-2E	Israel	15A	2.5 m
BN19M-2E	Italy	15A	2.5 m
BN24T-2E	Switzerland	15A	2.5 m
BN26J-1K or (17-00083-xx)*	Bolivia, Colombia, Ecuador, Mexico, Venezuela	*	1.9 m

* xx = -38 = 125V, 13A
 -39 = 125V, 15A
 -40 = 250V, 10A
 -41 = 250V, 10A

Acoustic Noise

Preliminary declared values per ISO 9296 and ISO 7779:

Product ¹	Sound Power Level		Sound Pressure Level ²	
	L _{wAd} , B		L _{pAm} , dBA	
	Idle	Operate	Idle	Operate
VT510	<3.9	<3.9	<22	<22
PCXAL	NA	6.0	NA	51
PC7XL	NA	5.3	NA	47
LK411	NA	5.6	NA	52

¹ Current values for specific configurations are available from Boundless representatives (1 B = 10dBA.)

² Operator position.

Agency	Type	Standard	Subject
CSA	Safety	CSA 22.2 #950 M1989	Safety of Information Technology Equipment Including Electrical Business Equipment (Canada)
		CSA 22.1	Canadian electrical code
CISPR-22	EMI/RFI	CISPR-22 Class A	Electromagnetic compatibility
EIA	Telcom	EIA 423 EIA 232-E	Serial communications
DOC Canada	EMI/RFI	CSA 108.8	North American Class A version
FCC	EMI/RFI	FCC part 15 Class B	Electromagnetic compatibility
Australia PPT German PPT Japan PPT Sweden PPT	Telecom	CCITT V.24 and V.28	Serial communications
Australia	Safety	AS3260	Australia product safety

5-10 Specifications

Agency	Type	Standard	Subject
TUV	Safety	EN60950 (2nd ed, 1988) EN60950 (Amd 1 & 2, 1990) IEC950(2nd ed, 1991) German X-Ray Act RÖV §5(2) EMKO-TSE (74-SEC) 203/92 SS 436 14 90, MPR II	Safety of Information Technology Equipment Including Electrical Business Equipment GS-Marl (Geprüfte Sicherheit)
TUV	Ergonomic	ISO/DIS 9241-3	VDT Ergonomic Requirements
UL	Safety	UL 544 (2nd ed) UL 1950 (1st ed) NFPA 70	Standard for Medical and Dental Equipment Safety of Information Technology Equipment Including Electrical Business Equipment U.S. National Fire Protection Agency - National Electrical Code
VDE	EMI/RFI	Vfg 243/1991 EN55022 class B	Radio Protection Mark
VCCI (Japan)	EMI/RFI	Class 1	Electromagnetic compatibility



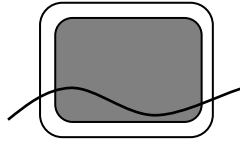

In addition to the standard listed previously, the VT510 low-emissions video terminal complies with the following standards:

Agency	Type	Standard	Subject
NBOSH	EMI/RFI	MPR-2 1990:8	Swedish National Council for Metrology and Testing Display Units
	EMI/RFI	SS 436 14 90	Swedish standard for low emissions

Flame Retardants

The thermoplastic enclosures do not contain polybrominated diphenylether (PBDE) as a flame retardant additive; therefore, they do not emit toxic dibenzofuran and dibenzodioxin gases.

PVC

The plastic enclosures are not made of rigid PVC. The material has a non-halogenated, flame-retardant system and is cadmium free.

Asbestos

Asbestos is not used in this product or in its manufacturing process.

Ozone Depleting Substance

The VT510 is in full compliance with the labeling requirements in the U.S. Clean Air Act Amendments of 1990. It does not contain, nor is it manufactured with a Class 1 ODS, as defined in Title VI Section 611 of this act.

B

Keyboard Function Keys

User Definable Keys

All keyboard keys are programmable by selecting the **Define key function** from the **Keyboard** menu item in Set-Up. They can be programmed to send single characters or character sequences, or to invoke a local function, such as Print Screen.

The function keys have the following key levels: Unshifted, Shifted, Control, Shift Control, Alt, Alt-Shift, Alt-Control, and Alt-Shift-Control.

Local Functions

The keys used to perform local terminal functions differ between the VT keyboard, PC keyboard, and the mode selection. Table B-1 shows the corresponding keys for the default local functions and their function number. This number is used in the DECPAK's host sequence or DECPAK's alternate function to specify a change to that Local Function key. Table B-2 lists other available local functions.

6-2 Keyboard Function Keys

Table B-1 Local Functions

Function Number	Function	VT Keyboard	SCO Console	PC Keyboard VT-Style	PC Keyboard PC-Style	PC Keyboard SCO
0	no function					
1	Hold	F1	Lock+F1	F1	Scroll Lock	
2	Print	F2	Lock+F2	F2	Print Screen	
3	Set-Up	F3	Lock+F3	F3	Lock+Print Screen Lock+Sys Rq Alt+Print Screen	
5	Break	F5	Lock+F5	F5	Lock Pause	
7	Hard Reset	Ctrl+F3	Lock+Ctrl+F3	Ctrl+F3	Ctrl+Lock+ Print Screen	
8	Toggle Autoprint	Ctrl+F2	Lock+Ctrl+F2	Ctrl+F2	Ctrl+Print Screen	
9	Disconnect	Shift+F5	Lock+Shift+F5	Shift+F5	Shift+Lock+Pause	
10	Send Answerback	Ctrl+F5	Lock+Ctrl+F5	Ctrl +F5	Ctrl+Lock+Pause	
11	Print Composed Main Display	Shift+F2	X ¹	Shift+F2	Shift+Print Screen	X
20	Pan Up	Ctrl+↑	X	Ctrl+↑	Ctrl+↑	X
21	Pan Down	Ctrl+↓	X	Ctrl+↓	Ctrl+↓	
24	Pan Prev Page	Ctrl+Prev	X	Ctrl+Page Up	Ctrl+Page Up	
25	Pan Next Page	Ctrl+Next	X	Ctrl+Page Down	Ctrl+Page Down	
30	Copy & Paste Mode	F1 (hold down)	Caps Lock+F1	F1	Scroll Lock	

¹ X means the function is not available in the default SCO state. If there is no "X" in the **SCO Console** column, then this means that the key sequence is the same as the **VT Keyboard** column. If there is no "X" in the **PC Keyboard SCO** column, then this means that the key sequence is the same as the **PC Keyboard PC-Style** column.

Lock means the Lock key, Caps Lock key, or key with lock icon.

Table B-1 (Cont.) Local Functions

Function Number	Function	VT Keyboard	SCO Console	PC Keyboard VT-Style	PC Keyboard PC-Style	PC Keyboard SCO
31	C&P Cursor Left	←		←	←	
32	C&P Cursor Down	↓		↓	↓	
33	C&P Cursor UP	↑		↑	↑	
34	C&P Cursor Right	→		→	→	
35	C&P Start Selection	Select		Home	Home	
36	C&P Copy	Remove		End	End	
37	C&P Paste	Insert Here		Insert	Insert	
38	C&P x [±] Left-to-Right	Select		Home	Home	
41	Shift Modifier	Left or right Shift		Left or right Shift	Left or right Shift	
42	Control Modifier	Ctrl		Left or right Ctrl	Left or right Ctrl	
43	Alt Function Modifier	Left or right Alt		Left or right Alt	Left or right Alt	
44	Start Compose	Left or right Compose			Left Alt+Space	
45*	Group Shift Modifier	Group Shift		Alt+Gr	Alt+Gr	

[±] means the function switches alternately between on and off.

C&P means Copy and Paste.

Table B-1 (Cont.) Local Functions

Function Number	Function	VT Keyboard	SCO Console	PC Keyboard VT-Style	PC Keyboard PC-Style	PC Keyboard SCO
46†	Shift2 Modifier	Alt Shift				
47	Primary KB language	Ctrl+Alt+F1	Lock+Alt+Ctrl+F1	Ctrl+Alt+F1	Ctrl+Alt+F1	See SCO Console
48	Secondary KB language	Ctrl+Alt+F2	Lock+Alt+Ctrl+F2	Ctrl+Alt+F2	Ctrl+Alt+F2	See SCO Console
49‡	±KB language					
51	±Caps Lock State	Lock		Lock	Lock	
52	±Num Lock State			Num Lock	Num Lock	
53	±VT/IBM Style		X	Lock Num Lock	Lock Num Lock	X
54	Extend Kbd Modifier			Lock	Lock	
61	Screen saver					
62	Calculator	Lock+Alt+F12		Lock+Alt+F12	Lock+Alt+F12	
63	Clock	Lock+Alt+F11		Lock+Alt+F11	Lock+Alt+F11	
64	Character table	Lock+Alt+F10		Lock+Alt+F10	Lock+Alt+F10	
65	Transfer results	Shift Enter		Shift-Enter	Shift-Enter	

† The Shift2 Modifier is assigned to the Alt Shift key (German “Right Compose”) when it appears on the corresponding keyboard (German).

‡ Toggles KB language is assigned to the named language key when it appears on the corresponding keyboard (Greek, Hebrew, and Russian).

± means the function switches alternately between on and off.

C&P means Copy and Paste.

Lock means the Lock key, Caps Lock key, or key with lock icon.

Table B-2 Other Available Local Functions

Function Number	Function	Function Number	Function
91	BS	120	Page 0
92	CAN	121	Page 1
93	ESC	122	Page 2
94	DEL	123	Page 3
100	UDK sequence	124	Page 4
105	Soft reset	125	Page 5
106	±Show controls	126	Page 6
111	±Status display	138	Prev Page
112	±Split screen	139	Next Page
113	Raise horizontal split	142	Slow Scroll
114	Lower horizontal split	144	Fast Scroll
115	Adjust window to show cursor	151	±Keyclick
116	± Cursor drag	155	±Block mode
117	± Insert mode	156	Block mode on
119	Home & Clear	157	Block mode off

± means the function switches alternately between on and off.



An Accessibility aid feature allows the modifier keys to remain in effect after they are released. A small icon in the status line indicates its state.

To enable: Press any modifier key five times. **To disable:** Press and hold a modifier key while you press another key.

Compose Characters

The tables at the end of this manual describe how to compose characters for the Multinational and ISO Latin 1 character sets for a VT keyboard.

In the tables, column ...	Represents ...
◆	Characters to be composed.
3-□	A three-stroke key sequence beginning with the Compose key.
2-□	A two-stroke key sequence beginning with a non-spacing diacritical accent key.

Within the tables...	Represents ...
(sp)	A space character.

Canadian-English Danish, Dutch, Hebrew, Hungarian, Italian, Norwegian, Polish, Romanian, Russian, SCS, Turkish-F, Turkish-Q, UK, and US keyboards do not have non-spacing diacritical marks regardless of the character mode.

Contact Boundless Tech Support

1916 Route 96
Phelps, NY 14532-9705

Toll Free 1-800-231-5445
Phone (315) 548-6189
Fax (315) 548-5100

email support@boundlessterminals.com
web www.boundlessterminals.com